

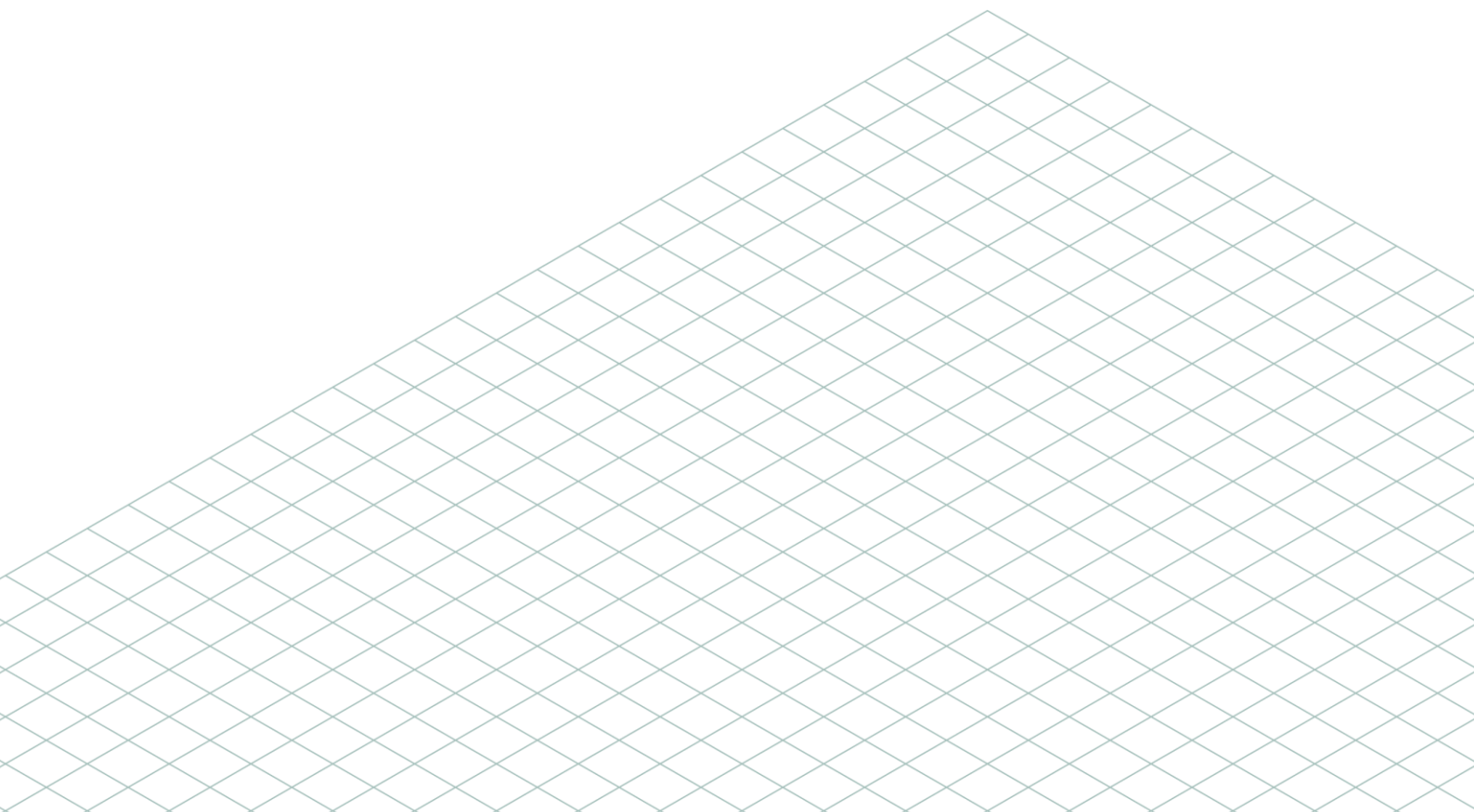

# FRAMECAD Steelwise Updates and How To's



# Contents

---

<b>1</b>	<b>1.1.4.0</b> .....	<b>1</b>
	1.1 Model Filter.....	1
	1.2 Array Stud Colour Option .....	1
	1.3 Labelling of Short Sticks on Detail Sheets.....	1
<b>2</b>	<b>Version 1.1.3.0</b> .....	<b>2</b>
	2.1 IFC Offset Option Added to BSET .....	2
<b>3</b>	<b>Version 1.1.1.0</b> .....	<b>3</b>
	3.1 Raked (Sloped/Pitched) Beams.....	3
	3.2 Job Checklist .....	3
	3.3 Drafter (Designer/Detailer) Name on Detail Sheets .....	4
	3.4 Detail Sheet Reference Marker Input (REF) .....	4
	3.5 Webbed Beam – Wind Beam (Stiffener Plate) Option .....	5
<b>4</b>	<b>Version 1.1.0.0</b> .....	<b>7</b>
	4.1 Steelwise FIM Import .....	7
<b>5</b>	<b>Version 1.0.7.0</b> .....	<b>9</b>
	5.1 RFY Export – Manual Sort Order .....	9
<b>6</b>	<b>Version 1.0.6.0</b> .....	<b>10</b>
	6.1 Upgrading of Jobs Created in Previous Versions of Steelwise.....	10
	6.2 Reshape Smart Panels .....	10
<b>7</b>	<b>Version 1.0.1.0</b> .....	<b>11</b>
	7.1 Introduction .....	11
	7.2 Starting a New Job .....	11
	7.3 Importing a Job Created in FRAMECAD Structure .....	12
	7.4 RFY Export.....	14
	7.5 Tooling Options .....	15
	7.6 Chamfer Tooling .....	17
	7.7 Stick Member Start End Indicator .....	17
	7.8 Gridline Options (GL).....	18
	7.9 Head/Sill Stiffener Extension Option Added .....	18
	7.10 Opening Head and Sill End Jack Option Added (PSET) .....	19
	7.11 Opening Beam Head Split to Base Option Added.....	19
	7.12 Restore Autosave Drawing File .....	20

<b>7.13</b>	<b>Single Saddle Truss Input to Correct Height .....</b>	<b>20</b>
<b>7.14</b>	<b>Stud Setout Options.....</b>	<b>20</b>
<b>7.15</b>	<b>Truss Setout To Face Of Truss (TSET).....</b>	<b>21</b>
<b>7.16</b>	<b>Truss Connections (TC) .....</b>	<b>22</b>
7.16.1	Commands .....	22
7.16.2	Available Options.....	23
7.16.3	How to Use the command .....	23
7.16.4	Listing.....	24
7.16.5	Hyperlinks .....	24
7.16.6	Colour Coding .....	24
7.16.7	Reports .....	24
<b>7.17</b>	<b>3D Rotation Around Reference Marker.....</b>	<b>24</b>
<b>8</b>	<b>How To.....</b>	<b>31</b>
<b>8.1</b>	<b>General.....</b>	<b>31</b>
8.1.1	RESETALL .....	31
8.1.2	A3D - Frames Not Lining Up.....	31
8.1.3	Checklist .....	31
8.1.4	Command Aliases (Shortcuts) Missing .....	31
8.1.5	Command Bar Missing.....	31
8.1.6	Copy.....	32
8.1.7	Creating a Custom Border.....	32
8.1.8	Data File Updates .....	33
8.1.9	DET – Detail/Frame Builder.....	33
8.1.10	ELEVATIONLINE Command Not Recognised.....	33
8.1.11	Export.....	33
8.1.12	File Dialogue Boxes Missing .....	34
8.1.13	How to Input Imperial Measurements.....	34
8.1.14	Importing IFC file into REVIT.....	34
8.1.15	Labelling Issue .....	36
8.1.16	Menus – How to Resolve Missing Menus.....	36
8.1.17	Mirroring Jobs .....	36
8.1.18	Move.....	37
8.1.19	PCB (Calculate Wind) Not Working .....	37
8.1.20	PDF (PDFEXPORT) Bad Fonts.....	37

8.1.21 PDF (PDFEXPORT) Not Working .....	38
8.1.22 REF – Multiple Reference Marker Placement .....	38
8.1.23 Reactors.....	38
8.1.24 Resolve Graphics Performance Issue .....	39
8.1.25 Restoring an 'AutoSave' Drawing .....	39
8.1.26 Open and Save As... Dialogue Boxes Gone .....	40
8.1.27 Scroll Between 3D Views .....	40
8.1.28 SECTION MARK .....	40
8.1.29 SECTIONLINE Command Not Recognised .....	41
8.1.30 SHOW – Engineering Failures .....	41
8.1.31 STRIP – Strip Entity Property Intelligence .....	41
8.1.32 SUM – Report Summary .....	41
8.1.33 -TTD – Truss Builder (Silent).....	41
8.1.34 Importing a Job Created in FRAMECAD Structure .....	41
8.1.35 Using Viewports (Standard IntelliCAD usage not directly related to Steelwise usage) ....	43
8.1.36 VM – Make View .....	43
8.1.37 X – Previous Zoom.....	43
8.1.38 Zone Grouping for Walls and Joists .....	43
8.1.39 ZZ – Toggle Tabs.....	45
<b>8.2 Floor Detailing .....</b>	<b>45</b>
8.2.1 Add or Amend Floor Beams.....	45
8.2.2 Adjusting Floor Joist Web Spacing.....	46
8.2.3 Automatically Hide Layout Layers on PPD (PSET – Options) .....	46
8.2.4 Deep C Floor Joists – Creating RFY File.....	46
8.2.5 Detail Sheet Border Size.....	46
8.2.6 Floor Member Summary – No Ceiling Batten Material Displayed.....	46
8.2.7 Move Joist Labels.....	46
8.2.8 Opening Joist in Detail Space from the Layout.....	46
<b>8.3 Wall Detailing .....</b>	<b>47</b>
8.3.1 Add Lintel Plates to a Frame.....	47
8.3.2 Add Lintel Plates to a Webbed Beam .....	47
8.3.3 Add or Amend Beams in Data File .....	47
8.3.4 ADD – Beam Heights.....	49
8.3.5 Changing the Panel Properties of a Detailed Wall .....	49

8.3.6	Check Load Path onto Walls .....	49
8.3.7	Defined Door Input .....	50
8.3.8	Detail Sheet Border Size .....	50
8.3.9	How to Erase Lintel L Plates and Leave Member Screws .....	50
8.3.10	Inserting Webs into Wall Frames (IW) .....	50
8.3.11	MB vs MC on Raking Walls .....	50
8.3.12	Opening Commands .....	50
8.3.13	Opening Input by Point .....	51
8.3.14	Openings – Label Options .....	51
8.3.15	PCB – Panel Calculate Brace .....	52
8.3.16	Panel Labelling Options (PSET – Options – Labelling Option) .....	52
8.3.17	Post Input Error Message .....	52
8.3.18	Resetting Stud Data .....	53
8.3.19	SB – Show Brick .....	53
8.3.20	SH – Show Heights .....	53
8.3.21	Sill and Head Check .....	53
8.3.22	Stud Design .....	54
8.3.23	Update a Wall in the Detail Sheet When Making Changes to it in the Layout .....	55
8.3.24	Wall Girder Loads .....	55
8.3.25	Wall Location (External/Internal) .....	55
<b>8.4</b>	<b>Roof Detailing .....</b>	<b>56</b>
8.4.1	Add or Amend Roof Loads .....	56
8.4.2	ADD – Truss Members in Detailing Space .....	56
8.4.3	Detail Sheet Border Size .....	57
8.4.4	Gable End Roof Type Truss Locations .....	57
8.4.5	Lengthening and Shortening Trusses Using the Stretch (ST) Command .....	57
8.4.6	Parallel Chord Girder Trusses .....	57
8.4.7	Setting the height of truncated trusses .....	57
8.4.8	TSET – Truss Spacing Types – Truncated Girder Truss .....	57
8.4.9	Truss Bottom Chord Restraints .....	57
8.4.10	Truss Labelling .....	58
8.4.11	TS (Truss Solar) – Solar Panel Input .....	58
8.4.12	TTD – Existing detailed trusses not working .....	58
8.4.13	TUP or LP – Blank Screen on Input .....	58

8.4.14 TUP – Truss Uplift Plan Values .....	59
8.4.15 User Truss Creation .....	59
<b>8.5 Smart Panels .....</b>	<b>59</b>
8.5.1 Not Initialized.....	59
8.5.2 Add an Opening into a Smart Panel.....	59
8.5.3 Rake (Slope or Pitch) a Smart Panel.....	59
8.5.4 How to reshape a Smart Panel on the layout: .....	60
8.5.5 Working on Jobs with Old Ceiling Panels .....	60
<b>9 Steelwise Menu &amp; Commands .....</b>	<b>61</b>

## 1.1 Model Filter

A model filter has been added to the PSET, TSET and JSET dialogue boxes with the option of showing all the available models within a data file or only the producible ones.

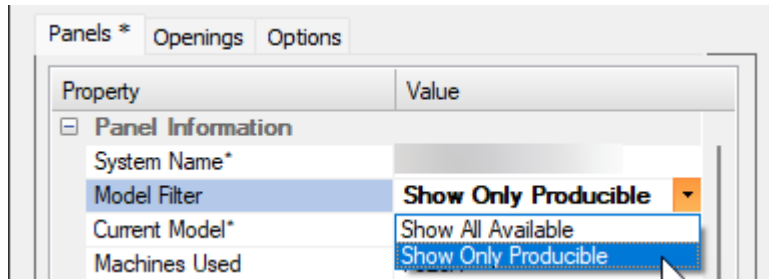

## 1.2 Array Stud Colour Option

The colour for Array Studs can be set as a colour number offset from the standard stud colours by changing the offset value in PSET – Panel Options

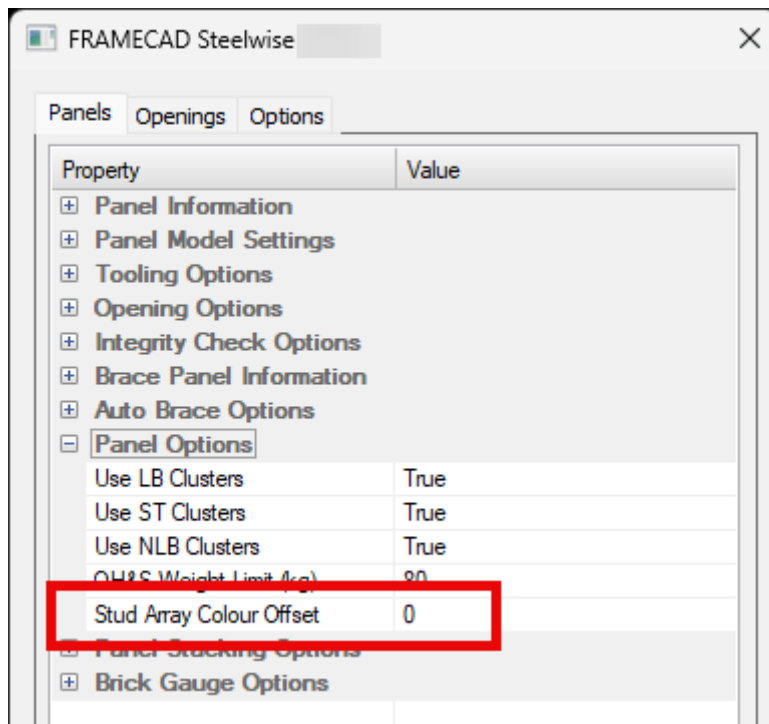

## 1.3 Labelling of Short Sticks on Detail Sheets

An option has been added to PSET, TSET and JSET – Options – Detail Sheet Options called "Label All Sticks". When set to "True" this will label all sticks regardless of the member length. This is a global setting.

## 2 Version 1.1.3.0

---

### 2.1 IFC Offset Option Added to BSET

An option has been added into BSET – Options – IFC Export Options to be able to offset the IFC by user defined X, Y and Z co-ordinate distances.

## 3 Version 1.1.1.0

### 3.1 Raked (Sloped/Pitched) Beams

Beams can now be raked by listing (LI) them and setting the pitch angle in the Lengths & Heights section. Beams can also be raked when using the Rake Wall (PRA - PANEL\_RAKE) command.

For webbed beams, there is also the option to set the ends to be square cut or plumb cut.

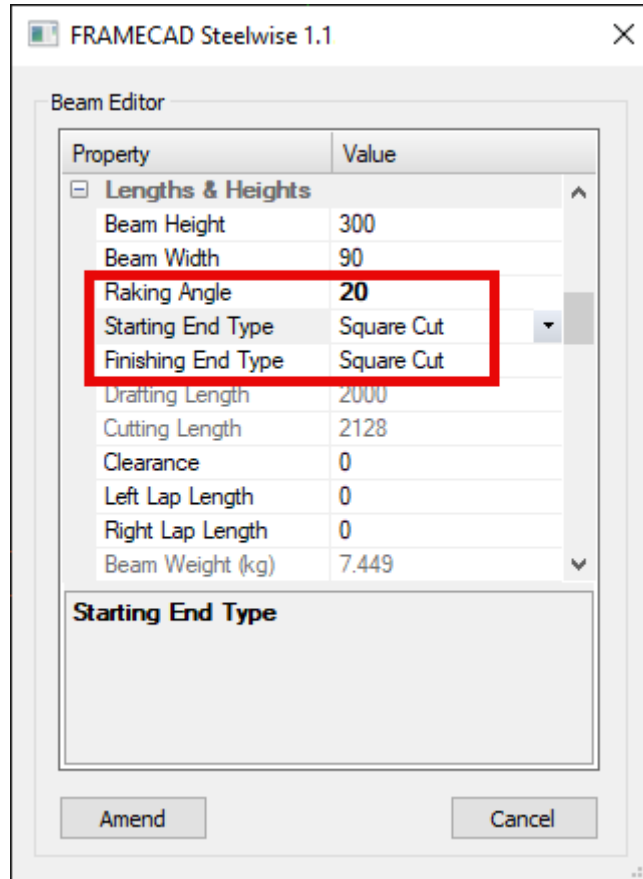

### 3.2 Job Checklist

In both the SUM and REP reports, there is now a 'Checklist' tab. This is designed to be printed out for the factory as a manual checklist for the factory for Rolled, Built and Stacked frames.

ID	Rolled	Built	Stacked	ID	Rolled	Built	Stacked
Wall Frames:							
L1 (1)	<input type="checkbox"/>	<input type="checkbox"/>	<input type="checkbox"/>	L10 (1)	<input type="checkbox"/>	<input type="checkbox"/>	<input type="checkbox"/>
L11 (1)	<input type="checkbox"/>	<input type="checkbox"/>	<input type="checkbox"/>	L12 (1)	<input type="checkbox"/>	<input type="checkbox"/>	<input type="checkbox"/>
L13 (1)	<input type="checkbox"/>	<input type="checkbox"/>	<input type="checkbox"/>	L14 (1)	<input type="checkbox"/>	<input type="checkbox"/>	<input type="checkbox"/>
L15 (1)	<input type="checkbox"/>	<input type="checkbox"/>	<input type="checkbox"/>	L16 (1)	<input type="checkbox"/>	<input type="checkbox"/>	<input type="checkbox"/>
L17 (1)	<input type="checkbox"/>	<input type="checkbox"/>	<input type="checkbox"/>	L18 (1)	<input type="checkbox"/>	<input type="checkbox"/>	<input type="checkbox"/>
L19 (1)	<input type="checkbox"/>	<input type="checkbox"/>	<input type="checkbox"/>	L2 (1)	<input type="checkbox"/>	<input type="checkbox"/>	<input type="checkbox"/>
L20 (1)	<input type="checkbox"/>	<input type="checkbox"/>	<input type="checkbox"/>	L21 (1)	<input type="checkbox"/>	<input type="checkbox"/>	<input type="checkbox"/>
L22 (1)	<input type="checkbox"/>	<input type="checkbox"/>	<input type="checkbox"/>	L23 (1)	<input type="checkbox"/>	<input type="checkbox"/>	<input type="checkbox"/>
L24 (1)	<input type="checkbox"/>	<input type="checkbox"/>	<input type="checkbox"/>	L25 (1)	<input type="checkbox"/>	<input type="checkbox"/>	<input type="checkbox"/>

To print the checklist, go to the 'Checklist' tab and click on the 'Print Current' button at the bottom of the dialogue box.

### 3.3 Drafter (Designer/Detailer) Name on Detail Sheets

An option has been added to display the Drafter name to the Detail Sheets. This option is in BSET – OPTIONS – DRAWING OPTIONS – Add Drafter to Detail Sheet.

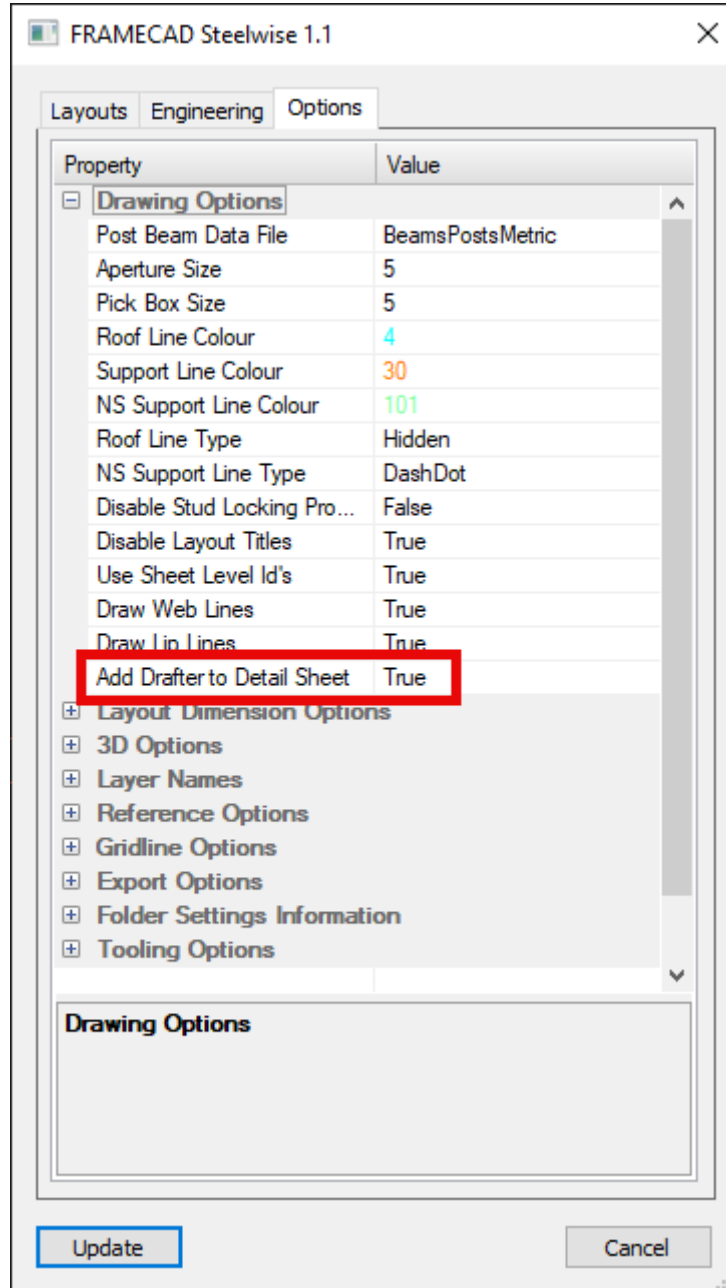

### 3.4 Detail Sheet Reference Marker Input (REF)

The Detail Sheet Reference Markers are essential in linking the frame back to the layout and to ensure that the frame appears in the correct location in the 3D Model Space, and in the correct location if exporting an XML file to FRAMECAD Detailer (or exporting to any other external applications).

The REF\_POINT (**REF**) command now allows the user to reinput a missing reference marker circle (generally at the bottom left-hand end of a wall panel or truss, and top left-hand end of a floor joist) in the

Detail sheet that may have accidentally been deleted during editing. As these can only be deleted by the user, it is therefore up to the user to reinput it back in the same correct location.

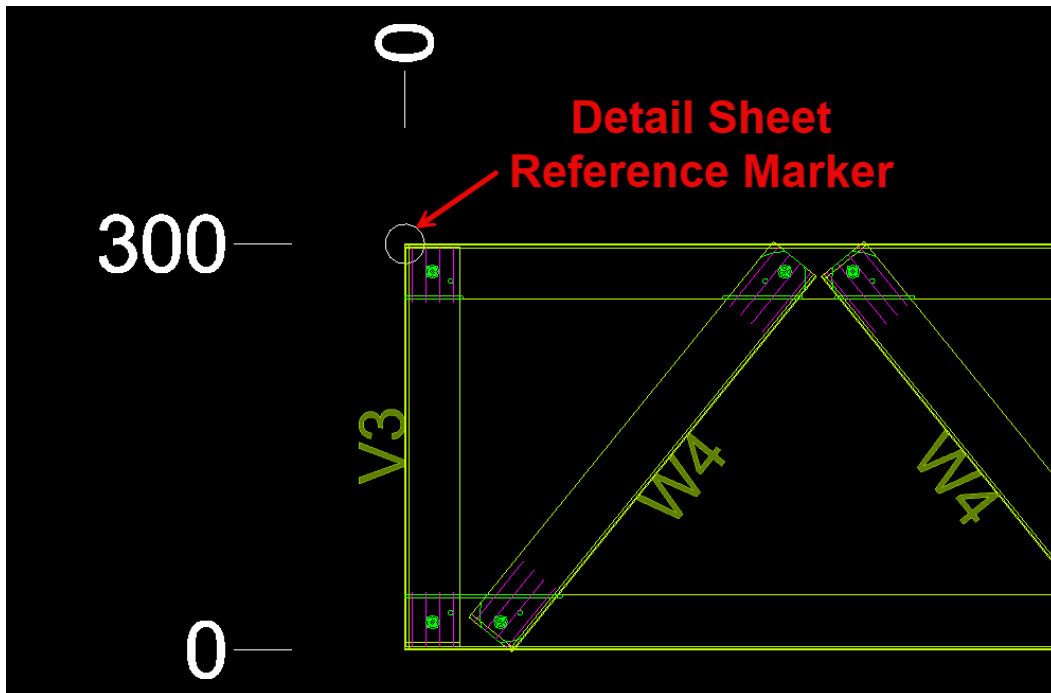

### 3.5 Webbed Beam – Wind Beam (Stiffener Plate) Option

Option added to the Beam input dialogue box and the Beam Editor when listing for Webbed Beams which allows the user to add a Wind Beam (boxed stiffener plate) to the top or bottom or both top and bottom of the beam.

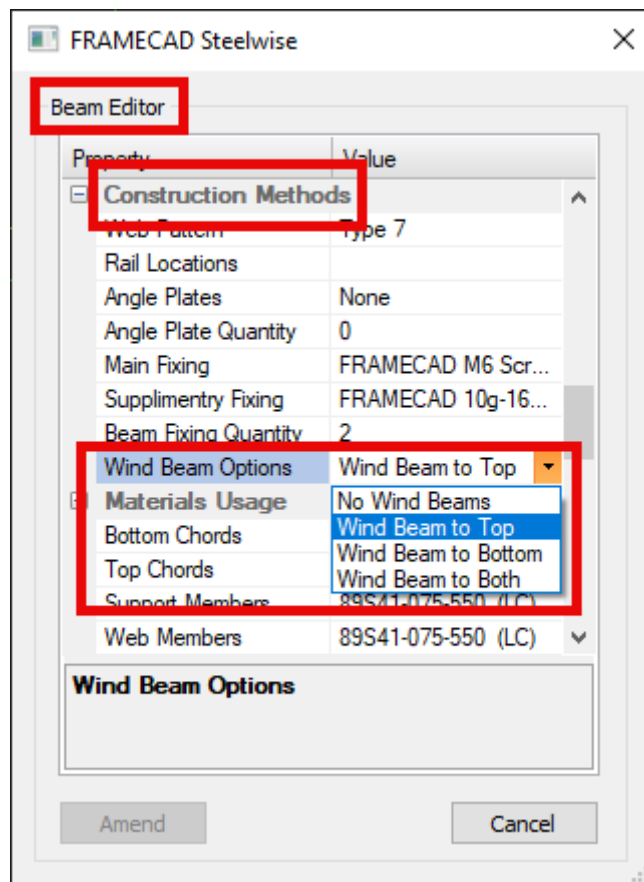
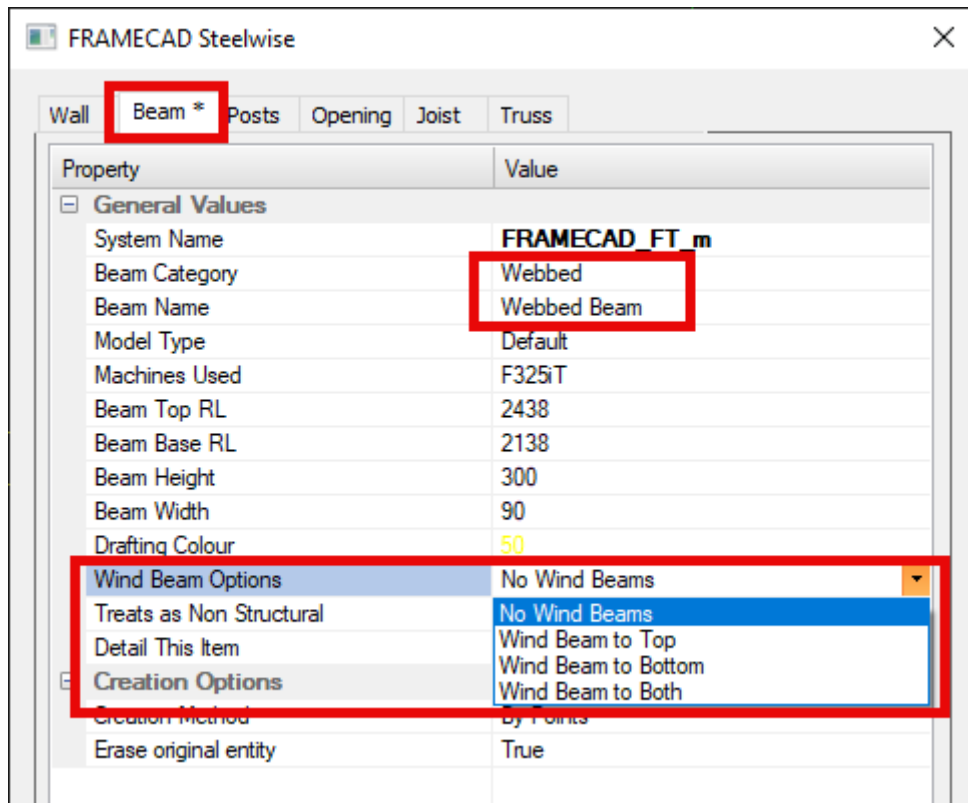

# 4 Version 1.1.0.0

## 4.1 Steelwise FIM Import

In addition to the layouts being imported when importing an FIM file running the FC\_Import command, the detail sheets will also be created for each layout.

- Run BSET to add borders.
- Run the FC\_Import command,
- Select the FIM file and Open
  - If there are not enough borders, a pop-up message will appear to add more borders

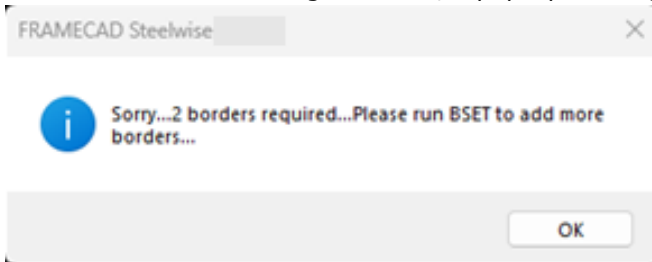

- Set what you want to happen for existing items.
  - 'Import and Replace' will replace any existing frames
  - 'Do not Import' will not import any frames
  - Set the System Name, Model Name and Machine for each level (ie walls, ceiling or floors)

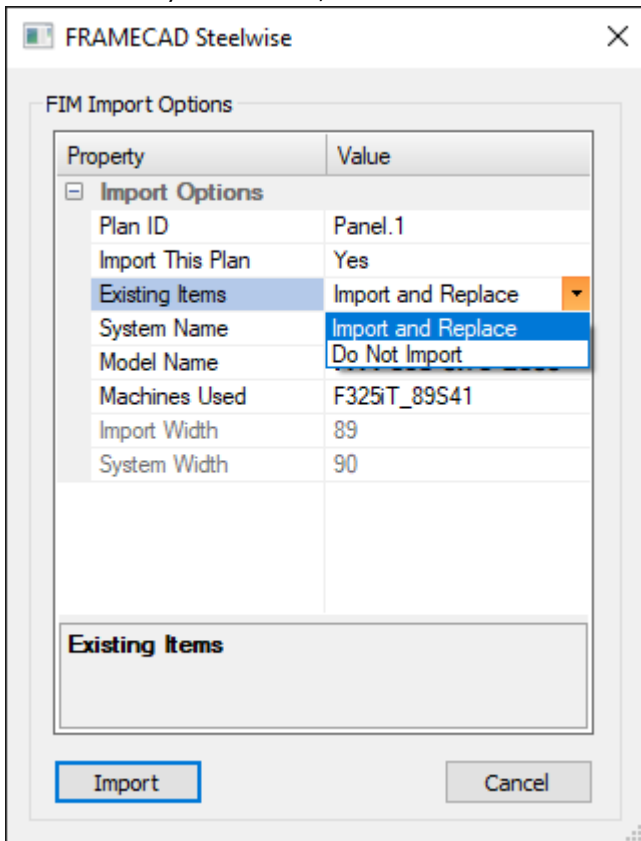

- Click the Import button
- Each frame type that is imported will automatically be built, and a detail sheet will be created.

Please note that these frames have not been engineered, which will be shown by having a stud status of 'Not Checked'



- Frames can be engineered by either running PUA from the Detail Sheet to rebuild the frames or PPD from the Layout to create a new Detail Sheet tab.

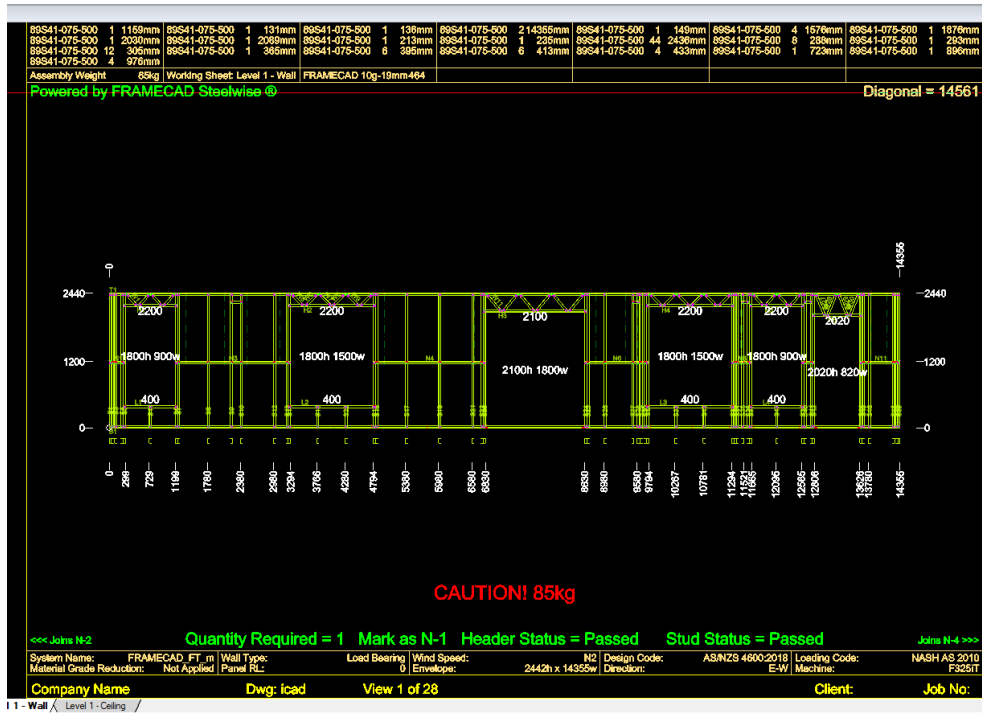

- Once changes have been made, you can export the frames for manufacture by either a Nexa Upload or RFY Export.
- Your frames can also be exported back to Revit or similar software by using the FIMEXPORT command.

### 5.1 RFY Export – Manual Sort Order

In the RFY Export dialogue, the user can now manually move Detail sheet tabs and Frames within those tabs to change the sort order by clicking on an item and dragging it to the desired location.

## 6.1 Upgrading of Jobs Created in Previous Versions of Steelwise

Due to a bug fix in v1.0.6.0, you will now be asked to upgrade any jobs that have been started in previous versions of Steelwise. The changes should only affect jobs created using imperial data files, where the material flange width was being displayed in the detail sheets only, uses the smaller flange size.

## 6.2 Reshape Smart Panels

The Member Divide (MD) command allows the user to be able to add extra grips along any side of a smart panel to then be able to reshape an existing panel.

To use the command:

- In the layout, run the MD (MEMBER\_DIVIDE) command
- Set the number of segments required to divide the side of a panel by (2 will add one extra grip)
- Click on the smart panel
- Once the panel is selected, then click on the segment that you need to add the extra grip(s) to.
- Select the panel to highlight the grips, then click on the grip that you wish to move.
- Stretch the grip to the required location
- **Important: LI the panel and go to 'Other Tools – Rebuild Blocks' and activate the 'Press to Rebuild' button**
- Now your panel is ready to send to the Panel Builder (SPD) and/or Insert Block

Panel with new grip added and existing grip moved:

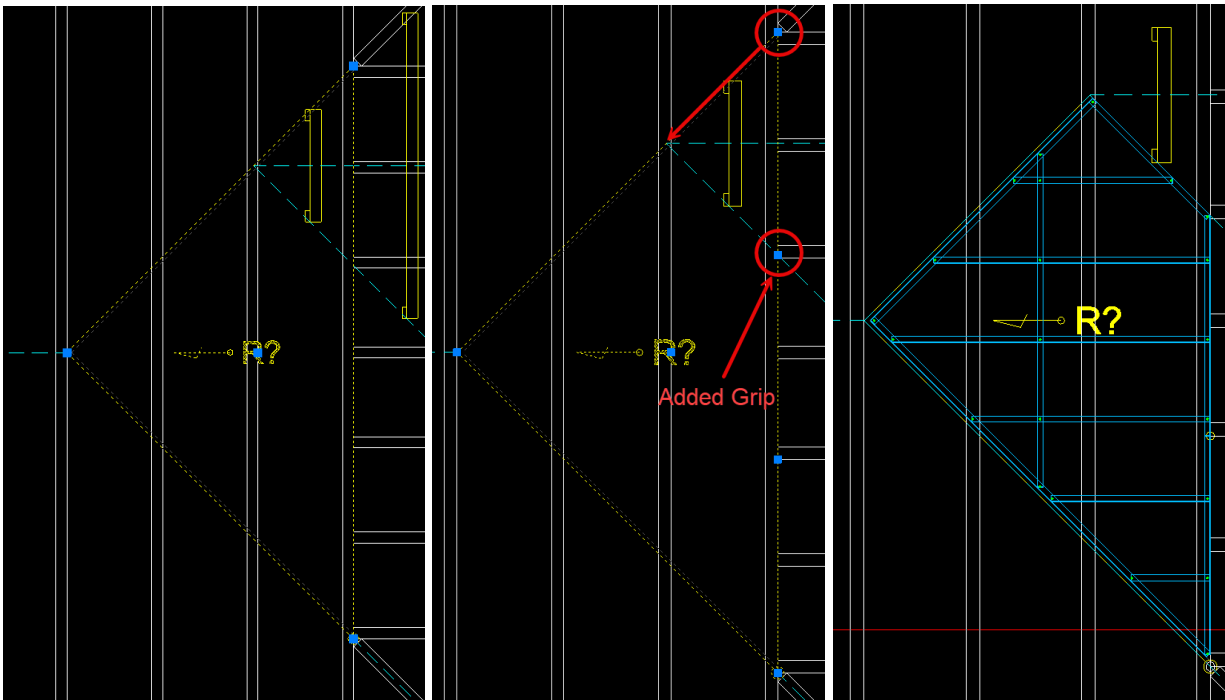

## 7.1 Introduction

For existing FRAMECAD Structure users, FRAMECAD Steelwise has the same basic functionality except that you will no longer need to export an XML which needs to be imported into the Detailer software to then be able to create the RFY machine file.

RFY FRAMECAD machine files are now created straight from Steelwise by running the RFYEXPORT (**RFY**) command.

All the toolings that you would normally see in Detailer are now displayed in Steelwise.

Tooling visualisation can also be turned on or off in **BSET – Options – Tooling Options**.

Tooling is controlled by a Machine SWM data file (this is the filename that you see in settings 'System Name') which in turn, is linked to an SWD data file (this could either be one of the generic FRAMECAD data files or a custom data file).

## 7.2 Starting a New Job

When starting a new job for the very first time and running either the PSET, TSET or JSET commands, the settings dialogue box will open and then a Machine Configurator dialogue will open over the top of it. This dialogue box is to allow you to ensure that the profiles in your SWD file are using the correct machine to start with and to then allow you to reset profiles to be run from a different machine which is capable of producing the same size profile, if another one is available in the dropdown list.

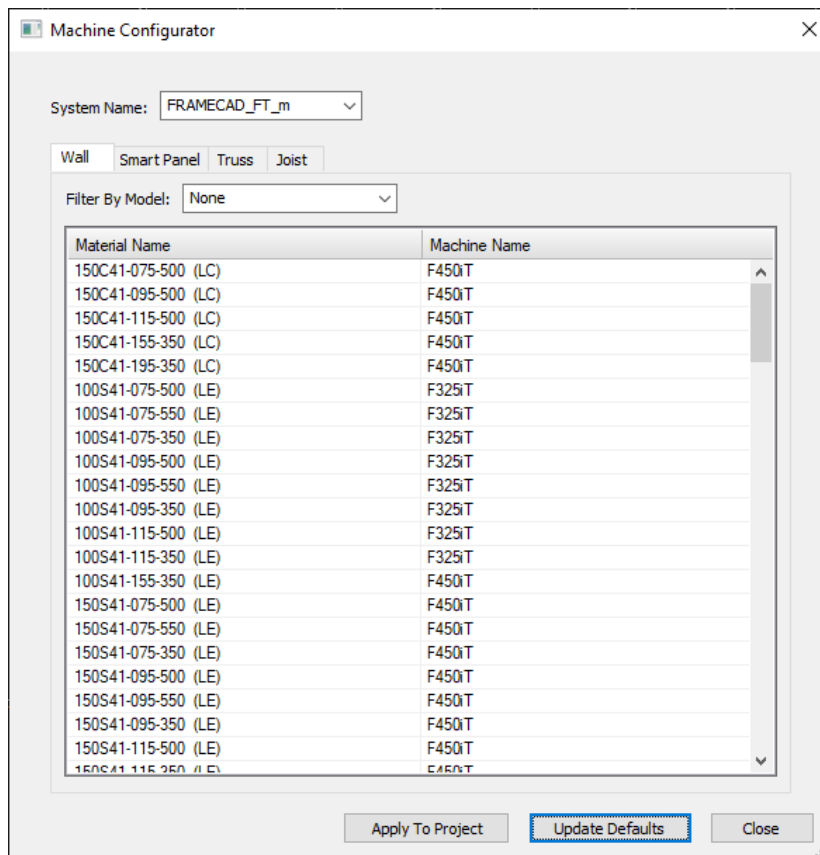

The Machine Configurator shows the System Name and all the material that is able to be rolled and the associated available machines. This allows you to modify which machine is used to run each profile. You will need to do this for each frame type: Wall, Smart Panel, Truss, Joist. The available profiles can also be filtered down by the framing Model.

If the “Do not pop up this window again” option at the bottom of the dialogue is ticked, then the Machine Configurator will no longer pop up for future jobs - but you can still access this dialogue again by either clicking on the ellipsis button to the right of the **Machine Used** in the settings; by clicking on the **Machine Usage** button along the ribbon menu; or by running the **MACHINE\_CONFIG** command.

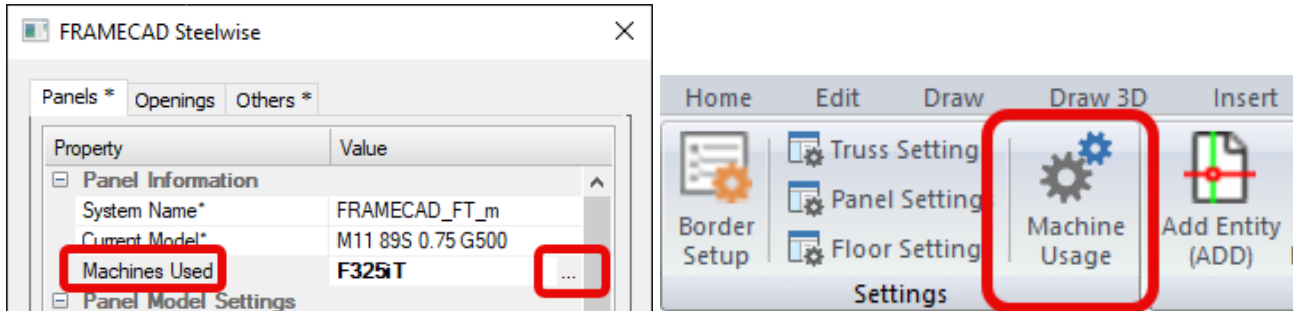

If changes are made within the Machine Configurator, the user has the option to either:

1. **Apply to Project** – this will only apply the changes to the current project.
2. **Update Defaults** – this will create a xxx\_USER.swm machine file in your **C:\ProgramData\FRAMECAD\FRAMECAD Steelwise\Library** directory. This will then take precedence with the newly updated machine option changes whenever a new job is started.
3. **Close** – click on this if you wish to close the Machine Configurator without saving any changes.

If you wish to revert back to the original settings, you just need to delete the xxx\_USER.swm machine file.

### 7.3 Importing a Job Created in FRAMECAD Structure

When opening a job that was started or completed in the FRAMECAD Structure software, a dialogue box will open asking if you wish to '**Upgrade**' the job to be able to be completed/edited in Steelwise, or whether you just wish to '**Open as Regular DWG**' which can be reviewed but unable to be worked on.

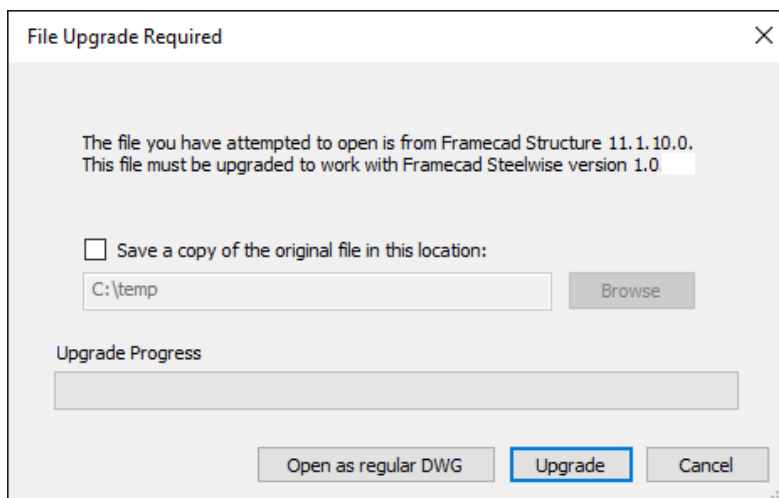

If '**Upgrade**' is successful, then another dialogue will pop-up allowing the user to map the current system used within the job file to any other system which may be present in the user's system Library directory.

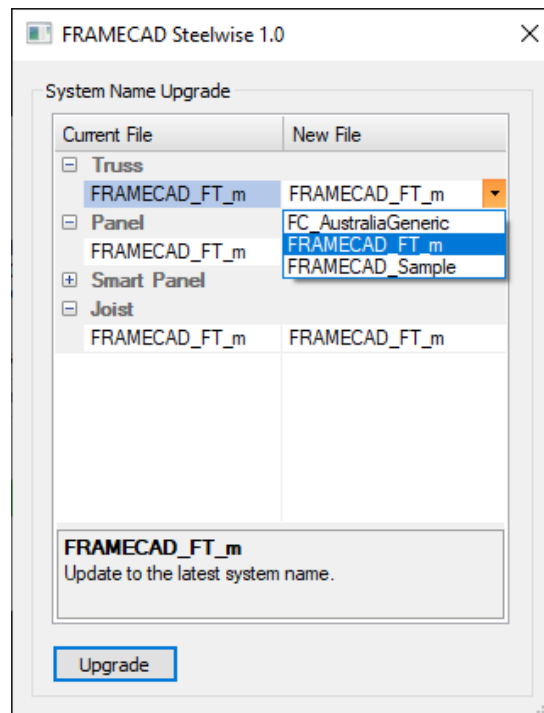

If '**Upgrade**' is selected and a system name within the job doesn't exist in the users Library directory, then another dialogue will pop-up indicating that missing system name.

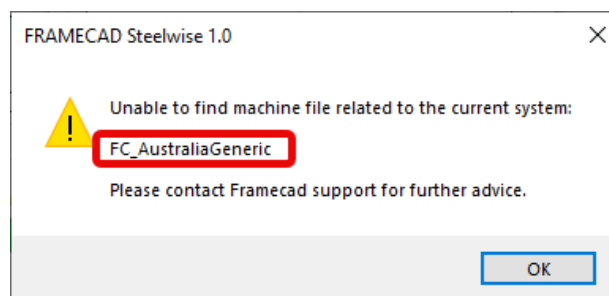

The user will then need to either contact FRAMECAD support to create/provide the necessary data files for that job or they can re-open the file as a regular DWG file for viewing purposes only.

If '**Open as Regular DWG**' is selected, all Steelwise functionality will be disabled for that job except for the following:

- PDFSPOOL (PDF)
- SPOOL\_PRINT (SP)
- FIND\_ITEM (FF)
- VERSION (VER)
- ALL View commands outside of 3D
- ALL Dimensioning Commands

If '**Upgrade**' is successful, then running the LA command in each detail sheet tab will update the title box information and re-associate any lost association links with the layouts.

## 7.4 RFY Export

### Commands:

Global name:	_ RFYEXPORT
Local name:	RFYEXPORT
Alias:	RFY
Space:	Layout and Detailing Space

### Purpose:

Creates an RFY file ready for sending to the rollforming machine.

The RFY output for deep C joists is created straight from the joist layout plan, therefore JJD is not required.

### Process:

- Type RFY then press Enter – this opens the Export RFY dialog box.

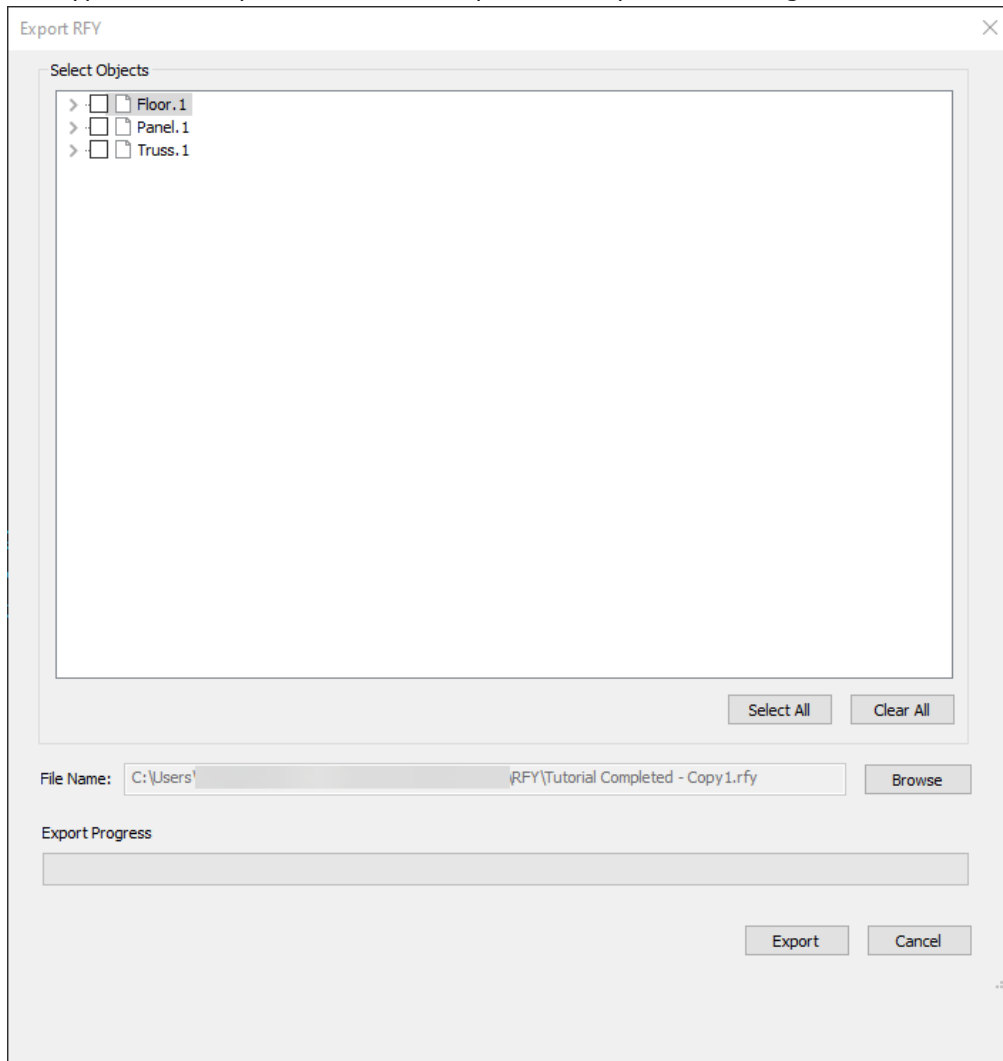

- Select the required tabs/frames to export.
- Edit the required filename and location if required.

- Click on Export to create the RFY file.

**Additional Information:**

All RFY export options that were in Detailer can now be found in BSET – Options – Export Options.

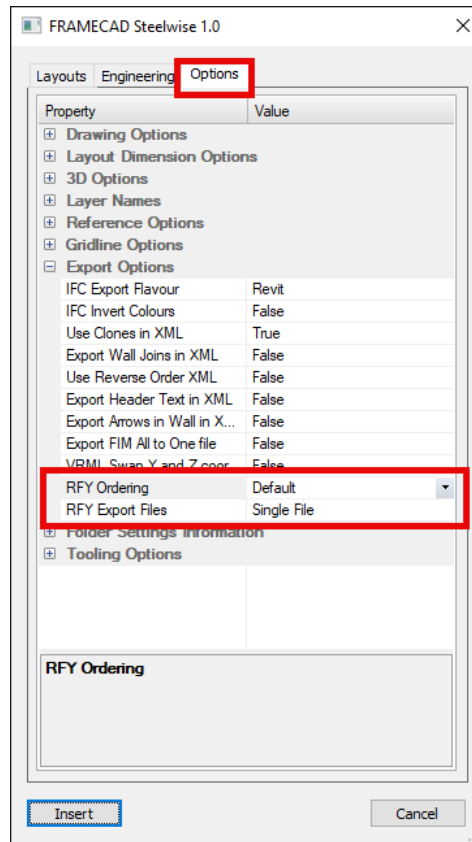

Refer to the **FRAMECAD Steelwise Reference Guide** for additional information.

## 7.5 Tooling Options

The tooling options that were a part of the Detailer software operation are now available in Steelwise and can be accessed in the Options – Tooling Options section in the TSET, PSET and JSET settings dialogue boxes.

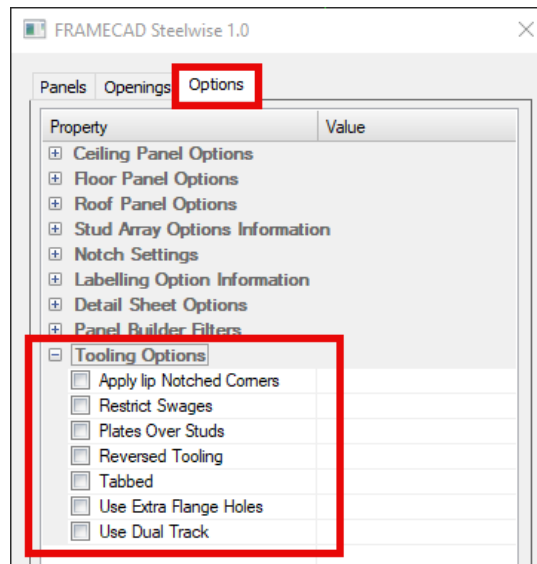

The options available are as follows:

**Apply Lip Notched Corners** – Lip notches both intersecting members at frame corners. Option only available on selected machines.

**Restrict Swages** – Prevents swages where boxing of members occurs.

**Plates Over Studs** – When the end of a noggin member terminates at a stud member, it gets notched inside the stud by default. This tooling option notches the noggin member around the outside of the stud.

**Reversed Tooling** – The horizontal (plate) members are continuous, and the vertical (stud) members get notched. This option would generally be used wherever the horizontal members are required to be the structural members e.g. in certain 'panel roof' situations like gable over frames.

**Tabbed** – This turns on/off the track section fixing tabs for deep cee joist flooring systems. Tabs are only available on selected flooring machines.

**Use Extra Flange Holes** – Places extra flange holes adjacent to dimples for double screwing members. Generally used for webbed joists. Only applicable if machine has flange hole tool available.

**Use Dual Track** – This option needs to be set when detailing frames from a "Stud and Track" machine, where the track (or plate) section width is wider than the stud section width, i.e. where there is no swaging option on the machine. In cases where the machine has the option to do both "stud and track" and swaging, the user will need to be aware of what material they are using when applying this option.

## 7.6 Chamfer Tooling

Although chamfers are added to the end of a member automatically when required, you can also manually add chamfers by listing (LI) a member, then going to the Tooling Options to change the start and end chamfers options.

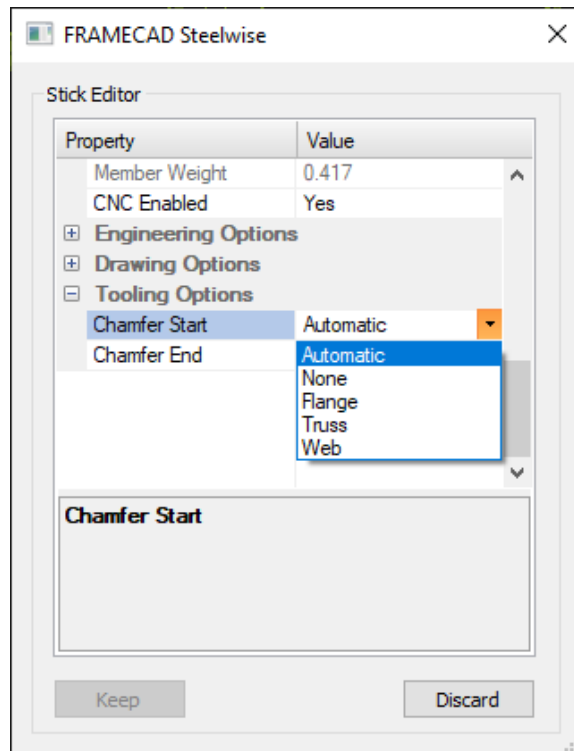

The available options are:

- Automatic      Default setting
- None            Removes chamfer
- Flange          Forces the standard flange chamfer
- Truss            Adds a 'Truss' chamfer to the web side of the member – this tool is a requirement for the 'Linear Truss' system (special tool must be fitted to machine to operate)
- Web              Adds a 'Web' chamfer to the web side of the member – this tool rounds off the corners at the end of a member (special tool must be fitted to machine to operate)

## 7.7 Stick Member Start End Indicator

The stick member start end indicator has been changed to an offset line at the end of the member that comes out of the machine first – the same as what was used in the Detailer software.

Originally this was an arrow shape, but with the introduction of stick member tooling graphics, the arrow symbol could be confused with the chamfer tooling graphics.

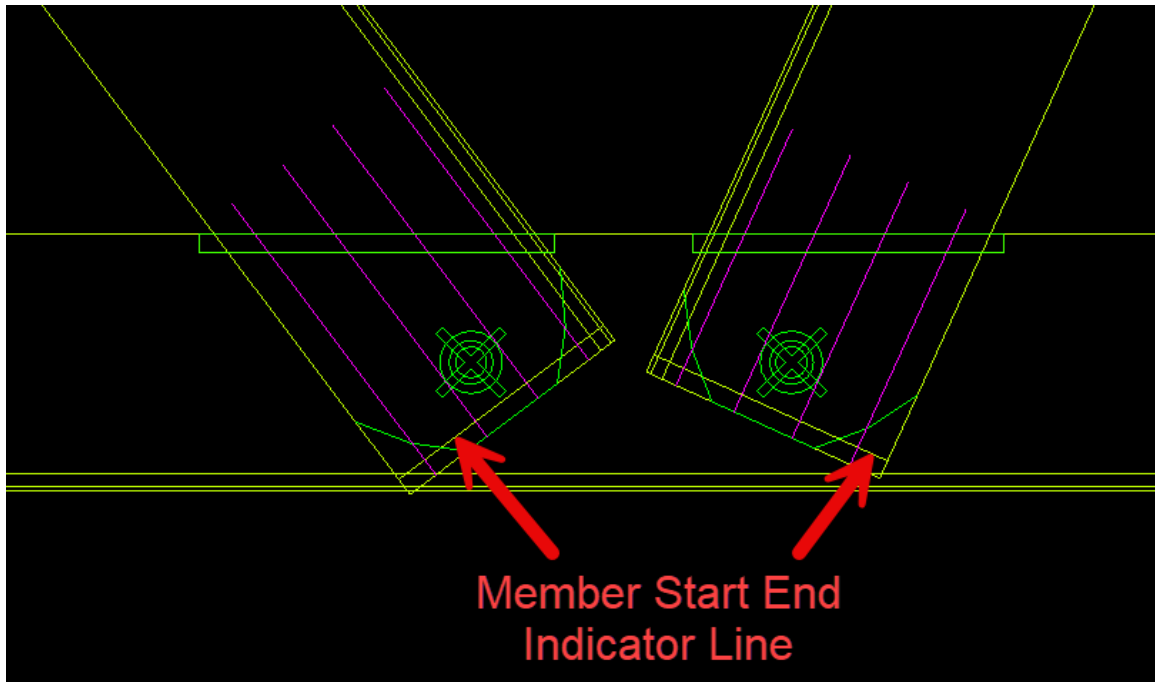

## 7.8 Gridline Options (GL)

Option added to **BSET – Options – Gridline Options** to not extend gridlines to border extents.

Members can also now be extended to a gridline when using the MEMBER\_EXTEND (ME) command.

## 7.9 Head/Sill Stiffener Extension Option Added

Options have been added to the **Opening Editor – Construction Options** which allows the user to specify whether their head and sill stiffeners need to be extended onto the jamb studs. Note that the default setting for this is controlled by the data file settings.

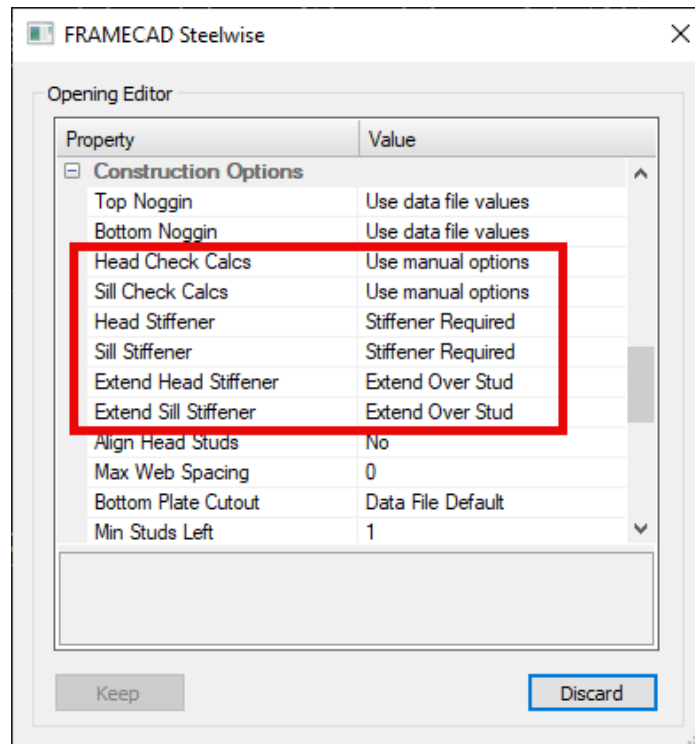

## 7.10 Opening Head and Sill End Jack Option Added (PSET)

Although opening end jacks are always recommended for the design integrity of a webbed header, an option has been added to the **PSET – Opening Options** and the **Opening Editor – Construction Options** which allows the user to alter their **Head and Sill End Jack Stud** requirements if specifically required. Note that the default setting for this is controlled by the data file settings.

As mentioned, the FRAMECAD recommendation is for webbed header end jacks to always be present and to be screwed hard up against the opening jamb studs.

## 7.11 Opening Beam Head Split to Base Option Added

An option has been added to the Opening Editor – Construction Methods which allows the user to set the Beam to Base of Head when a Beam Head type has been set.

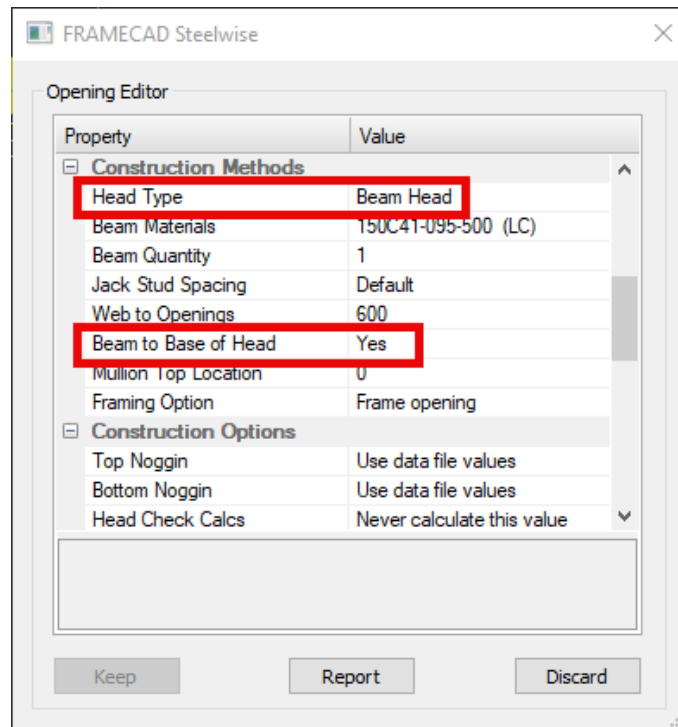

## 7.12 Restore Autosave Drawing File

New command added – **AutoRestore**. This allows the user to easily open the temp file directory where the backup files are located and select and restore the required job file. This can also be found in the Steelwise Help menu.

## 7.13 Single Saddle Truss Input to Correct Height

When inputting a single saddle truss into a roof block, the truss height is automatically adjusted to suit the roof block.

## 7.14 Stud Setout Options

Option added to the ADD – Wall – Other Values dialogue which allow the user to set their preferred Stud Arrangement options and Stud Spacing prior to inputting walls.

Property	Value
Joist Location Tolerance	300
<b>Opening Options</b>	
Opening Head Style	Webbed Head
LB Web to Openings	600
Head and Sill End Jack St...	No end jacks required
<b>Panel Options</b>	
Use LB Clusters	True
Use ST Clusters	True
Use NLB Clusters	True
OH&S Weight Limit (kg)	80
<b>Other Values</b>	
Drafting Colour	20
Extra Truss Span	0
Truss Pitch	23
Extra Floor Span	0
Extra Snow Load	0.00
Stud Arrangement	Single Absolute
Stud Spacing	600
Ext Wall Mass (kPa)	0.11
Int Wall Mass (kPa)	0.22
<b>Creation Options</b>	

## 7.15 Truss Setout To Face Of Truss (TSET)

Option added to **TSET – Truss Spacings – Setout Type** which allows for:

- **Setout to centre** - Trusses set out from the end of the roof block to the centre of the trusses (as per what has always been the default setting)
- **Setout to face** - Trusses set out from the end of the roof block to the nearest side of the trusses.

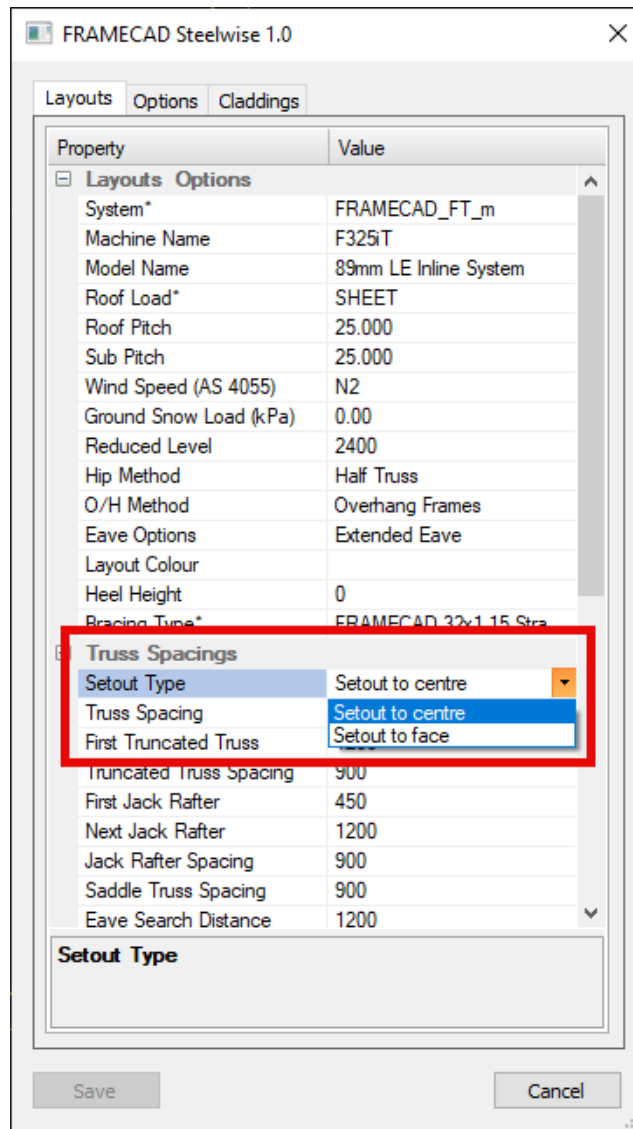

## 7.16 Truss Connections (TC)

New functionality has been added which will allow the user to create a truss connection layout plan. This plan displays the brackets required for truss to top plate connections and truss to truss connections.

### 7.16.1 Commands

Menu Group	STEELWISE_GROUP
Global Name	_TRUSSCONNECTIONS
Local Name	TRUSSCONNECTIONS
Alias	TC

### 7.16.2 Available Options

Options for this command are located in 'TSET' => 'Options' => 'Connections Option':

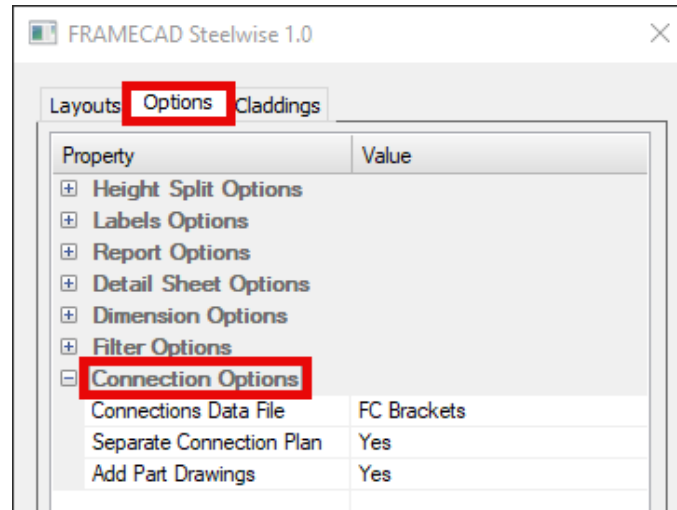

#### Connection Data File

Here you select the data file you want to use that contains the connection data. This is a point in time setting, meaning that if you create a bracket plan after changing this setting then previous bracket plans will remain unchanged.

#### Separate Connection Plan

If value is set to 'Yes' the bracket plan will be placed on a separate border prompting the user to select a point within the border. Anything within the selected borders will be deleted. Gridlines and reference points are also copied.

If value is set to 'No' the bracket plan will be placed on top of the roof truss layout, if the bracket plan already exists in the truss layout, it will be deleted and redone not affecting the truss layout. Summaries on page will be added in addition to the layout summaries.

#### Add Part Drawing

If value is set to 'Yes', when you create a connection plan you will be prompted for the locations of blocks of all the brackets used when the blocks are available. Please note, this is the blocks of brackets and NOT connection details.

If value is set to 'No', no bracket blocks will be inserted. If the user did not opt to insert the bracket drawings at the command time, he/she can do so later with the 'ID' command.

### 7.16.3 How to Use the command

Running of the command is simple and self-explanatory, just make sure you have a truss layout on the screen before running the command. The command should be run after the trusses have been laid out and built on a detail sheet and after the walls have been laid out and built on a detail sheet. Currently, floor framing has no effect on it. If the user did not opt to insert the bracket drawings at the command time, he can do so later with the 'ID' command.

#### 7.16.4 Listing

There are two methods of listing. You can list the individual symbols on the bracket plan, or you can list the symbol in the top left summary box. Listing individual items will change those individual items only and should update the summary boxes when completed.

Listing a symbol in the top left list box will change all symbols (with the same symbol) on the current plan. When complete, it will update the current plan and cutting lists.

#### 7.16.5 Hyperlinks

Hyperlinks are set to various items on the bracket plans. The text at the top middle of the border has a hyperlink attached to it. This link is set in the data file and is currently set to 'www.framecad.com'. Each bracket block can also have a hyperlink attached to it. Once again that is set in the data file. Currently no blocks have a hyperlink set. To use the hyperlink option, hover over the item, hold your finger on the 'CTRL' key and click on the item. It should then take you directly to the web location. Refer to IntellCAD help for more information.

#### 7.16.6 Colour Coding

Symbols are colour coded and are not customizable by the user.

Colour	Purpose
Green (3)	Used prescriptive method
Red (1)	Reactions or data was not found
Yellow (2)	Calculated OK
Dark Green (106)	Amended by user

#### 7.16.7 Reports

'REP' and 'SUM' commands should pick up the brackets and the relevant fixings. These items are no longer included in the 'TOA' command - existing calculation methods were removed from the 'TOA' command. The 'OR' command should update the on-page summaries.

### 7.17 3D Rotation Around Reference Marker

This function allows the user to work on a job in an orthogonal orientation when it is actually drawn at different angles in the model space by applying rotated REFERENCE MARKERS to the views in the model space.

1. As in the example below, set out the linework in the Model Space as it is to be viewed in 3D.

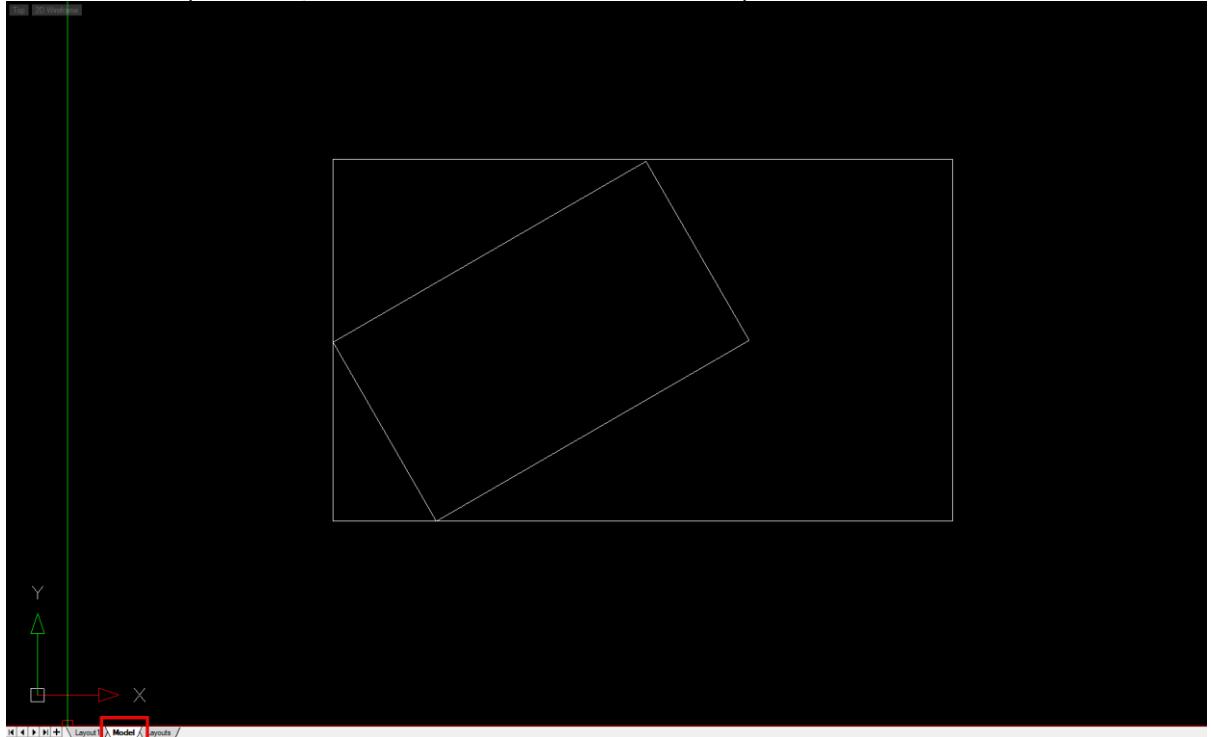

2. Add Primary Reference Markers to each of the building model outlines.

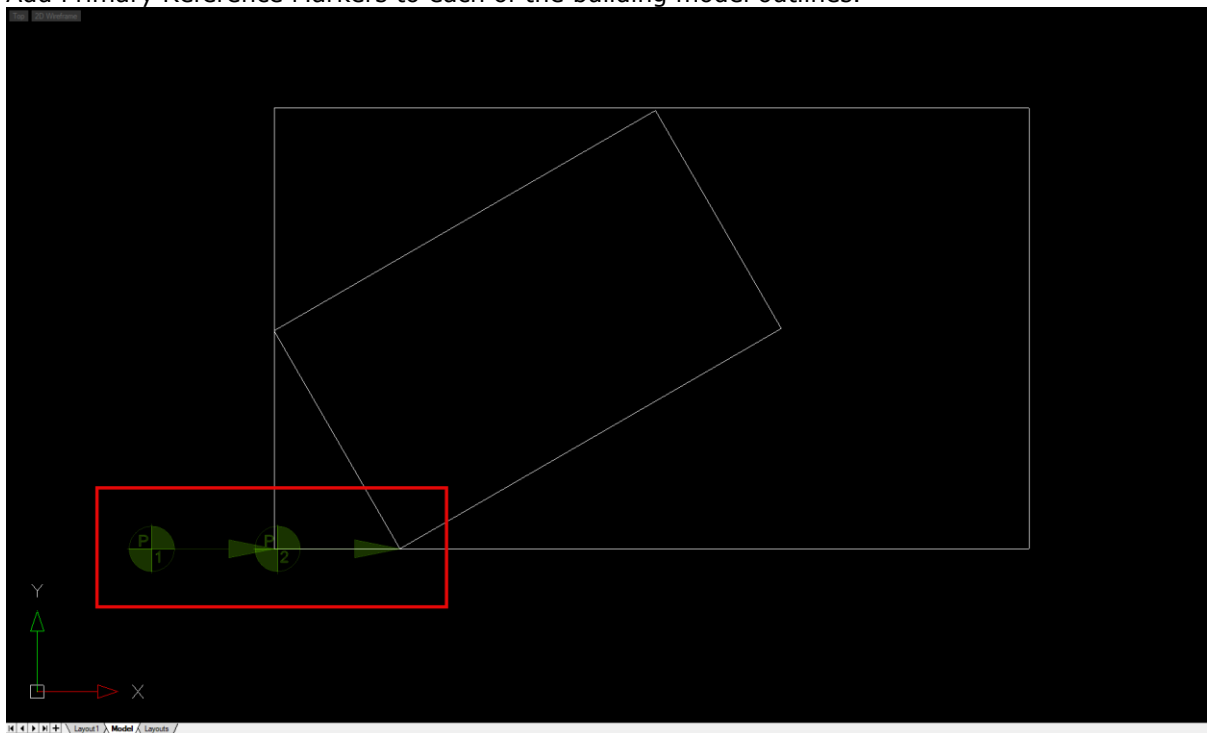

3. Rotate the reference markers to suit the building outline angle.

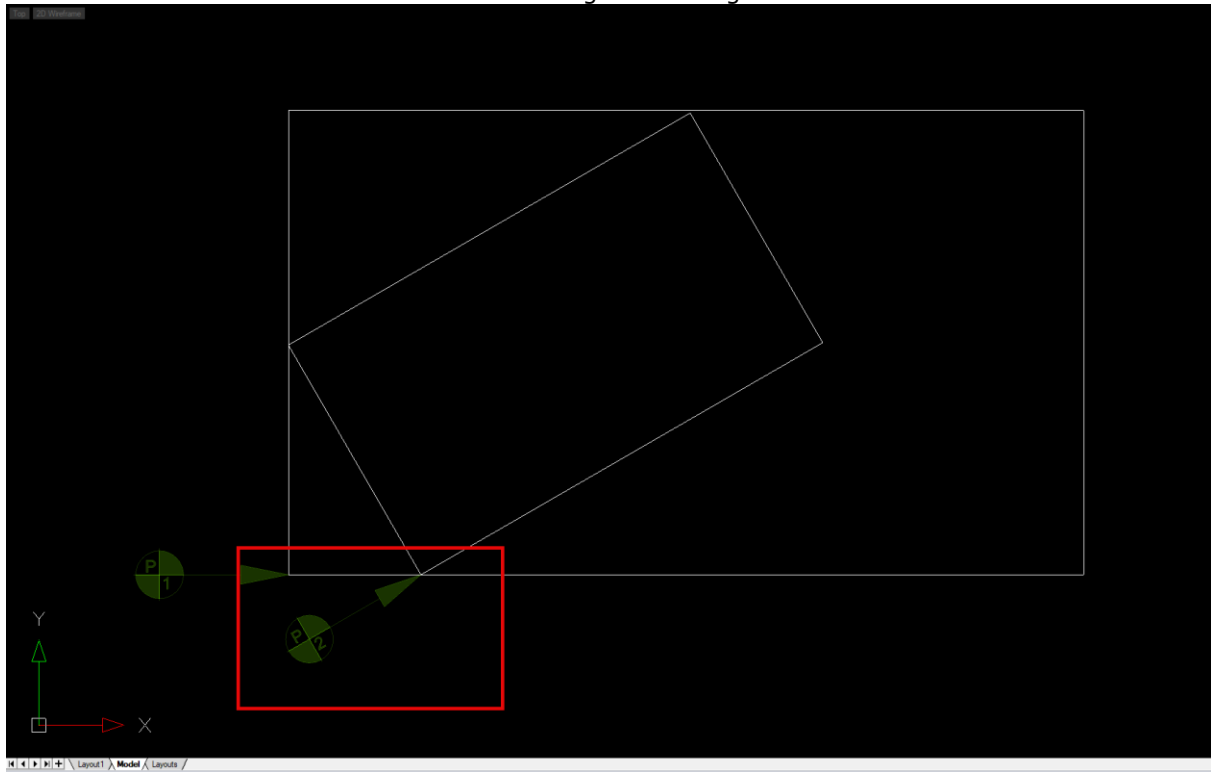

- Copy the outlines to the appropriate Layout Space borders and rotate to suit. Then add the Secondary Reference Markers in the correct locations.

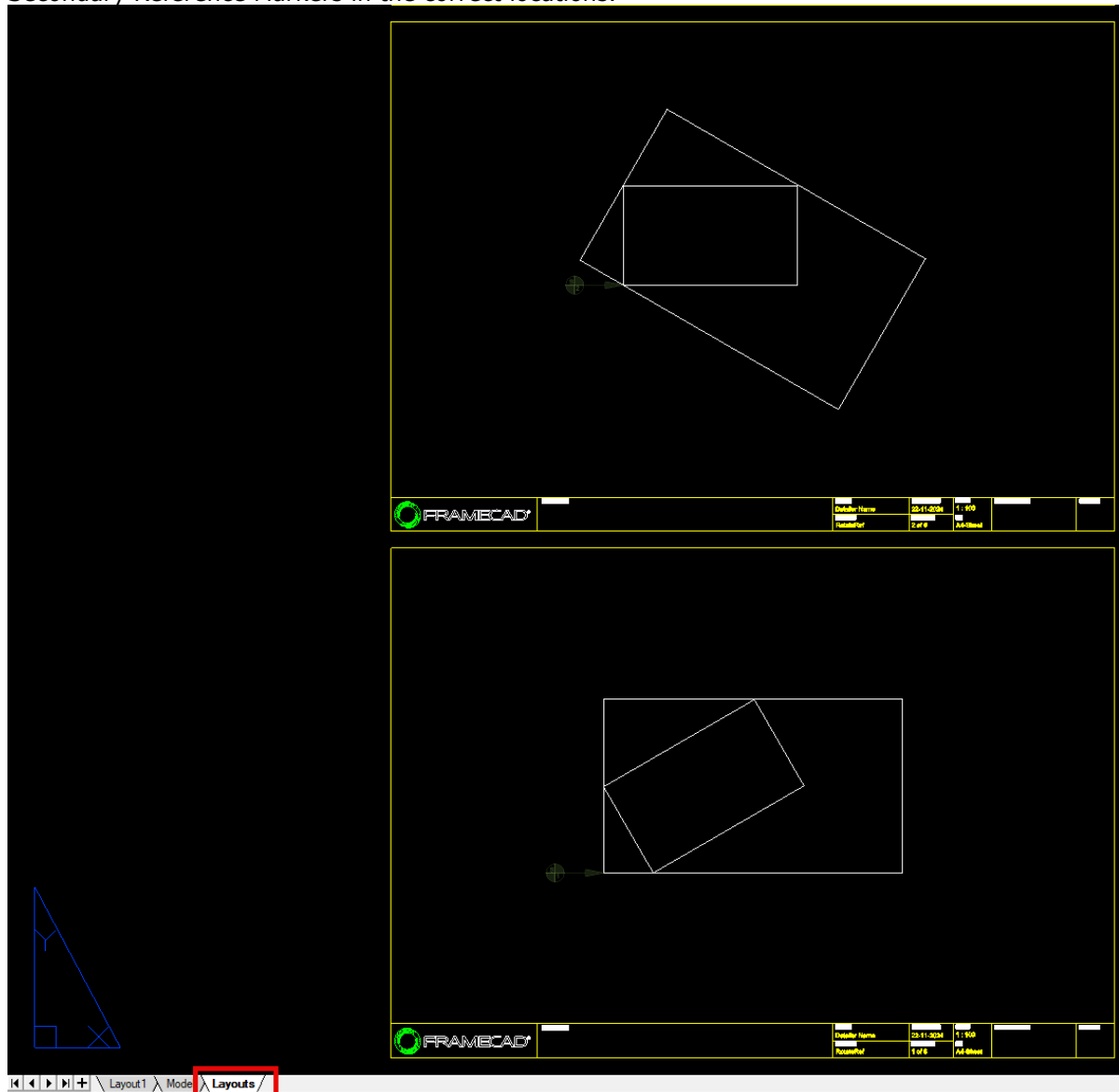

- List and renumber the Secondary Reference Markers to make sure they match the Primary's.

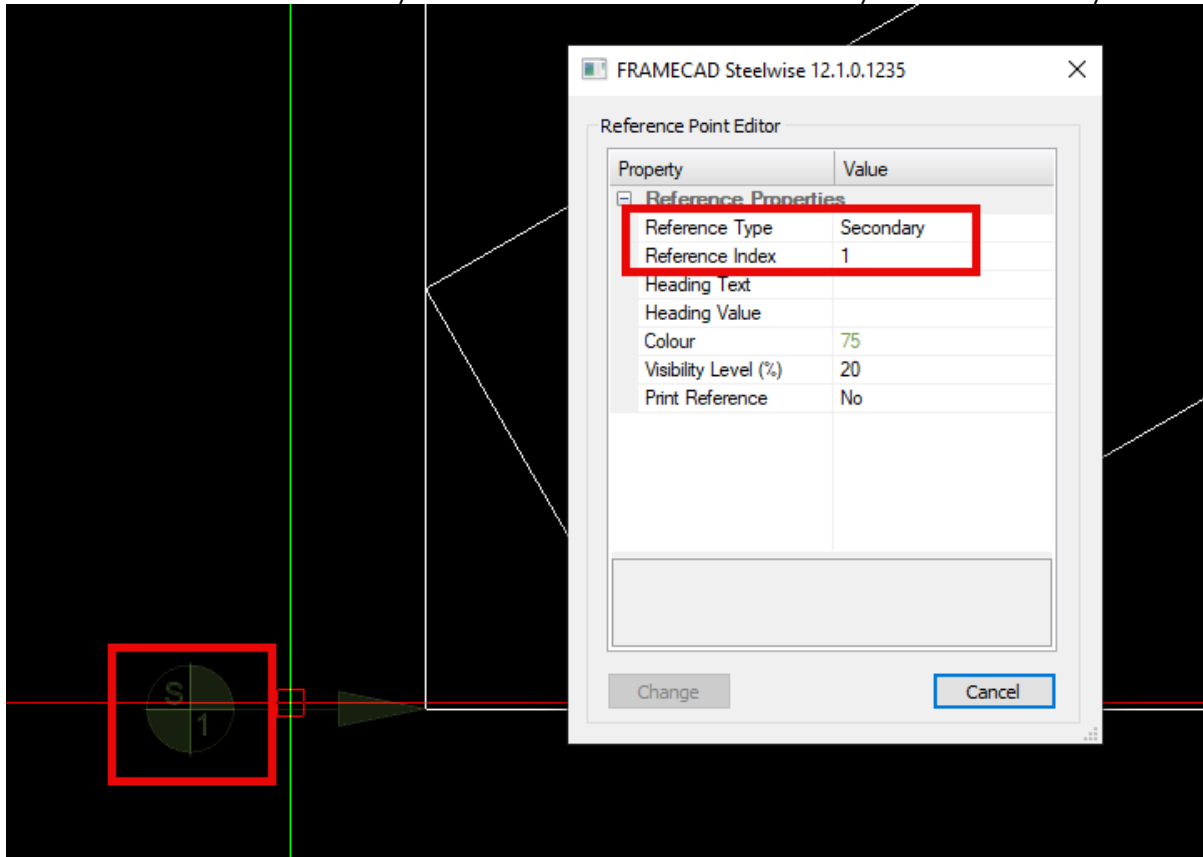

6. Continue detailing as normal.

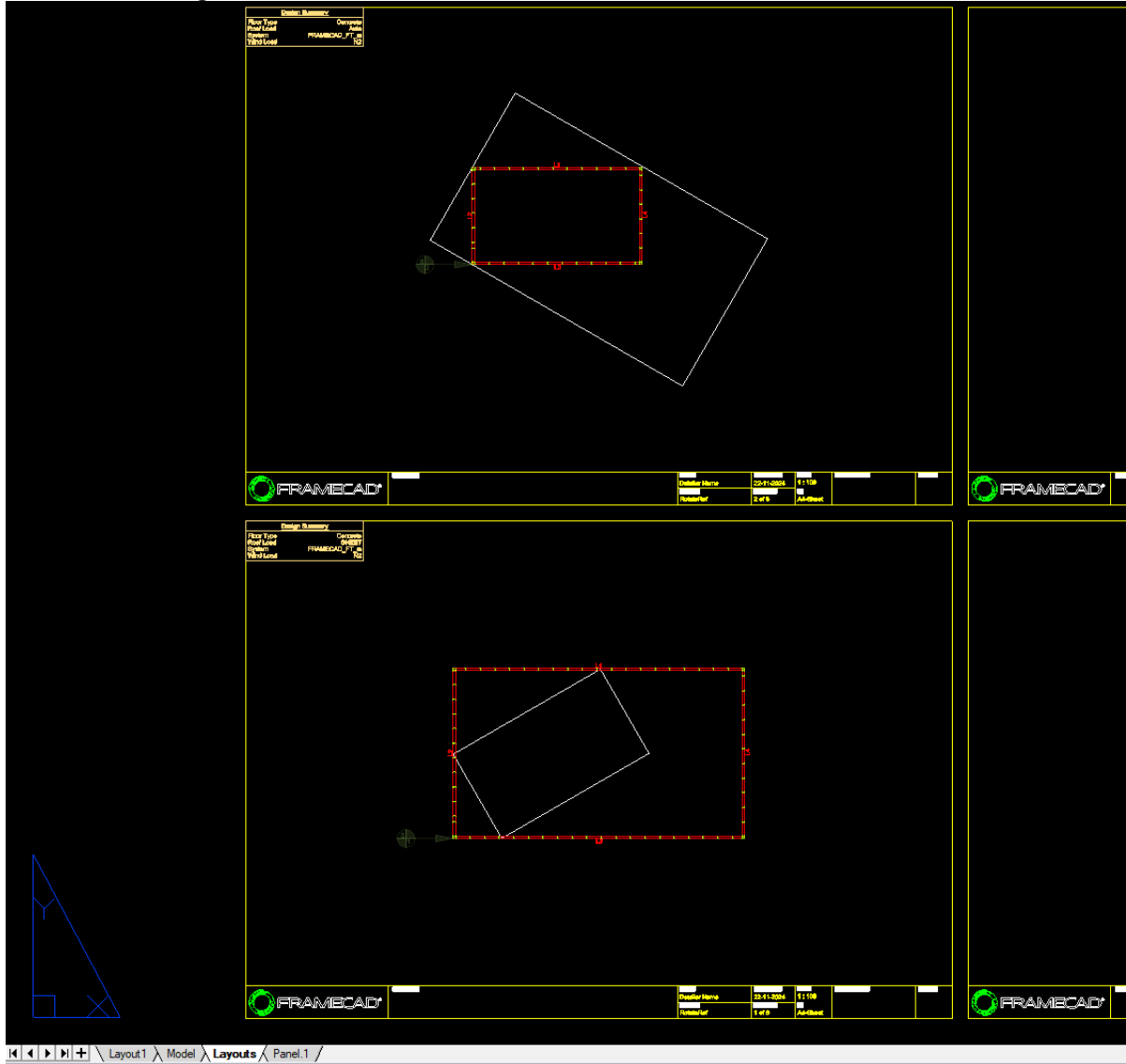

7. Now when you generate the 3D model, everything should appear as you would expect to see.

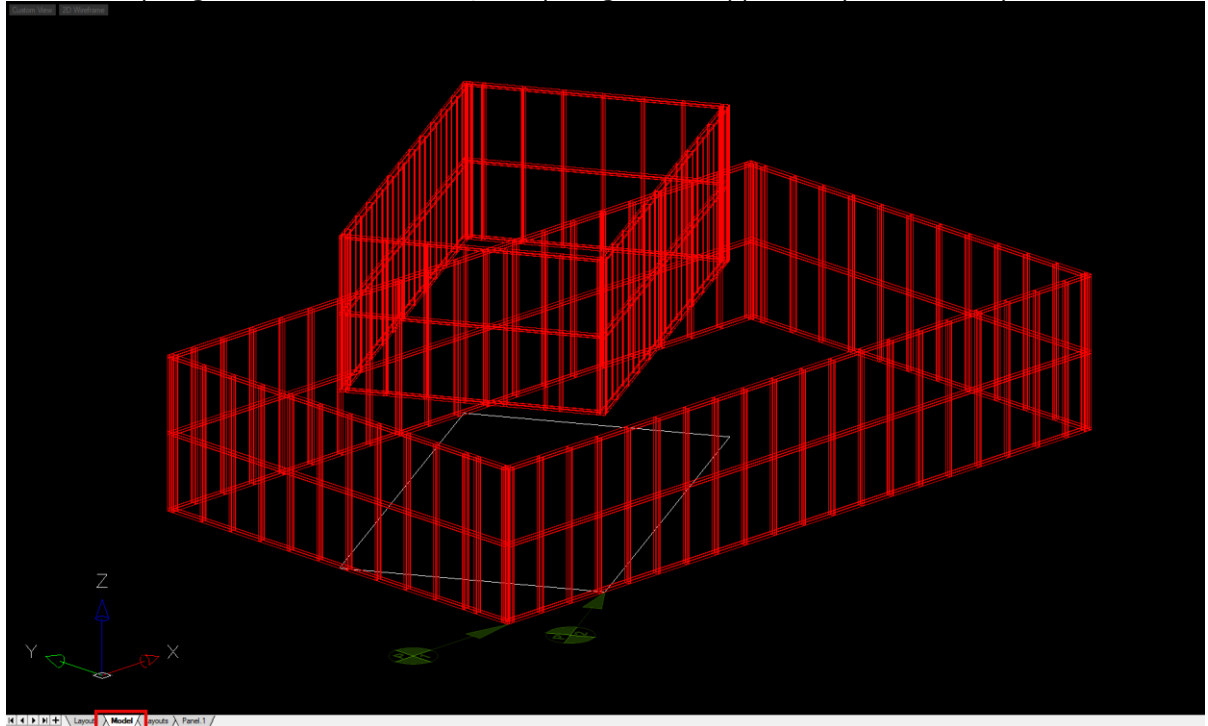

# 8 How To

## 8.1 General

### 8.1.1 RESETALL

Some issues with the software might be able to be rectified by activating the RESETALL command.

This deletes all historical Steelwise information from the computer's registry, thus all user applied settings will revert back to the default settings as if it was a brand-new install on a clean computer.

### 8.1.2 A3D - Frames Not Lining Up

If for some reason your trusses, wall and/or joists are not lining up with each other in the 3D Model Space, firstly check that you have inserted your reference markers (REF) on the layouts prior to building your frames. If you are sure this procedure has been followed correctly, try turning off your 3D by activating the A3D command, then turn the individual layouts by using the J3D, P3D and T3D commands.

### 8.1.3 Checklist

In both the SUM and REP reports, there is now a 'Checklist' tab. This is designed to be printed out for the factory as a manual checklist for the factory for Rolled, Built and Stacked frames.

ID	Rolled	Built	Stacked	ID	Rolled	Built	Stacked
Wall Frames:							
L1 (1)	<input type="checkbox"/>	<input type="checkbox"/>	<input type="checkbox"/>	L10 (1)	<input type="checkbox"/>	<input type="checkbox"/>	<input type="checkbox"/>
L11 (1)	<input type="checkbox"/>	<input type="checkbox"/>	<input type="checkbox"/>	L12 (1)	<input type="checkbox"/>	<input type="checkbox"/>	<input type="checkbox"/>
L13 (1)	<input type="checkbox"/>	<input type="checkbox"/>	<input type="checkbox"/>	L14 (1)	<input type="checkbox"/>	<input type="checkbox"/>	<input type="checkbox"/>
L15 (1)	<input type="checkbox"/>	<input type="checkbox"/>	<input type="checkbox"/>	L16 (1)	<input type="checkbox"/>	<input type="checkbox"/>	<input type="checkbox"/>
L17 (1)	<input type="checkbox"/>	<input type="checkbox"/>	<input type="checkbox"/>	L18 (1)	<input type="checkbox"/>	<input type="checkbox"/>	<input type="checkbox"/>
L19 (1)	<input type="checkbox"/>	<input type="checkbox"/>	<input type="checkbox"/>	L2 (1)	<input type="checkbox"/>	<input type="checkbox"/>	<input type="checkbox"/>
L20 (1)	<input type="checkbox"/>	<input type="checkbox"/>	<input type="checkbox"/>	L21 (1)	<input type="checkbox"/>	<input type="checkbox"/>	<input type="checkbox"/>
L22 (1)	<input type="checkbox"/>	<input type="checkbox"/>	<input type="checkbox"/>	L23 (1)	<input type="checkbox"/>	<input type="checkbox"/>	<input type="checkbox"/>
L24 (1)	<input type="checkbox"/>	<input type="checkbox"/>	<input type="checkbox"/>	L25 (1)	<input type="checkbox"/>	<input type="checkbox"/>	<input type="checkbox"/>

To print the checklist, go to the 'Checklist' tab and click on the 'Print Current' button at the bottom of the dialogue box.

### 8.1.4 Command Aliases (Shortcuts) Missing

If the Steelwise alias commands do not work after loading the software, you can reload them by typing in the DO\_ONCE command.

### 8.1.5 Command Bar Missing

If, for some reason your Command Bar has disappeared, there are a number of options to turn it on again.

1. Click anywhere in a blank area of the Status Bar at the bottom of program display. This option is possibly the most common reason the Command Bar may have disappeared in the first place.
2. Press Ctrl+9 to turn it on or off.
3. Right click anywhere on the Menu Bar and select it from the display options.

4. In the Menu Bar go to View – Display and select it from the display list.
5. In the Ribbon menu go to View – Display and click on Command Bar.

### 8.1.6 Copy

The Copy command uses the standard IntelliCAD COPY command instead of the old Structure MEMBER\_COPY command. This means that when copying multi-faceted members such as trusses, all the components must be selected i.e. overhangs and truss markers. This resolves some of the crashing issues associated with the MEMBER\_COPY command.

### 8.1.7 Creating a Custom Border

By default, the FRAMECAD Steelwise border setup routines use a border called 'BR FRAMECAD'. However, customers have the facility to create a customized border to reflect their company's image.

There is a blank border located in the 'C:\ProgramData\FRAMECAD\FRAMECAD Steelwise\Blocks' directory called 'BR Blank Border.dwg'. To create a custom border, open this drawing in Steelwise and use the 'Save As' command to rename the drawing to the desired name. You must keep the 'BR' with a space after in the name.

In the blank border, a space has been left where you may insert your company logo or any required text. You may alter or rearrange any text within the blank border as you see fit. Lines may be copied, moved or erased as required.

Please do not delete any of the attributes. These attributes are vital to the border's operation. Existing attributes may be moved or rearranged as required. If desired, attributes visibility may be changed from visible to invisible.

When inserting your company's logo, make sure they are in dwg format. Inserting bitmaps seldom work and is generally a waste of time. Also watch the size of the logo used. There is no point creating a custom border if it winds up several megabytes in size. Whilst the border may look pretty the speed penalty taken will certainly overrule the file size.

The FRAMECAD logo can be moved but it must remain present within the border.

Once you have created your custom border you must go to BSET and change the border name to the same as which you have called your filename.

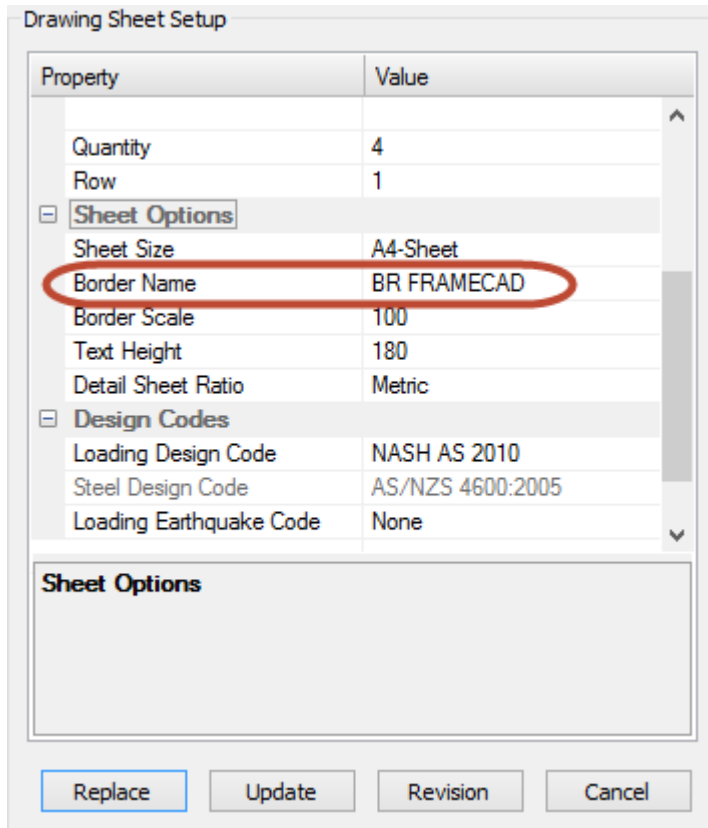

### 8.1.8 Data File Updates

Whenever a data file is updated, any setting changes will only be obvious if you change to another data file then change back again in the settings dialogue boxes. Some changes also require the Model Name to be changed to a different model then changed back again.

### 8.1.9 DET – Detail/Frame Builder

A command called DET has been added which can be used in place of the TTD, PPD and JJD commands. Ensure that the layout you wish to build from is in focus on your screen first and it will build according to Truss, Wall Frame or Floor Layout.

### 8.1.10 ELEVATIONLINE Command Not Recognised

If the **ELEVATIONLINE** command is not recognised, run the **AECOBJECTS** command and ensure it is set to '**ON**'. The program will need to be restarted for any changes to take effect.

### 8.1.11 Export

#### Export As...

Exports job to various file formats such as pdf, svg, bmp, wmf, emf, dwf, stl, dae, dgn.

#### RFY Export

Launches the RFY Export dialogue for RFY Rollformer file creation.

Refer to section

### **PDF Export**

Creates a single pdf file of the selected borders.

### **CNC Export**

Creates an XML file in the C:\Documents\CNC directory from the current detailing space tab.

### **ACNC Export All**

Creates XML files from all detailing space tabs at once.

- Type ACNC
- Separate XML files will be created in the C:\Documents\CNC directory for each existing detailing space tab.

### **VRML Export**

Creates a 3D .wrl file to be viewed in other software (e.g. SAP Enterprise).

- Create a 3D view of the plan in the Model Space by using A3D or T3D/P3D/J3D.
- From the Model Space, use the VRML command.
- A .wrl file will be created in the C:\Documents\CNC directory.

### **IFC Export**

Creates an .ifc file for use in other software (e.g. Tekla, Revit, SAP, etc.)

### **STP Export**

Creates an .stp file for use in other software (e.g. SolidWorks).

#### **8.1.12 File Dialogue Boxes Missing**

'Save As' or 'Open Drawing' dialogue boxes are missing. Some other dialogue boxes are also affected. To rectify this issue, run the FILEDIA command and set to 'ON' by either typing in 'ON' or '1' in the command line.

#### **8.1.13 How to Input Imperial Measurements**

Imperial measurements are generally shown as 8'-6 ½", but must be typed in as 8'6-1/2" when inputting values on the command bar.

You **can't** include a space as the space bar performs the same function as the Enter button or right mouse click.

#### **8.1.14 Importing IFC file into REVIT**

1. If you haven't before, define the IFC Import Options to a setting that matches the type of structures and BIM model you are trying to achieve. To do that, select the "R" button (1) then select the right arrow next to 'Open' (2) and select 'IFC Options' (3) as shown below.

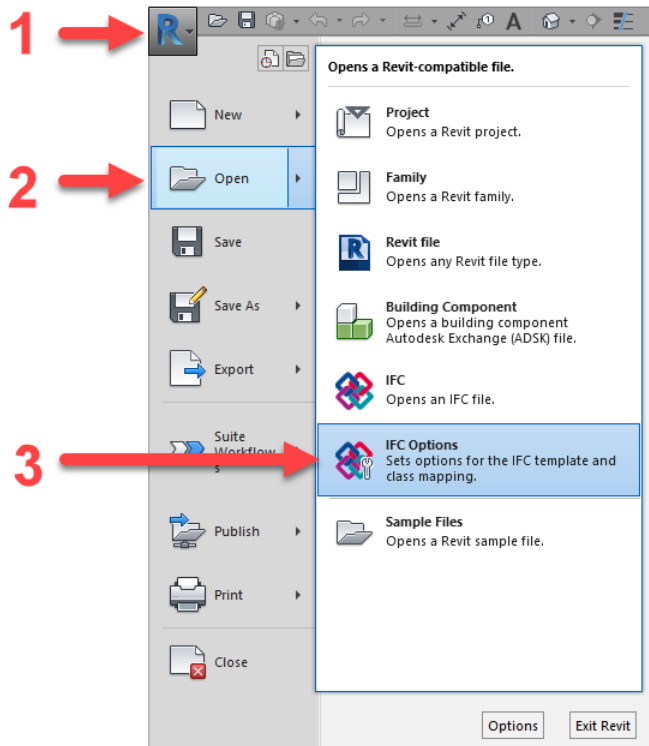

2. In the IFC Options dialogue box, select the template to use for IFC Imports (1) and define the Revit Category to use for each IFC Class / Type (2)

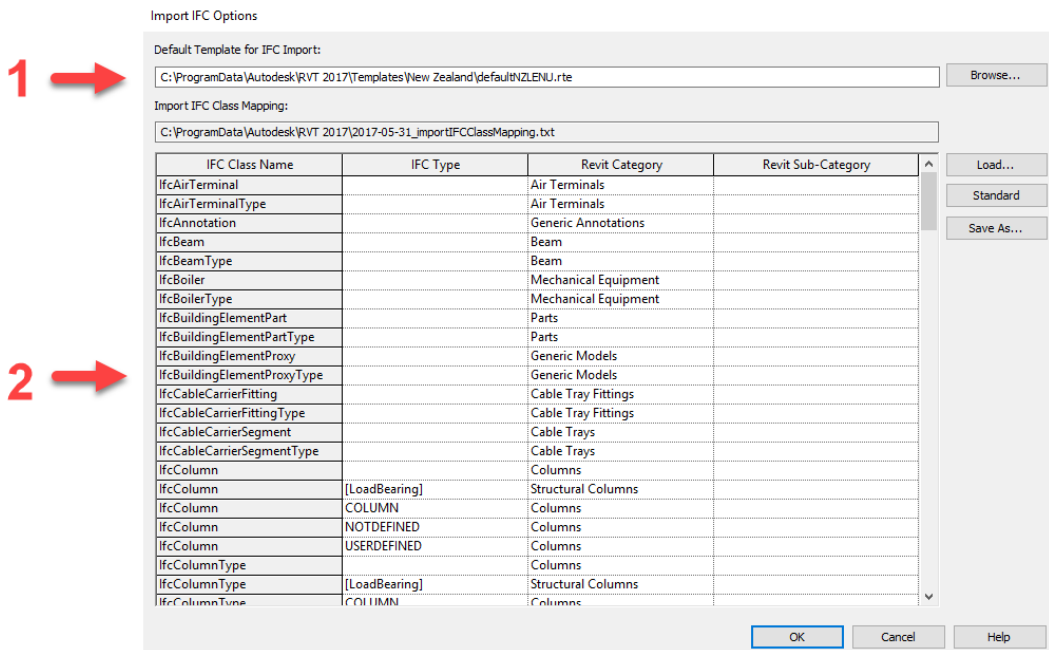

3. Once all your settings are defined, import the IFC file. To do that, select the "R" button (1) then select the right arrow next to 'Open' (2) and select 'IFC' (3) as shown below.

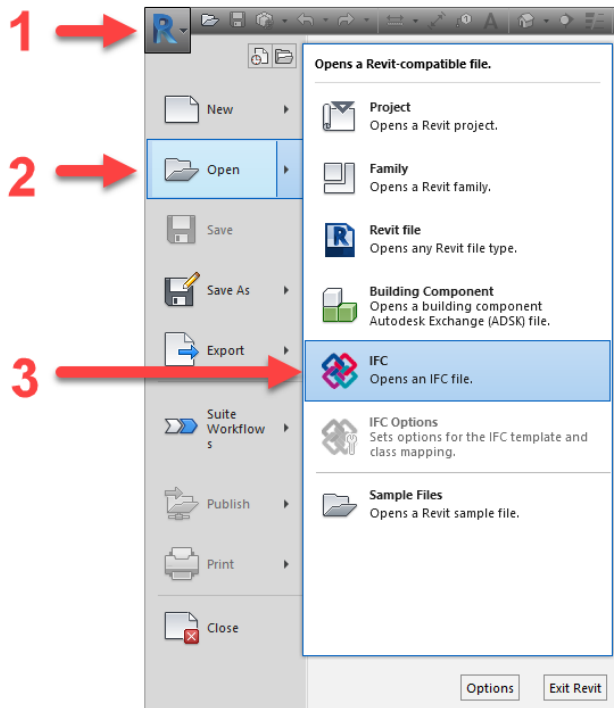

### 8.1.15 Labelling Issue

Wall, beam, truss and joist labels must never start with an 'X' as X is the default value used for unlabelled frames.

### 8.1.16 Menus – How to Resolve Missing Menus

If the Steelwise menu is missing from the menu bar when loading the software, you can reload it by activating the DO\_ONCE command.

### 8.1.17 Mirroring Jobs

This is a general guide only – some trial and error may be required to ensure that you get the correct desired outcome.

Wall Frame Layout

- Mirror the wall layout
- Turn off (LF) or delete (LE) the studs.
- Run the Panel\_Reverse (RF) command on any walls that you want to view from the opposite side.
- PUA the walls to update the studs. Run LS to show the studs if you ran the LF command in step 2.
- Re-PPD the walls.
- Re-P3D the walls.

The above steps will also depend on the complexity of the job and how much editing has initially been done.

Truss Layout – LE Inline Truss System

- Mirror the truss layout

- No other steps are required

Truss Layout – LC Back-to-Back Truss System

- Mirror the truss layout
- Re-TTD the trusses

Floor Joist Layout

- Mirror the floor layout
- No other steps required

#### **8.1.18 Move**

The Move command uses the standard IntelliCAD MOVE command instead of the old Structure MEMBER\_MOVE command. This means that when moving multi-faceted members such as trusses, all the components must be selected i.e. overhangs and truss markers. This resolves some of the crashing issues associated with the MEMBER\_MOVE command.

#### **8.1.19 PCB (Calculate Wind) Not Working**

Ensure you have reference markers (REF) on your plans.

#### **8.1.20 PDF (PDFEXPORT) Bad Fonts**

The fonts on pdf exports appear as hieroglyphics rather than proper text. This is due to the fact that fonts are not embedded into the pdf. As a result, the device that you try to view the pdf on may not have the matching fonts installed in it. This is a bigger issue with Apple devices as Apple choose not to conform with anyone else.

In the PDF dialogue box there is an option to tick on 'Embed TTF Fonts' and 'Convert TTF fonts to graphics'. Tick the first option to see if this resolves the issue. Failing that, try the second option as well. The only downside is that the file size of the pdf will increase.

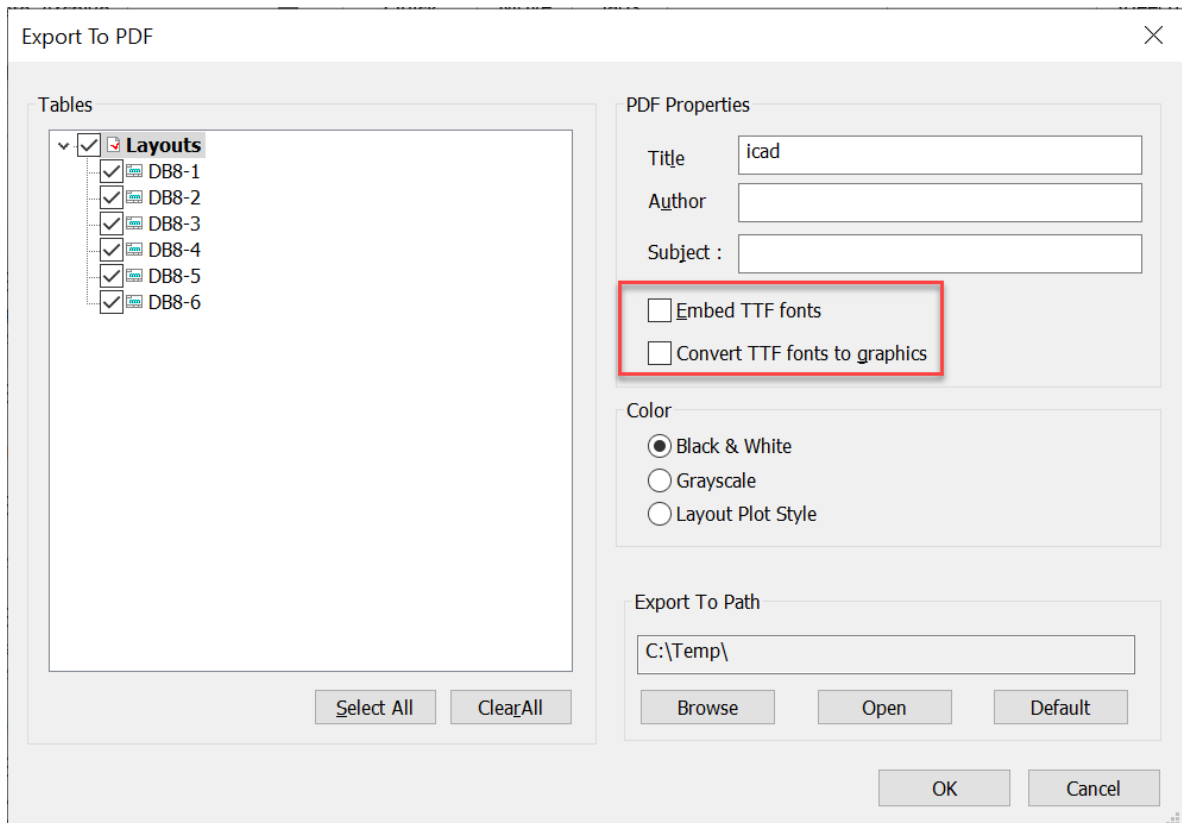

### 8.1.21 PDF (PDFEXPORT) Not Working

In version 8.1.100.9 and later, the border logo had been updated which may cause issues with the PDF command for some users with custom borders. This also depends on how the custom border has been created. In these cases, you will need to send the file through to FRAMECAD to be edited.

The use of 'Splines' within custom border logos or any imported details will also cause issues with the PDF functionality. Splines must be converted to polylines.

### 8.1.22 REF – Multiple Reference Marker Placement

To add reference markers to every border in the same location, hold the 'Alt' key down while placing the Primary marker.

### 8.1.23 Reactors

Various reactors have been added to the software which automatically perform tasks in the background that previously had to be undertaken manually by the user.

Below is a list of some of these reactors and what they do:

**Borders** – If a border is deleted, the view names are updated to reflect the new quantity and sequence.

**Editor** – In Detailing Space, the cutting lists in each border are updated whenever a command is ended.

**Reference** – Deleting a reference point marks the drawing as being out of date. The PUA function is automatically activated.

Stud – The stud locking prompt is activated whenever a stud is copied, moved, mirrored, etc.

Tab – Renaming a tab automatically renames the borders within the tab.

Truss – Using the standard CAD erase tool on a truss also removes all entities associated with that truss (i.e. works the same as the SE command). Changing the length of a truss (longer or shorter) by stretching increases or decreases the span.

Truss Support – Deleting a support from a truss in detailing space automatically fails the truss. The truss needs to be re-engineered.

Wall – Using any editing command on a wall looks at all associated parameters of the wall and adjusts them accordingly, e.g. if a sloped wall is shortened using the MT, ME or MF commands, the height at that end of the wall will automatically adjust to suit.

Wall Detail – Erasing members in a wall frame also deletes the associated entities (screws, labels, etc).

#### 8.1.24 Resolve Graphics Performance Issue

Sometimes the graphic performance of the program becomes erratic. A known cause of this is having too many entity snap options selected. When initially selecting entity snaps, it always pays to only select those which you will commonly use. Here is a recommended list of options.

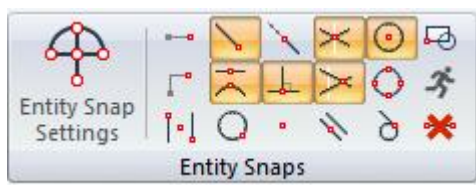

Note that these options will automatically change during the detailing process depending on the command that is initiated.

#### 8.1.25 Restoring an 'AutoSave' Drawing

To restore an 'AutoSave' drawing:

- Go to Tools – Options on the menu, go to the Paths/Files tab, expand the 'Auto backup' section, right click on the directory location displayed and select 'Open Containing Folder'.

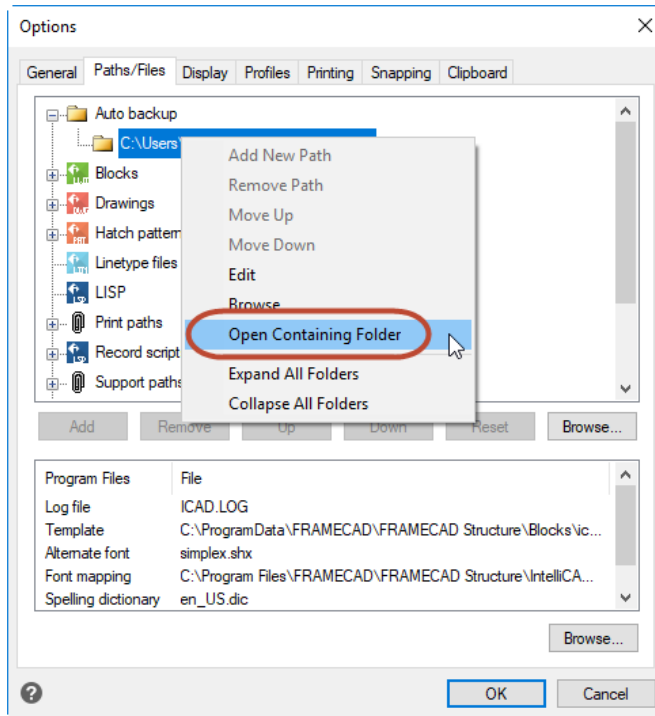

- Find the file of the appropriate name. Sort the files in order of 'Type' if this makes searching easier. You will be looking for files under the 'SV\$ File' type.
- Copy the file to the directory where you would normally keep your job files.
- Change the files extension name from '.SV\$' to '.dwg'.
- Open the file as normal in Steelwise.

### 8.1.26 Open and Save As... Dialogue Boxes Gone

The user is not able to use a dialog box to select files for opening or saving. In these cases, rather than seeing the dialog box, they are prompted to manually enter the full file path and name of the drawing or file they want to open at the command line.

In most cases, we've noticed that the system variable tends to reset when a file crashes during closing, or when the application runs into an error during shut down or saving. When that happens, **FILEDIA** changes back to "0," and the next time you try to open a file, you're prompted to enter a file name and path rather than select.

To fix the problem, either launch a new drawing, or double click on an existing drawing to get to the command line and type in **FILEDIA** to set it back to "1."

### 8.1.27 Scroll Between 3D Views

Use VV to scroll between various 3D views.

### 8.1.28 SECTION MARK

Cross section markers can be added to a drawing using the **SECTION\_MARK** command.

### 8.1.29 SECTIONLINE Command Not Recognised

If the **SECTIONLINE** command is not recognised, run the **AECOBJECTS** command and ensure it is set to **'ON'**. The program will need to be restarted for any changes to take effect.

### 8.1.30 SHOW – Engineering Failures

To show engineering failures press return while in the command.

### 8.1.31 STRIP – Strip Entity Property Intelligence

Strips any of Steelwise's entities of all property intelligence.

This is useful when copying walls or beams to another layout for set out purposes, e.g. using walls or beams on a joist layout for better clarity when inputting joists. If these members are left as they are, you end up with a double up of members in the job. You must not combine walls, trusses and joists on the same layout plan as it will cause issues with labelling, frame building and reporting.

Exploding entities does not remove the data. If you explode them, you end up with a series of individual lines that still contain entity data. Stripping the data from these entities also leaves them as complete polylines.

### 8.1.32 SUM – Report Summary

Provides a material summary report for all the individual tabs and a total job summary.

### 8.1.33 -TTD – Truss Builder (Silent)

This command allows the user to re-engineer a given truss from within the elevation view (detailing space).

What this means is that when modifications are made to a truss in elevation view (detailing space), the user can then re-engineer the truss without bringing up the Truss Builder dialogue box, which can result in the truss reverting back to its original state prior to any modifications when clicking on the Update button.

It also allows you to build trusses from the layout while by-passing the Truss Builder dialogue box.

### 8.1.34 Importing a Job Created in FRAMECAD Structure

When opening a job that was started or completed in the FRAMECAD Structure software, a dialogue box will open asking if you wish to 'Upgrade' the job to be able to be completed/edited in Steelwise, or whether you just wish to 'Open as Regular DWG' which can be reviewed but unable to be worked on.

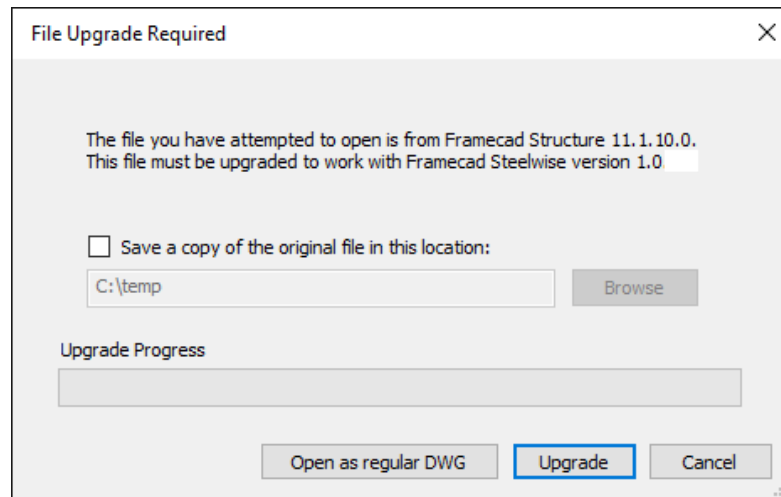

If 'Upgrade' is successful, then another dialogue will pop-up allowing the user to map the current system used within the job file to any other system which may be present in the user's system Library directory.

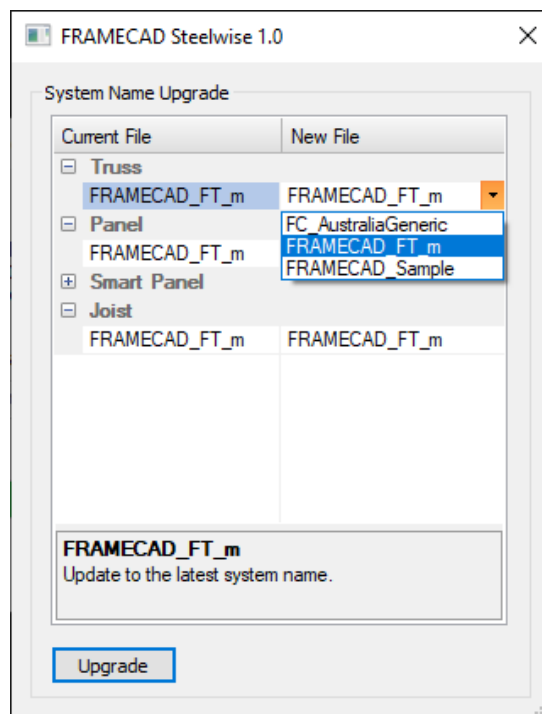

If 'Upgrade' is selected and a system name within the job doesn't exist in the users Library directory, then another dialogue will pop-up indicating that missing system name.

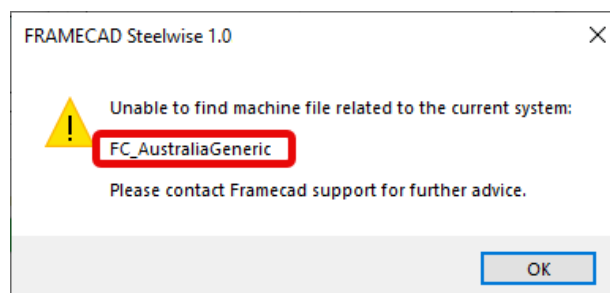

The user will then need to either contact FRAMECAD support to create/provide the necessary data files for that job or they can re-open the file as a regular DWG file for viewing purposes only.

If '**Open as Regular DWG**' is selected, all Steelwise functionality will be disabled for that job except for the following:

PDFSPOOL (PDF)  
SPOOL\_PRINT (SP)  
FIND\_ITEM (FF)  
VERSION (VER)  
ALL View commands outside of 3D  
ALL Dimensioning Commands

If '**Upgrade**' is successful, then running the LA command in each detail sheet tab will update the title box information and re-associate any lost association links with the layouts.

### **8.1.35 Using Viewports (Standard IntelliCAD usage not directly related to Steelwise usage)**

The maximum number of viewports that can be opened in one tab is 64, which is the same limitation as AutoCAD. However, there is also a 'SETVAR' called 'MAXACTVP' which also limits the number of viewports (value must be between 2 and 64). By default, the 'MAXACTVP' is set to 48. To increase its quantity to the maximum, just type 'MAXACTVP' in the command line and increase the quantity as required. Should more viewports be required, I would suggest that the user starts off a new tab, as there is no way around the 64 limitation.

### **8.1.36 VM – Make View**

In addition to being able to make new views in Detailing Space, use the following steps to update a wall, joist or truss frame in the detailing space.

This assumes that the wall, joist or truss frames have already been built and you need to rebuild one or more frames but don't want to re-export all the frames again. The reason for this could be because too much editing has already been carried out on a number of existing frames.

- Re-export the required frame(s) to a new tab.
- Delete the old frame from the border in the initial tab.
- Copy the new frame into its place.
- Type VM then press Enter.
- Enter the number of the border view.
- Select the view area by selecting the opposite corners of the border.
- Delete the new tab.

### **8.1.37 X – Previous Zoom**

Enter 'X' to go to the previous zoom.

### **8.1.38 Zone Grouping for Walls and Joists**

When Listing (LI) walls or joists, the listing dialogue box shows an option in General Information called 'Zone Location'. This allows a selection of entities (walls or joists) to be grouped into areas.

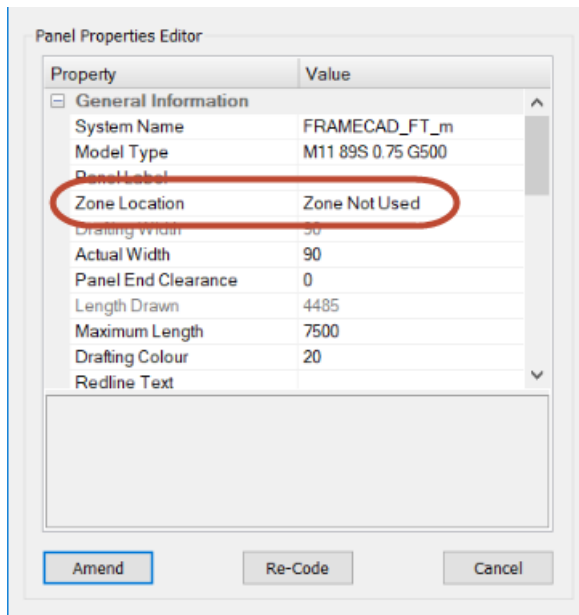

To use this, select and list (LI) a group of walls or joists, then in the Zone Location, overwrite 'Zone Not Used' with a label that best describes the location of the selected frames, e.g. Unit1. Select the next set of frames and type in Unit2. When you perform a PPD or JJD, these frames can then be filtered by zone when building. The zone label will be shown in front of the panel or joist label in the elevation views.

In PSET – Options – Labelling Option Information, you can set 'Restart Zone Numbering' to 'False' to have continuous numbering through all zones, i.e. all numbers will only be used once and not repeated.

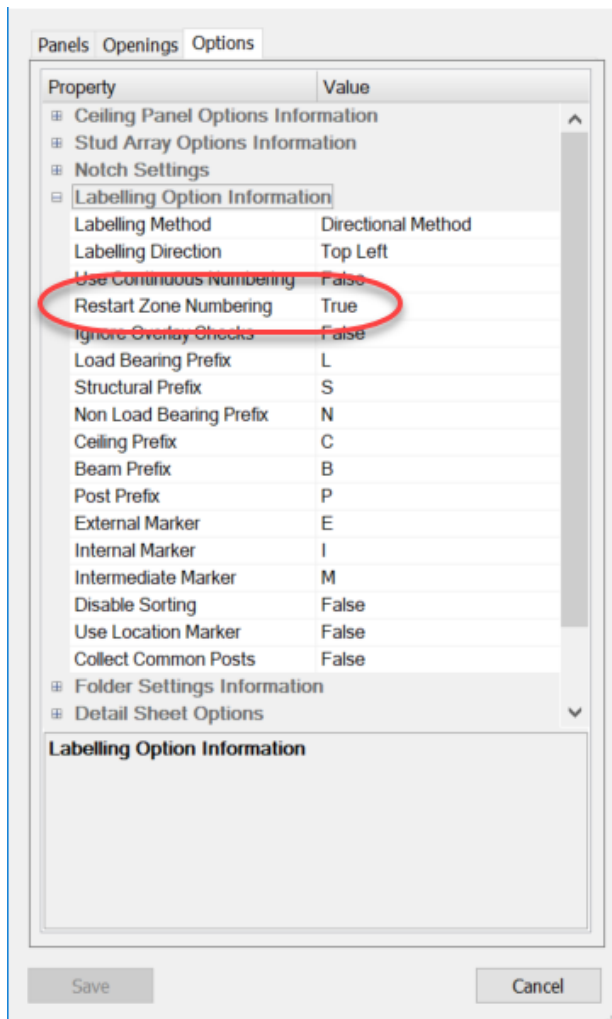

**Note:** Do not start the zone location description with 'Z' or 'X'. Description length is limited to 6 characters and spaces will be eliminated.

This option is ideal for large commercial or multi-unit buildings.

### 8.1.39 ZZ – Toggle Tabs

Switches between current tab and last active tab in a job.

## 8.2 Floor Detailing

### 8.2.1 Add or Amend Floor Beams

- Make sure you have the correct System Name selected in the PSET settings.
- Activate the ADD command and go to the Joist tab
- Ensure you have the correct System Name selected
- Hold the ALT key down and left mouse click on 'Member\*'. This will open a Floor Beam Editor dialogue box. Please contact your system administrator if access is denied.

- Add or amend floor beams as required.
- Click on Add/Amend.

Adding or amending floor beams will create a new user data file in the C:\ProgramData\FRAMECAD\FRAMECAD Steelwise\Library directory with the same name as the System Name selected but with 'USER' at the end of the name. Any information within this data file will take precedence over the parent data file.

## **8.2.2 Adjusting Floor Joist Web Spacing**

### **Floor Member Editor - Web Spacing**

When changing the depth of a joist, the user must List (LI) the joists and change the web spacing under Material Information. This should be changed to be equivalent to the joist depth to achieve an approximate web angle of 45°. The default web spacing is set to 300mm.

## **8.2.3 Automatically Hide Layout Layers on PPD (PSET – Options)**

Detail Sheet Options:

'Hide After to CAD' gives the option to hide (or leave unhidden) the following layers: Opening Label, Panel Brace, Panel Opening, Panel Stud. Leaving these layers hidden allows for an uncluttered plan for easier viewing on site by the framing erector.

## **8.2.4 Deep C Floor Joists – Creating RFY File**

When detailing a deep C floor layout in Steelwise, you must create the RFY file from within the layout space. You don't need to build (JJD) the deep C joists as there is nothing to build. The only reason you may wish the JJD them is to get engineering results.

## **8.2.5 Detail Sheet Border Size**

'Border Sized to Fit' option added which makes all the floor joist elevation borders the same size if preferred. The 'Detail Sheet Options' can be found on the 'Others' tab in JSET.

## **8.2.6 Floor Member Summary – No Ceiling Batten Material Displayed**

If you require ceiling batten material to show in the Floor Member Summary, you must make sure that you have set the Ceiling Batten Spacing value in the Joist Settings (JSET).

## **8.2.7 Move Joist Labels**

To move a joist label in v8.1.8 and later, the user can select the grip on the centre of the label and move it horizontally or vertically. Also, the STRETCH command can be used by dragging a right to left selection box over the label and moving it by base point and displacement point or distance.

Likewise, if a series of labels needs to be moved, use the STRETCH command and select all the required labels.

## **8.2.8 Opening Joist in Detail Space from the Layout**

When listing (LI) a joist on the layout, the option to 'Go to detailed beam' in the Floor Member Editor will open the joist elevation in Detailing Space.

## 8.3 Wall Detailing

### 8.3.1 Add Lintel Plates to a Frame

Lintel plates can be added anywhere within a wall frame in Detailing Space by drawing a line and using the ADD command to code that line as a 'Lintel'.

Note: Lintel plates over openings should only ever be added or changed by listing the opening and making the change in the 'Construction Methods' section of the Opening Editor.

### 8.3.2 Add Lintel Plates to a Webbed Beam

Lintel plates can be added to a webbed beam in 'Construction Methods' in the Beam Editor when listing (LI) the beam.

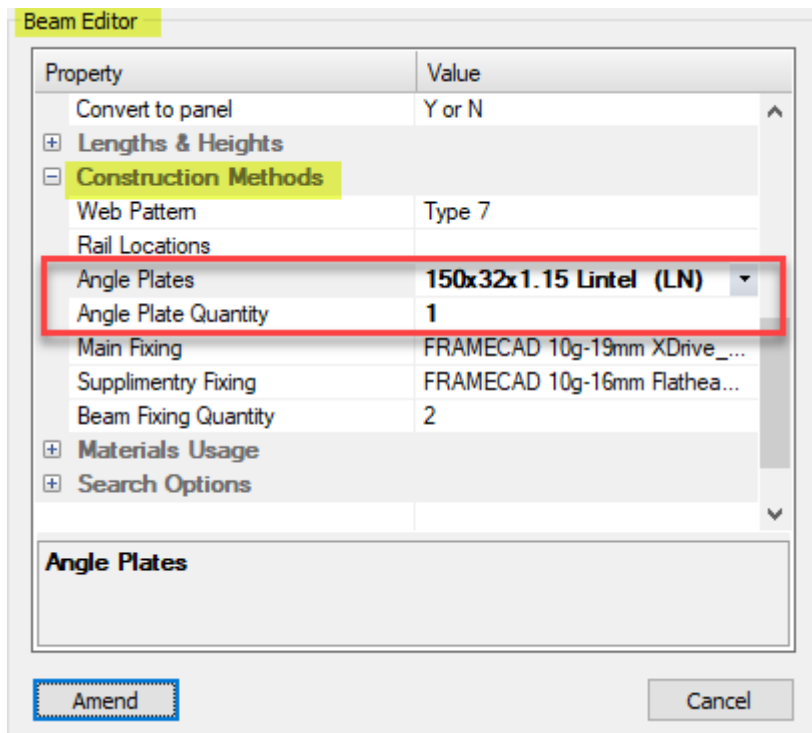

### 8.3.3 Add or Amend Beams in Data File

- Make sure you have the correct System Name selected in the PSET settings.
- Activate the ADD command and go to the Beam tab
- Ensure you have the correct System Name selected
- Hold the ALT key down and left mouse click on 'Beam Name\*'. This will open a Panel Beam Editor dialogue box. Please contact your system administrator if access is denied.

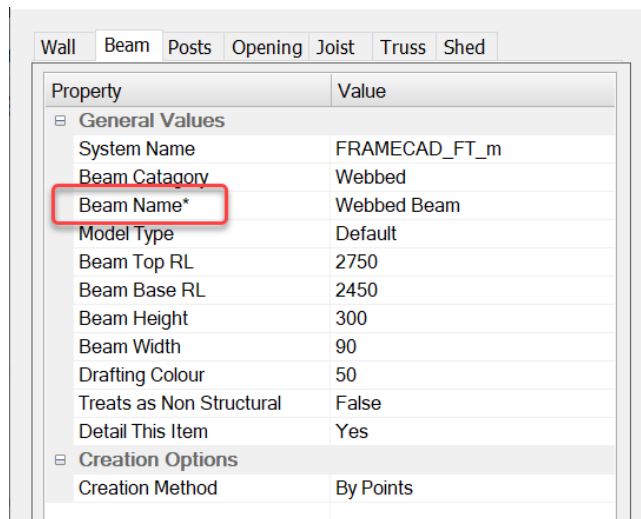

- Add or amend beams as required.
- Click on Add/Amend.

Adding or amending beams will create a new user data file in the C:\ProgramData\FRAMECAD\FRAMECAD Steelwise\Library directory with the same name as the System Name selected but with 'USER' at the end of the name. Any information within this data file will take precedence over the parent data file.

If you are unable to access the Beam Editor, go to your Licence Manager (VER) and see if Sub Edit Feature 2005 is Enabled.

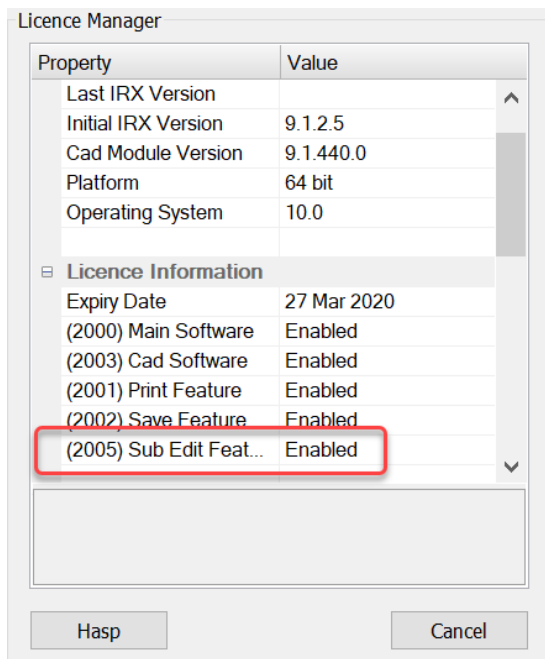

If it is Disabled, you can request it through MyFramecad Care - <https://my.framecad.com/FCADCare>.

### 8.3.4 ADD – Beam Heights

The level to the underside of beams is displayed in the **ADD – Beam** dialogue box and the **Panel Coding Editor** when changing a wall to a beam. Changing this value will not alter the Top Level, it will only change the beam height value.

Property	Value
<input type="checkbox"/> <b>General Values</b>	
System Name	FRAMECAD_FT_m
Beam Name*	Webbed Beam
Model Type	Default
Beam Top Level+	2930
<b>Beam Base Level+</b>	<b>2630</b>
Beam Height+	300
Beam Width+	90
Beam Type	Webbed
Drafting Colour	1
<input type="checkbox"/> <b>Creation Options</b>	
Creation Method	By Points

### 8.3.5 Changing the Panel Properties of a Detailed Wall

You need to change the material, height, nog location, etc. (i.e. most of the parameters that are greyed out when listing a wall panel from the Panel Builder).

- List the wall in the framing layout
- Make the necessary changes
- Run the PUA command in the layout
- Go to the wall panel in the detail sheet
- PPD the wall
- List the wall in the Panel Builder by double clicking on the wall label in the left-hand column
- Click on the 'Amend' in the Panel Properties Editor
- Click on 'Update' at the bottom left of the Panel Builder

### 8.3.6 Check Load Path onto Walls

The Load Path (LP) command provides a centre line overlay of the trusses or floor joists over wall frames. To use this command:

- Centralise the wall framing layout on your screen.
- Type LP and Enter. The view will zoom out to display all the borders.
- Click within the border that contains the trusses or floor joists.
- The view will zoom back into the initial layout with the truss or joist centrelines overlaid.

- If these lines are yellow, then this indicates that all the loads are being transferred correctly.
- If the lines are red, this indicates that no loads are transferred.
- Type LP again to turn the lines off.

Note: If walls are set as “Structural”, then the truss or joist lines will show as being red. The loads are still being transferred but only as evenly distributed loads, not as concentrated loads.

### 8.3.7 Defined Door Input

For users that prefer to use the ‘Defined Door Input’ options as shown in the Design - Panels/Walls – Layout menu, not all the available options are listed here. Any other required options must be accessed from the ‘Opening’ tab in the ADD command. Double click to select the required option.

### 8.3.8 Detail Sheet Border Size

‘Border Sized to Fit’ option added which makes all the wall elevation borders the same size if preferred. The ‘Detail Sheet Options’ can be found on the ‘Misc’ tab in PSET.

### 8.3.9 How to Erase Lintel L Plates and Leave Member Screws

If you delete a lintel L Plate from an opening using the **SE** command, all the screws on the members underneath the plate will also be removed. To stop this from occurring, use the **E** erase command instead.

### 8.3.10 Inserting Webs into Wall Frames (IW)

- If a member is inserted vertically (or within 5° of vertical), it will snap into place as a vertical stud member.
- If a member is inserted horizontally (or within 5° of horizontal), it will snap into place as a horizontal web member.
- If a member is inserted diagonally from one existing member intersection and then to another existing member intersection, the member will snap to the selected member at a predetermined dimple to dimple distance. Note: this only works if there are fasteners present on the existing members.

### 8.3.11 MB vs MC on Raking Walls

Do not use the MB (MEMBER\_BREAK) command on raking walls. Only the MC (MEMBER\_CUT) command will work properly to maintain the correct heights.

### 8.3.12 Opening Commands

The following commands are used in conjunction with the parameters set in the PSET – Windows options. When a door leaf size is entered into the relevant command, the set clearances are added to create the correct trim opening size in the wall frame.

Alias	PSET Category
AR Archway Opening (or Square Set Opening)	Nibbed Robe Information
CS Cavity Slider (Pocket Slider)	Cavity Sliding Door Information
ED External Door	External Hung Door Information

FS	Face Slider or Surface Slider	Face of Wall Sliding Door Information
R1	Robe Door (Single Door)	Hinged Robe Door Information
R2	Robe Door (Double Bi-fold Door)	Hinged Robe Door Information
R3	Robe Door (Triple Bi-fold Door)	Hinged Robe Door Information
PA	Passage Door (Standard Internal Door)	Internal Hung Door Information
S2	Internal Slider x2	Sliding Robe Door Information
S3	Internal Slider x3	Sliding Robe Door Information
S4	Internal Slider x4	Sliding Robe Door Information

### 8.3.13 Opening Input by Point

All opening inputs have a 'P' option for placement. This allows the user to select a point which centrally locates the opening on that point.

### 8.3.14 Openings – Label Options

Label Location – allows the door/window type label to be placed either before the door window size (Pre Fixed) or after the size (Post Fixed). E.g. Pd760 or 760Pd. There is also an option to either leave a space between the label and the size or omit it.

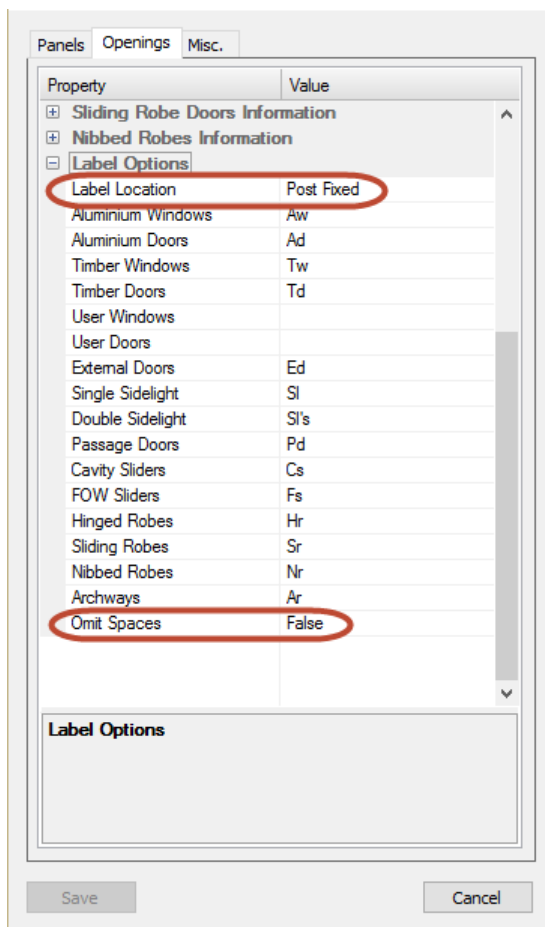

### 8.3.15 PCB – Panel Calculate Brace

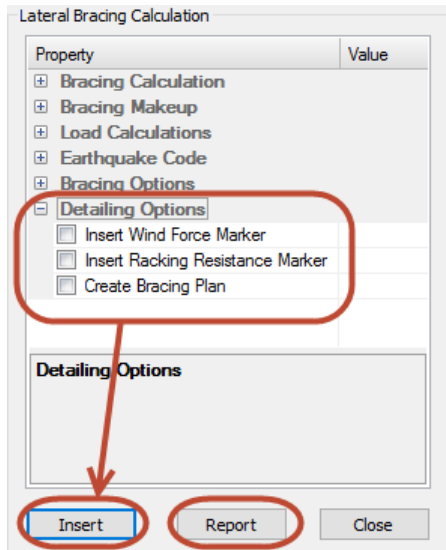

A bracing report can be generated with all the values for the Current Layout and values for each individual wall. The brace report option has been removed from its previous location in the Detailing Options and given its own button at the bottom of the dialogue box.

The Insert option is used to input one of the options selected in Detailing Options or, if nothing is selected, will allow the user to input braces. PIB is also used to input braces without having to activate the Bracing Calculator.

### 8.3.16 Panel Labelling Options (PSET – Options – Labelling Option)

Labelling Method:

- Traditional Method (old) - Labels all walls from the top left-hand corner of the framing layout in a diagonal direction towards the bottom right.
- Directional Method (new) - Labels the external walls anti-clockwise from the corner of the layout as indicated by the 'Labelling Direction' (walls may be labelled in a clockwise direction if the start walls are lapped differently). Internal walls are then labelled from the same corner then towards the opposite corner of the layout.

### 8.3.17 Post Input Error Message

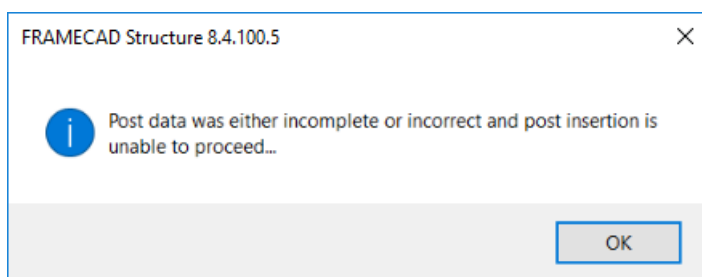

The above message will appear under the following circumstances:

- Post width is less than 25mm
- Post depth is less than 25mm

- Post height is less than 500mm
- Post spacing is less than 500mm
- Post weight is less than 0.25kg

### **8.3.18 Resetting Stud Data**

To reset the stud data on a wall(s):

- List the wall or walls.
- Go to the 'Stud Data'.
- In 'Stud Arrangement' select 'Auto'. The Actual and Nominal Stud Spacing will change to 0.
- Select 'Amend' to apply.

### **8.3.19 SB – Show Brick**

This command provides a temporary visual representation of brick veneer (shown as half courses) along a wall to determine whether opening locations are correct in relation to the brick veneer setout. These brick sizings are set in the Brick Gauge options in the Panels tab in PSET.

### **8.3.20 SH – Show Heights**

This command allows the user to view all the walls on a layout infilled with a different solid colour for each different height.

### **8.3.21 Sill and Head Check**

When listing an opening, there is a face wind bending check option that can be activated by setting the Check Sill and Check Head options to 'True'. This can be found in the 'Construction Methods' section. If required, the software will automatically add a boxed sill and/or head stiffener.

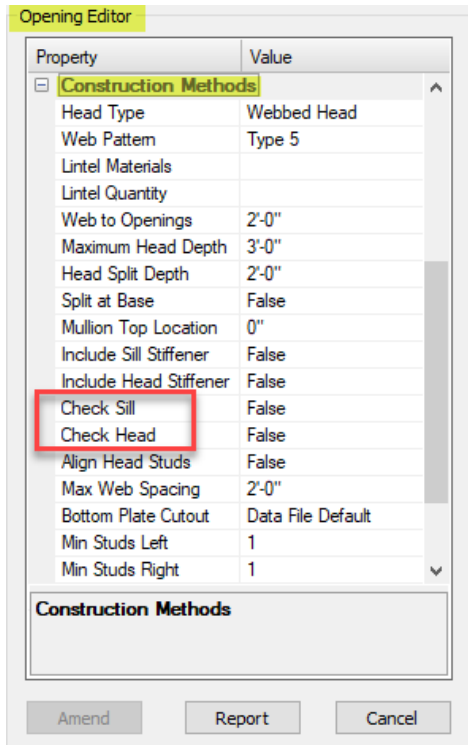

### 8.3.22 Stud Design

The wall stud design calculations are found in the Panel Builder.

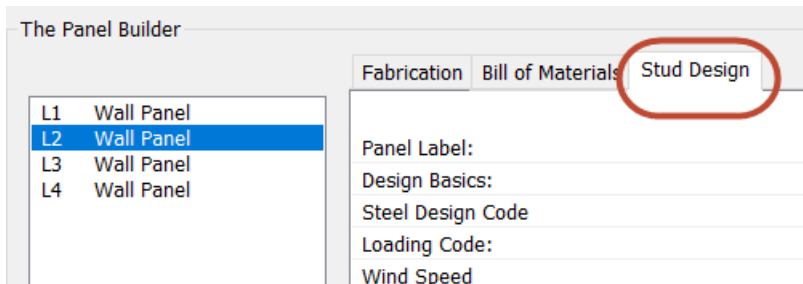

If this tab is not displayed, it means that you probably have the Panel Engineering disabled in the Drawing Sheet Setup (BSET).

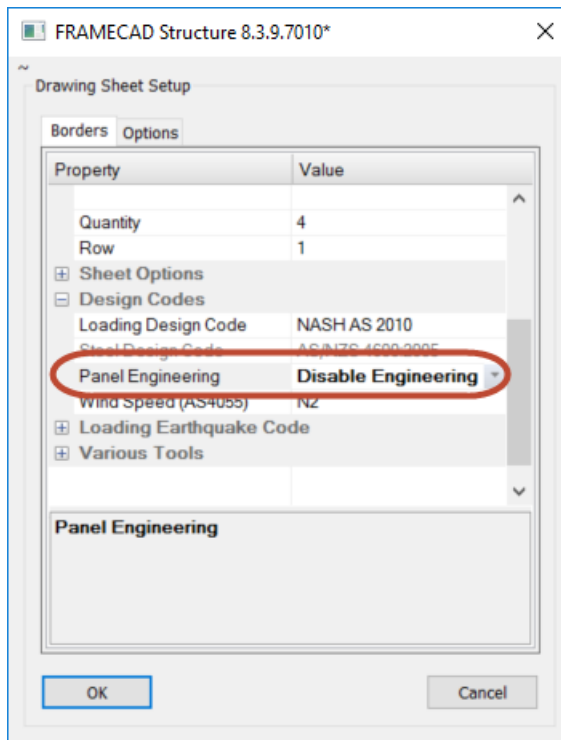

### 8.3.23 Update a Wall in the Detail Sheet When Making Changes to it in the Layout

If you have already built (PPD'd) all your walls and now you need to modify one wall in the layout, use the following steps to update the built wall in the detail sheet.

- make changes to the wall in the layout
- list the modified wall in the layout and select 'Go to detailed panel' go to the detail sheet elevation view for that wall
- PPD the wall from the detail sheet to go to the Panel Builder view
- double click on the panel name in the left-hand column of the Panel Builder to list it
- click on 'Amend' to amend it to the changes as made in the layout
- click on 'Update' to update the view in the detail sheet elevation.

### 8.3.24 Wall Girder Loads

The wall design now evaluates girder load on an opening and includes this load when designing the header. However, this load is still treated as a uniformly distributed load and not a point load therefore an engineer will still be required to check the header or supporting girder truss design for the point load.

A girder load warning message is only applied to the opening header if the supported area on the girder truss is greater than twice the girder truss spacing.

### 8.3.25 Wall Location (External/Internal)

You can now amend and set a panel in the 'Loading Information' properties when listed, as 'Internal' or 'External' without it being automatically overwritten by its physical location as determined by the software.

## 8.4 Roof Detailing

### 8.4.1 Add or Amend Roof Loads

How to make permanent changes or additions to required roof load types e.g. adding Clay Tiles. Any temporary (or one off) changes should be made in the 'Loads' section of the TSET settings.

- Ensure you have the correct System Name selected
- Hold the ALT key down and click on 'Roof Load\*'. This will open a Roof Load Editor dialogue box. Please contact your system administrator if access is denied.
- Add or amend roof loads as required.
- Click on Add/Amend.

Adding or amending roof loads will create a new user data file in the C:\ProgramData\FRAMECAD\FRAMECAD Steelwise\Library directory with the same name as the System Name selected but with 'USER' at the end of the name. Any information within this data file will take precedence over the parent data file.

If you are unable to access the Roof Load Editor, go to your Licence Manager (VER) and see if Sub Edit Feature 2005 is Enabled.

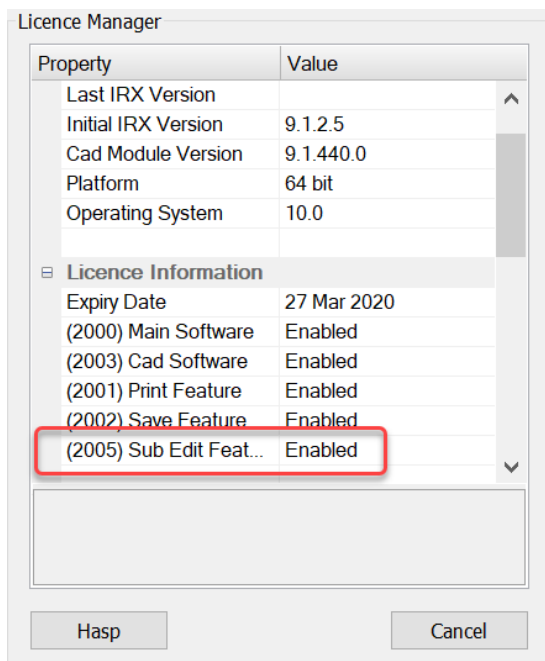

If it is Disabled, you can request it through MyFramecad Care - <https://my.framecad.com/FCADCare>.

### 8.4.2 ADD – Truss Members in Detailing Space

This command allows the user to input new chord, web or rail members into a truss either by point-to-point input or by entity (coding a line).

Also see IW in the "FRAMECAD Steelwise Reference Guide" under 'Editing Commands'.

### 8.4.3 Detail Sheet Border Size

'Border Sized to Fit' option added which makes all the truss elevation borders the same size if preferred. The 'Detail Sheet Options' can be found on the 'Options' tab in TSET.

### 8.4.4 Gable End Roof Type Truss Locations

There is a data file option to locate the first truss back from the gable end truss, either to the face of the truss or to the centre of the truss. This is a data file setting – please create a ticket in MyFramecad to request any data file changes.

### 8.4.5 Lengthening and Shortening Trusses Using the Stretch (ST) Command

If a truss is lengthened by using the ST command, what this does is to increase the span of a truss, therefore the trusses heel heights are maintained, the pitch is maintained, and the overall height of the truss is increased, i.e. the apex of the truss is moved.

If a truss is shortened by using the ST command, the apex position and pitch is maintained but the end shortened is going to be a 'cut off' or 'stop end'. Therefore, in effect the heel height is increased on that end of the truss.

### 8.4.6 Parallel Chord Girder Trusses

When a parallel chord truss supports other oncoming trusses, it will act as a girder. The additional roof area load is added and it's spacing is disregarded. Note: if the parallel chord truss sits on a support line running parallel to it, then the oncoming trusses will load onto the support line and not the parallel chord truss.

### 8.4.7 Setting the height of truncated trusses

Whenever you manually insert or move a truncated truss you will need to change the height of the horizontal top chord. To do this, you need to list the truss using the LI command, go to the 'Height Information' and click on the button to the right of the Truss Height. You will then be prompted to 'select the truss for reference' – this is the truss that you intend changing the height of. Then you will be prompted to 'select a point for height calculation' – this is the heel line (or support line) of the trusses/rafters which run over the top of the truncated truss.

**Note: This operation will not work if you list the truss by double clicking on it. You MUST LI, then select the truss.**

### 8.4.8 TSET – Truss Spacing Types – Truncated Girder Truss

When the 'First Truncated as Girder' is set to 'True', the first truncated truss generated for a hip end will be a girder truss instead of a standard truss. As a result, web members will be aligned with the oncoming hip end trusses and the loads will be calculated using the 'Additional Area' method.

Use this option for roofs with heavy loads or roofs where supported jack trusses are cantilevered past the support line.

### 8.4.9 Truss Bottom Chord Restraints

Bottom chord restraints are determined by what is set in TSET – Layouts – Batten Spacing – Ceiling Batten Spacing. If this value is set to zero, then the Ceiling Tie value will be used (TSET –

Layouts – Truss Spacings – Ceiling Ties), i.e. the Ceiling Batten Spacing will take precedence over the Ceiling Tie value.

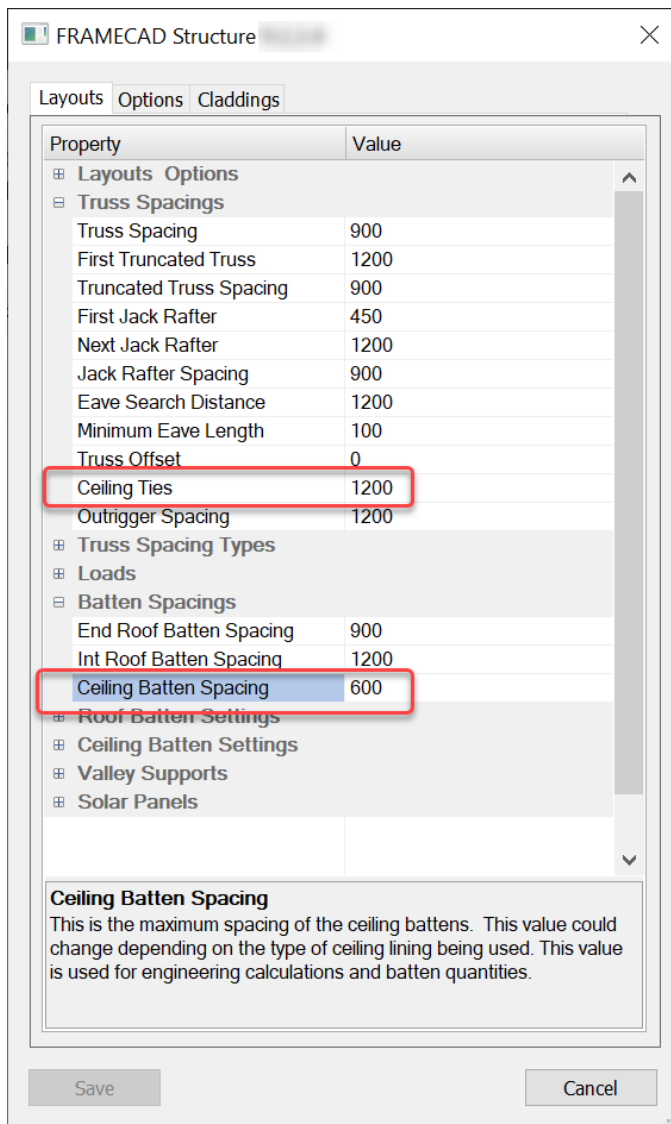

#### 8.4.10 Truss Labelling

If experiencing issues with truss labelling at any stage, try using the PUA command first.

#### 8.4.11 TS (Truss Solar) – Solar Panel Input

This command allows the user to input a solar panel (or similar panel) on top of roof trusses. Size and weight settings can be found in TSET.

#### 8.4.12 TTD – Existing detailed trusses not working

If the 'DEFPOINTS' layer is turned off, the software does not bring up the truss as it doesn't find the reference point.

#### 8.4.13 TUP or LP – Blank Screen on Input

If the TUP or LP command is activated, and the plan zooms out to what appears to be an entirely blank screen when requested to select a location border or source border, this generally means

that there is an entity on the plan that exists a very great distance away from border location. If this is true, then follow the process below:

- Type 'e' for ERASE.
- Type 'all' to select all entities in the drawing. A quantity of entities selected will appear in the command bar.
- Type 'r' to remove selection
- Select entities to remove from selection. The quantity of selected entities will be subtracted from total.
- Press Enter to erase the remaining selected entities.

#### 8.4.14 TUP – Truss Uplift Plan Values

When a truss uplift is plan is created but you don't wish to display all the values below a certain value.

The minimum value can be set in the truss settings 'Report Options' which is in the TSET Options tab.

This is useful if you only wish to display values above a set value for clarity when selecting hold down fixings.

#### 8.4.15 User Truss Creation

User trusses are trusses that follow a roof profile. This is only applicable to truss top chords. Generally, User trusses are an option where a smaller roof block attaches to the end of a hip roof or in other various colliding hip type roofs.

## 8.5 Smart Panels

### 8.5.1 Not Initialized

- Run AECOBJECTS and set to 'On'.
- Restart Steelwise.

### 8.5.2 Add an Opening into a Smart Panel

- Draw a rectangle of the required size and location within the smart panel.
- Type MJ (MEMBER\_JOIN) and select the panel.
- Hold the ALT key down and select the opening polyline. All framing in the opening will be subtracted from the panel.

**Note:** This process can also be used to create notches in the corners and edges of panels.

### 8.5.3 Rake (Slope or Pitch) a Smart Panel

- List (LI) the smart panel
- Under AEC Basics, change the '3D Raking Angle' to the desired slope.
- Change the '2D Raking Direction' to suit the required slope direction. The arrow indicator on the panel will change to suit.

- The PRA (PANEL\_RAKE) command can also be used to rake a smart panel.

#### 8.5.4 How to reshape a Smart Panel on the layout:

- In the layout, run the MD (MEMBER\_DIVIDE) command
- Set the number of segments required to divide the side of a panel by (2 will add one extra grip)
- Click on the smart panel
- Once the panel is selected, then click on the segment that you need to add the extra grip(s) to.
- Select the panel to highlight the grips, then click on the grip that you wish to move.
- Stretch the grip to the required location
- Important: LI the panel and go to 'Other Tools – Rebuild Blocks' and activate the 'Press to Rebuild' button
- Now your panel is ready to send to the Panel Builder (SPD) and/or Insert Block

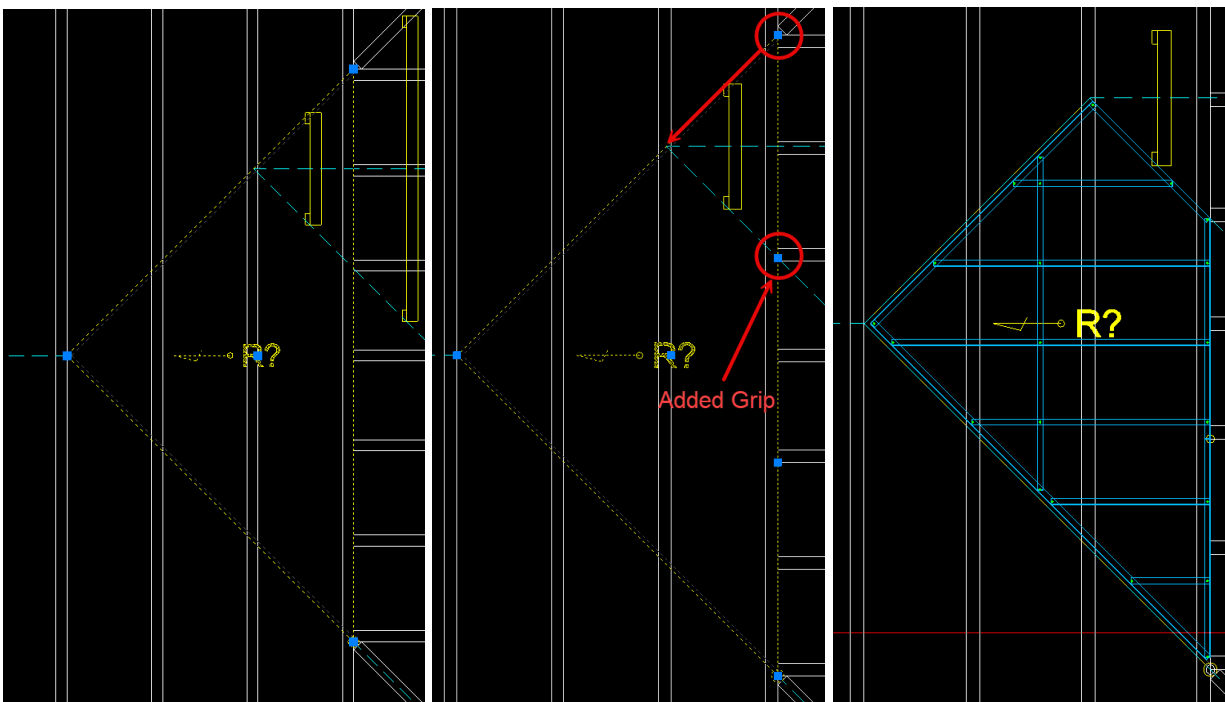

#### 8.5.5 Working on Jobs with Old Ceiling Panels

- Run the FCMIGRATE command in the layout
- SPD the ceiling panels and rebuild.

## 9 Steelwise Menu & Commands

---

### Steelwise:

Detail/Frame Builder	DET (TTD/PPD/JJD)
Framing Item / Member Item	ADD
List Item	LI
Reset CAD Environment	DO_ONCE
Reset All (Reset program to default settings)	RESETALL
Software Version	VER
Spool Print	SP
BIM Attach	BIMATTACH
Create FIM Layout	CREATELAYOUT

### Settings:

Border Setup	BSET
Floor Settings	JSET
Panel Settings	PSET
Truss Settings	TSET

### Panels/Walls:

Bath Nog	PBN
Build Studs	PBS
Calculate Bracing	PCB
Defined Door Input	<i>See Below</i>
Insert Brace	PIB
Lap Beam	PLB
Load Path	LP
Opening Input	ADD
Opening to Brick	PFB
Panel Auto Break	PAB
Panel Builder	PPD (or DET)
Panel Input	PD (or ADD)
Panel Notch	PN
Panel Rake	PRA
Panel Stack	PST
Panel Stack – Insert Wall	IW
Show Brick	SB
Show Heights	SH
Special Noggin	PSN
Stud Array	PSA
Stud Array Copy	PSC
Update All (Re-Engineer Walls)	PUA
User Defined Door	UD

User Defined Window	UW
---------------------	----

**Defined Door Input:**

Aluminium Door	AD
Aluminium Window	AW
Archway Opening (Square Set)	AR
Cavity Slider	CS
External Door	ED
Face Slider	FS
Passage Door	PA
Robe Door x1	R1
Robe Door x2	R2
Robe Door x3	R3
Internal Slider x2	S2
Internal Slider x3	S3
Internal Slider x4	S4

**Trusses:**

Add Point Load	TPL
Add Support	AS
Box Gutter	BG
Box Member	BM
Code Member	CM
Code Roof Line	RL
Code Support Line	SL
Convert to Hexagonal End	CTH
Create Roof Lines	CRL
Insert Web	IW
Rebuild Eaves	TRE
Roof Shape Input	RS
Solar Panel	TS
Truss Builder	TTD (or DET)
Truss Builder (Silent – Re-engineers without going to Truss Builder)	-TTD
Truss Connections	TC
Truss Layout Input	TD
Truss Uplift Plan	TUP

**Joists:**

Code Support Line	SL
Floor Recess	FR
Floor Sheet Input	FSD
Floor System Wizard	FD
Joist Builder	JJD (or DET)

Joist Builder (Silent – Re-engineers without going to Joist Builder)	-JJD
Joist Layout Input	JD (or ADD)
Joist Service Hole	JSH

**Smart Panel:**

Ceiling Panel	SC
Floor Panel	SF
Roof Panel	SR
Panel Builder	SPD

**Editing:**

Add Support	AS
Box Member	BM
Break Member	MB
Copy Member	C
Copy Layer	CL
Crossing Member	MX
Cut Member	MC
Divide Member	MD
Extend Member	ME
Fillet Member	MF
Inherit Properties	IP
Insert Web	IW
Join Member	MJ
Lengthen Member	ML
Mirror Member	MI
Move Member	M
Offset Member	MO
Member Update	MU
Reverse Frame or Member	RF or MR
Section Mark	SM
Special Erase	SE

**Miscellaneous:**

Copy to Model Space	C3D
Centered	CTR
Copy Posts	CC
Copy Roof Layout	RCR
Copy View	CV
Create Support Lines	CSL
Explicit Tool	ET
Find Item	FFIND

Gridline	GL
Insert Detail	ID
Integrity Check	IC
Label All	LA
List Item	LI
Quick Text Input	QT
Reference Point	REF
Revision Cloud	REV
Show Orientation or Engineering Failures	SHOW
Steel Profiles	SS
Temporarily Hide Entity	TEMPHIDE
Text to CNC	TEXT_CNC

**Dimension:**

Aligned Dimension	DA
Dimension Guidelines	DG
Horizontal Dimension	DH
Line Dimension	DL
Linear Dimension	DM
Ordinate Dimension	DO
Vertical Dimension	DV

**Reports:**

Beam Summary	POB
On Page Joist Accessories	JOA
On Page Opening Summary	POO
On Page Panel Accessories	POA
On Page Joist Summary	JOS
On Page Panel Summary	POS
On Page Post Summary	POP
On Page Rafter Summary	ROS
On Page Roof Area	RA
On Page Summary	OR
On Page Truss Accessories	TOA
On Page Truss Summary	TOS
Report	REP
Summary Report	SUM

**View:**

All Layouts 3D	A3D (or 3D)
Clear Border	CB
Copy View	CV
Go To View...	V
Initial View (View Restore)	VR

Joist 3D	J3D
Layout / Detail Toggle	ZZ
Make View	VM
Move View	MV
Next View	VV
Panel 3D	P3D
Previous View	X
Smart Panel 3D	S3D
Truss 3D	T3D
Create 3D Views (in a separate tab)	VVD

**Layer Control:**

Copy Layer	CL
Current Layer	LC
Erase Layer	LE
Freeze Layer	LF
Isolate Layer	IL
Layer Show All	LS
Temp Layer Add	LX
Temp Layer 1 to 5 Add	LX1,...LX5
Temp Layer Toggle On/Off	LT
Temp Layer 1 to 5 Toggle On/Off	LT1,...LT5
Temp Layer Toggle All On/Off	LTA
Visual Controls	VC

**Exports:**

ACNC Export All	ACNC
CNC Export	CNC
Export As...	EXPORT
IFC Export	IFC
Nexa Upload	NEXA
PDF Export	PDF
RFY Export	RFY
STP Export	STP
VRML Export	VRML

**Help:**

Engineering Guide	
Procedures Guide	
Reference Guide	
Release Notes	
Software Version	VER
Updates and How To's	

Refer to the Steelwise Reference Guide for more detailed information on each command.