

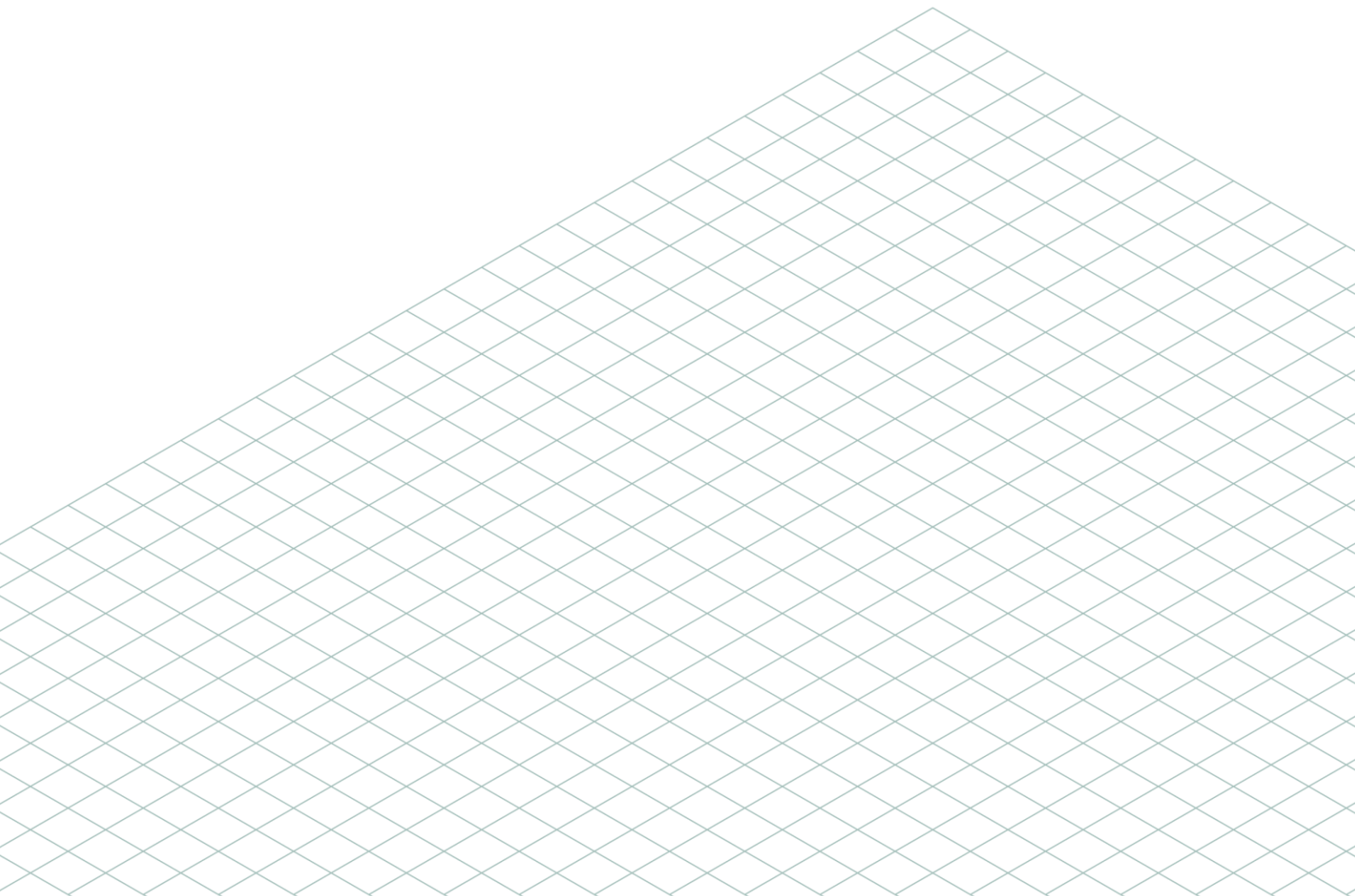

FRAMECAD Steelwise Procedures Overview



Disclaimer

This document has been published for the purpose of providing information of a general nature only.

Further, no guarantee, warranty, or any other form of assurance is given as to the accuracy, currency or completeness of the information provided.

Accordingly, any reliance on, or use, by you of any information contained within this document for any purpose whatsoever shall be entirely at your own risk, and any liability to you is expressly disclaimed to the maximum extent permitted by law.

Intellectual Property Notice

ALL INFORMATION CONTAINED IN THIS DOCUMENT IS SUBJECT TO CHANGE WITHOUT NOTICE. THIS DOCUMENT SUPERSEDES ALL PREVIOUS DOCUMENTS.

FRAMECAD® and the FRAMECAD® logo are trademarks of FRAMECAD Limited.

Reproduction of this document and all material included herein is prohibited, except with the prior written consent of FRAMECAD Limited.

Copyright 2024 FRAMECAD Limited.

Confidentiality

This document and all material included herein is confidential to FRAMECAD Limited and must not be disclosed to any other party or used to the detriment of or other than as authorised by FRAMECAD Limited.

This document and all material included herein shall be returned to FRAMECAD Limited Immediately upon request.

Contents

| | |
|--|-----------|
| Disclaimer | i |
| Intellectual Property Notice | i |
| Confidentiality | i |
| Contents | ii |
| 1 Installation and Setup | 1 |
| 1.1 System Requirements | 1 |
| 1.2 Software Installation | 1 |
| 1.3 Software Licencing | 2 |
| 1.4 Software Startup | 2 |
| 1.5 Software Documentation | 4 |
| 2 Software Overview | 5 |
| 2.1 Software Capabilities..... | 5 |
| 2.2 Modelling Environments..... | 7 |
| 2.3 System Settings..... | 9 |
| 2.3.1 Border Settings (BSET) | 9 |
| 2.3.2 Panel Settings (PSET)..... | 12 |
| 2.3.3 Truss Settings (TSET) | 13 |
| 2.3.4 Joist Settings (JSET) | 14 |
| 2.4 Framing Model Objects | 14 |
| 2.4.1 Layouts Space Objects | 14 |
| 2.4.2 Detail Space Objects | 18 |
| 2.5 Framing Functions and Outputs | 23 |
| 2.5.1 Layouts Space | 23 |
| 2.5.2 Detail Space | 33 |
| 3 Basic Procedures | 37 |
| 3.1 Initial Job Setup Process | 37 |
| 3.2 Wall Detailing Process – Stage 1 | 37 |
| 3.3 Truss Detailing Process..... | 38 |
| 3.4 Floor Joist Detailing Process | 40 |
| 3.5 Wall Detailing Process – Stage 2 | 41 |
| 4 Detailed Procedures | 42 |
| 4.1 Tutorial example..... | 42 |
| 4.2 Job Setup | 42 |
| 4.3 Building/Slab Layout Plan..... | 49 |

| | | |
|----------|---|------------|
| 4.4 | Wall Panel and Beam Input..... | 54 |
| 4.5 | Roof Theory | 63 |
| 4.6 | Truss Layout Input..... | 66 |
| 4.7 | Truss Detailing | 79 |
| 4.8 | Floor Joist Input..... | 86 |
| 4.9 | Floor Member Usage for Engineering..... | 94 |
| 4.10 | Floor Joist Engineering | 96 |
| 4.11 | Floor Joist Detailing | 97 |
| 4.12 | Final Wall Panel/Beam Design | 98 |
| 4.13 | Wall Panel and Beam Detailing..... | 103 |
| 4.14 | Wall Panel Engineering..... | 104 |
| 4.15 | Ceiling, Roof and Floor Panel Detailing (Smart Panels)..... | 104 |
| 4.15.1 | Creating Ceiling Panels..... | 104 |
| 4.15.2 | Editing Ceiling Panels | 106 |
| 4.16 | Creating Roof and Floor Panels..... | 107 |
| 4.17 | Other Commands..... | 108 |
| 5 | Steelwise Menu & Commands | 109 |
| 6 | Appendix A | 114 |
| 6.1 | Tutorial Drawing..... | 114 |
| 6.2 | Tutorial Outputs | 115 |

1 Installation and Setup

1.1 System Requirements

The following is a list of recommended requirements for FRAMECAD Steelwise to run effectively:

- Intel® Core i7 processor or equivalent
- 32GB RAM
- 1GB free disk space (more for saved job files)
- Windows11 – 64-bit (**must** be a legitimate version of Windows otherwise software issues will occur)
- Only 64-bit Operating System is supported

Note that we also recommend keeping the file name length to a minimum and save to a location keeping the subdirectory quantities shallow, i.e. don't have the job file buried under too many subdirectories.

1.2 Software Installation

1. If you are currently running older versions of the software and wish to clear all settings back to factory default, open the program and run RESETALL. This will clear the registry which is basically the same as if you were to do a clean install on a new computer. Ensure you have saved any jobs you are currently working on as the program will automatically shut down after this operation.
2. Download the 'FRAMECAD Steelwise Full Install' installation file from the **FRAMECAD Communities** website: <https://communities.framecad.com/>

Access information for the **FRAMECAD Communities** website is provided on your software purchase.

3. Double click the file to launch the software installer. Follow the prompts on the installer software to complete the **FRAMECAD Steelwise** software installation.

The Steelwise software will be installed into the following directory:

C:\Program Files\FRAMECAD\FRAMECAD Steelwise

The Steelwise Data, Documents, and Libraries will be installed into the following directory:

C:\ProgramData\FRAMECAD\FRAMECAD Steelwise

NOTE: By default, the ProgramData directory is hidden by the MS Windows operating system. To access this folder, you will have to go to the 'View' menu in your 'File Explorer' and click on the checkbox for 'Hidden Items'.

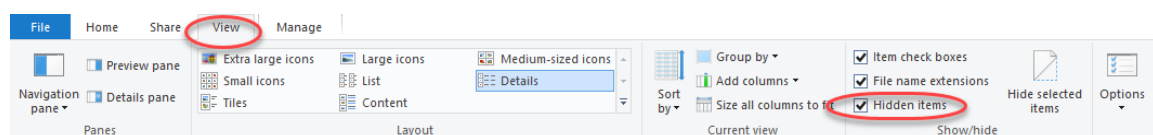

Like many system folders on Windows, the '**ProgramData**' folder is hidden by default since it contains sensitive app information. Deleting or changing the files inside it by mistake may result in the loss of crucial data, and then your system might not work properly.

If your company is supplied with a customised data file, then this must be copied to the **C:\ProgramData\FRAMECAD\FRAMECAD Steelwise\Library** directory.

1.3 Software Licencing

FRAMECAD Steelwise requires a valid security 'Softkey' licence to operate. The softkey licence includes a unique ID number and a licence expiry date (this license is updated each year upon renewal of your licence contract).

NOTE: A 30-day trial licence is automatically installed with the software. This trial licence enables full software operation with the exception of Printing and RFY export.

The Status and Expiry Date of your software licence may be obtained by accessing the Licence Manager via the **Software Version** from the 'Steelwise Help' Menu or running the **VER** command.

Other information displayed in the Licence Manager include:

Current IRX Version – This is the version of Steelwise that is currently installed. This is the number that should be quoted whenever you are asked for a Steelwise version number by FRAMECAD support staff. This number also appears at the top of all Steelwise dialogue boxes.

Last IRX Version – This is the IRX version that was being run when the job was last saved.

Initial IRX Version – This is the IRX version that was being run when the job was first started.

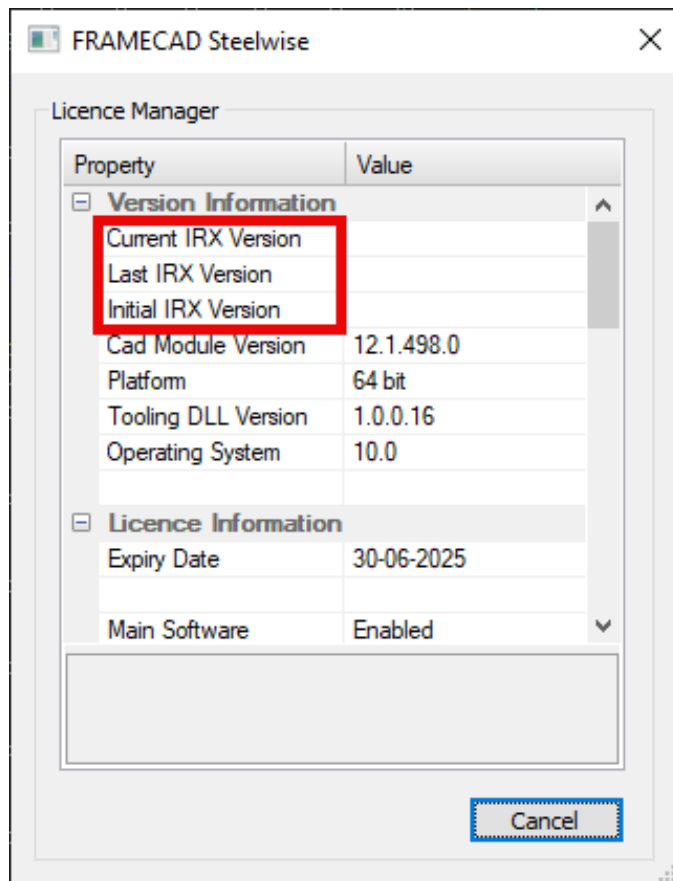

CAD Module Version – This is the version number of the IntelliCAD Platform.

1.4 Software Startup

1. Launch the Steelwise program from the desktop shortcut (option to create during installation), or go to the Windows Start menu and select the execution shortcut:

– **All Programs – FRAMECAD - Steelwise - FRAMECAD Steelwise**

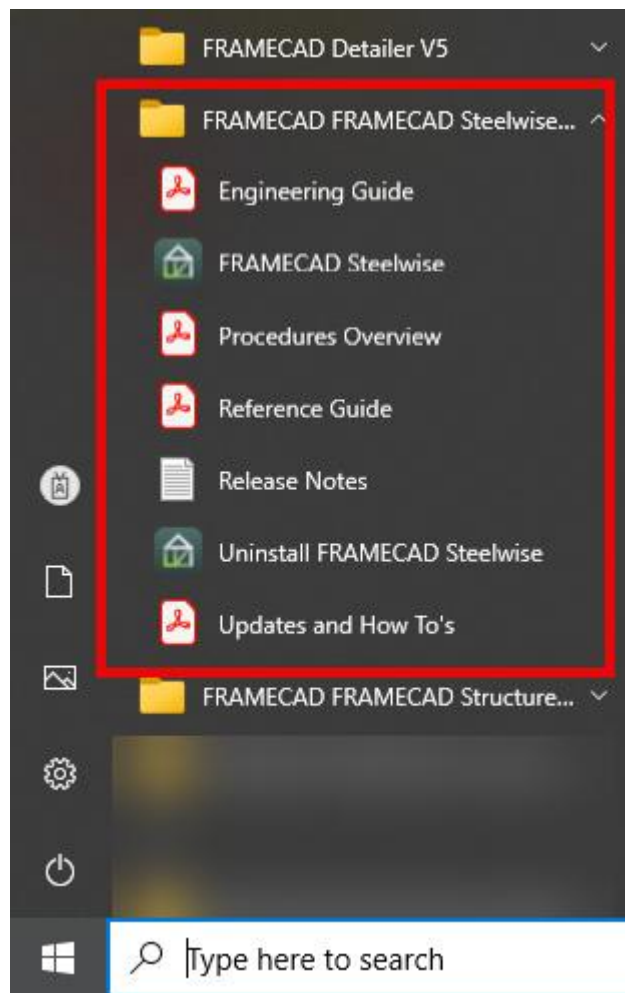

NOTE: The start menu also provides the following shortcuts:

Uninstall FRAMECAD Steelwise: Runs software uninstall application.

Manuals

Engineering Guide: Opens a pdf of the Engineering manual.

Procedures Overview: Opens a pdf of the software usage overview manual.

Reference Guide: Opens a pdf to all the Steelwise commands as well as a section of common How To's.

Release Notes: Opens a text file showing the latest software changes.

Updates and How To's: Opens a pdf of the latest software updates in a bit more detail as well as a section of common How To's and a full list of commands.

2. After opening the program for the first time, the CAD environment will be set automatically. If for some reason the 'Steelwise' menu or aliases do not appear or become corrupt, type DO_ONCE in the Steelwise Command line. This ensures that the CAD environment is set to the default values required for the User Operating System.

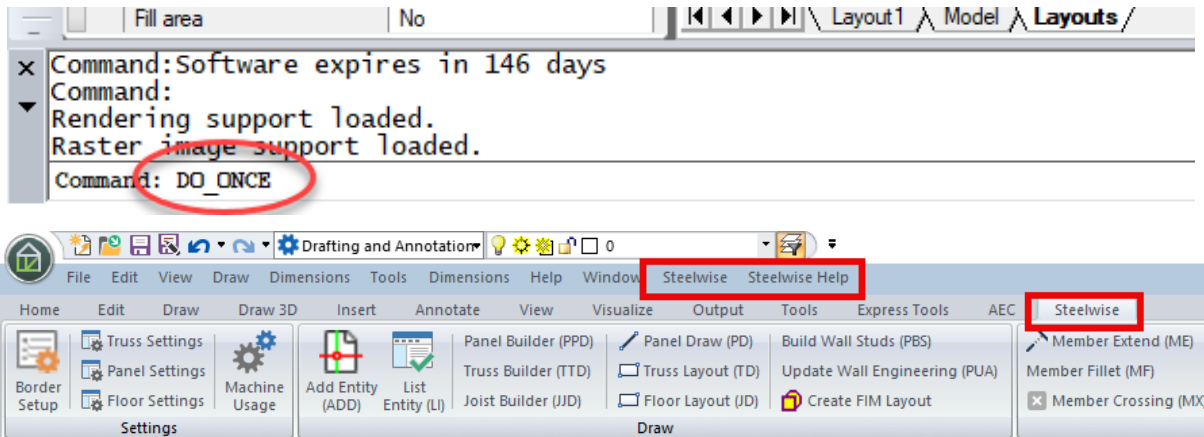

3. If the top menu bar doesn't appear, you can turn it on by right clicking anywhere in the ribbon menu and selecting 'Menu Bar'.

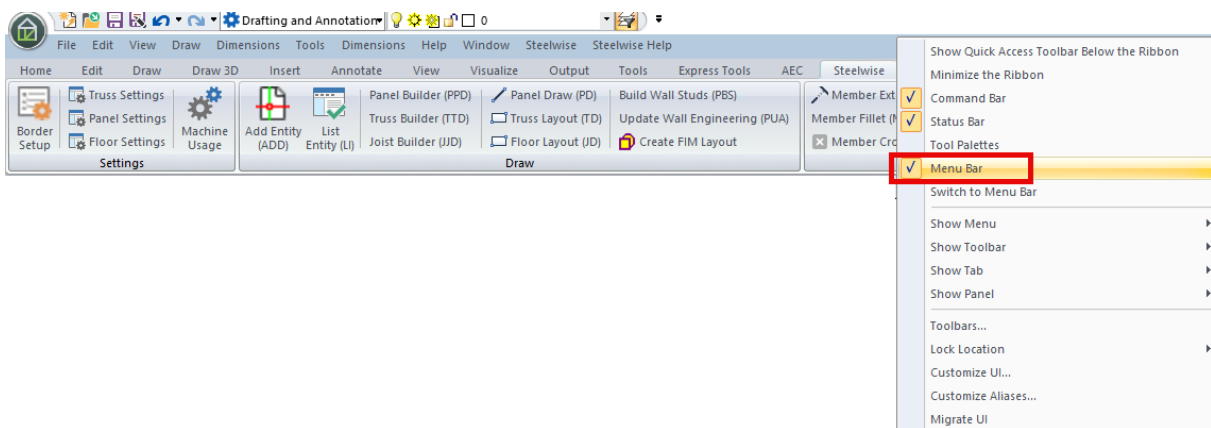

1.5 Software Documentation

The following user documentation is provided with the software installation.

1. **FRAMECAD Steelwise Procedures Overview**

This manual covers Installation and Setup, Software Overview, a basic overview of Procedures for generating a Design, and a listing of Commands.

2. **FRAMECAD Steelwise Engineering Guide**

This manual provides a description of the Engineering function and the Engineering parameters of the FRAMECAD Steelwise software.

3. **FRAMECAD Steelwise Updates and How To's**

This document outlines new information on software updates. It also provides a 'How To' section and a list of all the available commands.

4. **Release Notes**

A historical document outlining any changes in the software.

5. **FRAMECAD Steelwise Reference Guide**

This manual provides a description of each FRAMECAD Steelwise Command. There is also a 'How To' section within this manual.

All manuals/documents can be accessed through the Windows Start Menu or the Steelwise Help menu.

2 Software Overview

2.1 Software Capabilities

FRAMECAD Steelwise is a software package for the Detailing and Engineering of light gauge cold formed steel framing (CFS).

Steelwise has extensive CAD structural draughting functionality, plus a specialist CFS design module. The CAD and Design module operations are all fully integrated in the one interface to produce a whole building design.

The capabilities of the CFS Design module are:

Wall Panels

- Wall layout tools
- Automated frame panel detailer for specified framing system
- Stud member engineering design for uniform roof, floor, and face wind loading
- Top plate member engineering design for truss and floor joist loading
- Wall header beam engineering design for uniform and concentrated roof and floor loading
- Opening jamb stud and brace collector stud take-down loads
- Wall bracing capacity calculator
- Wind and seismic lateral load calculator
- Component and prescriptive Accessory Material Report generation
- CFS Component CNC fabrication model generation and export

Roof Trusses

- Roof layout generator and tools
- Automated truss frame detailer for specified framing system
- Truss engineering design for uniform loading
- Truss hold-down load calculator
- Component and prescriptive Accessory Material Report generation
- CFS Component CNC fabrication model generation and export

Floor Joists

- Floor layout generator and tools
- Automated floor joist detailer for specified framing system
- Floor Joist engineering design for uniform loading
- Concentrated loads for floor beams
- Drag loads
- Service hole strength calculator
- Component and prescriptive Accessory Material Report generation
- CFS Component CNC fabrication model generation and export
- Floor Truss / Joist Design Drawings to AISI Standard

For more detailed information on the software capabilities, please read section 2 of the FRAMECAD Steelwise Engineering Guide. This can be found in the Steelwise Help dropdown menu.

Software Operation

FRAMECAD Steelwise software operates on the FRAMECAD IntelliCAD platform.

The operation of Steelwise is CAD based. This means that the drawing operations and the command system of Steelwise will be familiar to users of common Windows based CAD software systems. However, this also means that a basic knowledge of CAD operation is a requirement for the effective use of the software. It is recommended that users not familiar with CAD drawing receive some basic training in CAD by a professional training institute to supplement their FRAMECAD Steelwise training.

FRAMECAD Steelwise is a **Menu** based Windows program. The Main Menus are located along the top bar of the application windows. The steel design and detailing operations of the software are located in the Steelwise Menu. Shortcut **Toolbars** may be activated as per standard for Windows and CAD software.

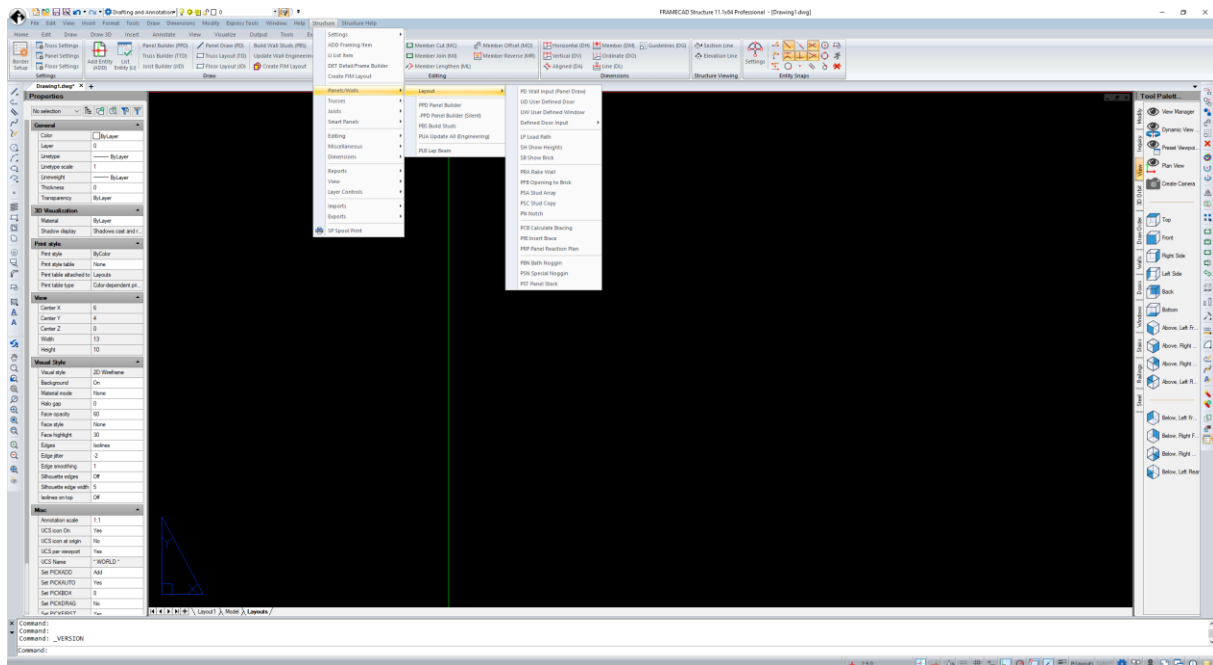

A **Ribbon Bar** appears below the menu bar. These are effectively customised toolbars that provide easy access to common commands. Users should select the "Steelwise" Ribbon for general use.

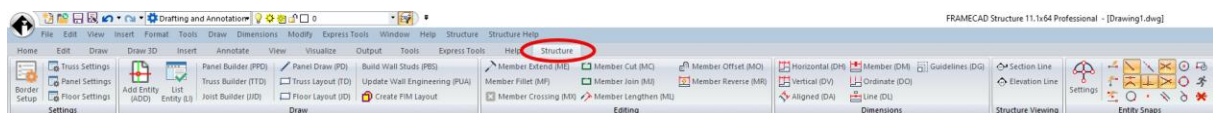

Software operations may also be run by entering a corresponding **Command Alias** in the Steelwise Command Line, found at the bottom of the application. Detailers typically find the use of the command line to be the most efficient way to use the software. This document references a command alias in **BOLD** where applicable.



If the Command Bar is missing or disappears during operation, you can easily re-activate it by clicking on the grey bar at the bottom of the application.

A full list of Design module commands and aliases are provided at the end of this document.

Should users wish to create additional aliases, this can be done through the IntelliCAD customization dialog box. This dialog box is located on the main down menus. To access this go 'Tools' >

'Customize', then select the 'ALIASSES' tab on the top right-hand end of the dialog box. For more information on this topic please refer to the IntelliCAD help files from the 'Help' menu.

Note: Any changes made to aliases will be overwritten whenever a new release is installed or if either of the DO_ONCE or RESETALL commands are activated.

2.2 Modelling Environments

A FRAMECAD Steelwise CFS Building model is generated using three modelling space types: Users may move between the modelling spaces by selecting the relevant space Tab at the base of the drawings space (immediately above the command line).

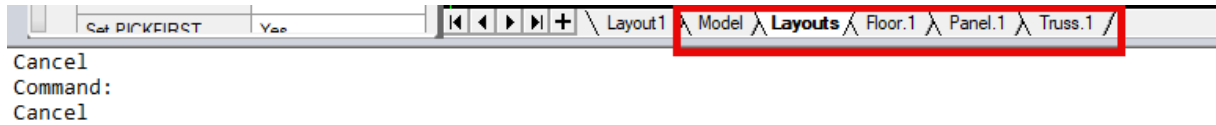

Layouts Space: Used for drawing of layouts and generation of the building model. Models are generated in a series of drawing borders, which may also be used as structural layout drawings. Model each sub-assembly in a separate border, e.g. for base slab, ground floor walls, first floor joist, second floor joists & roof trusses use 5 borders for layouts plus additional borders for layout details as required.

The **Layouts** space is where you should run the **BSET** command from within.

NB. Do not use the Layout1 space.

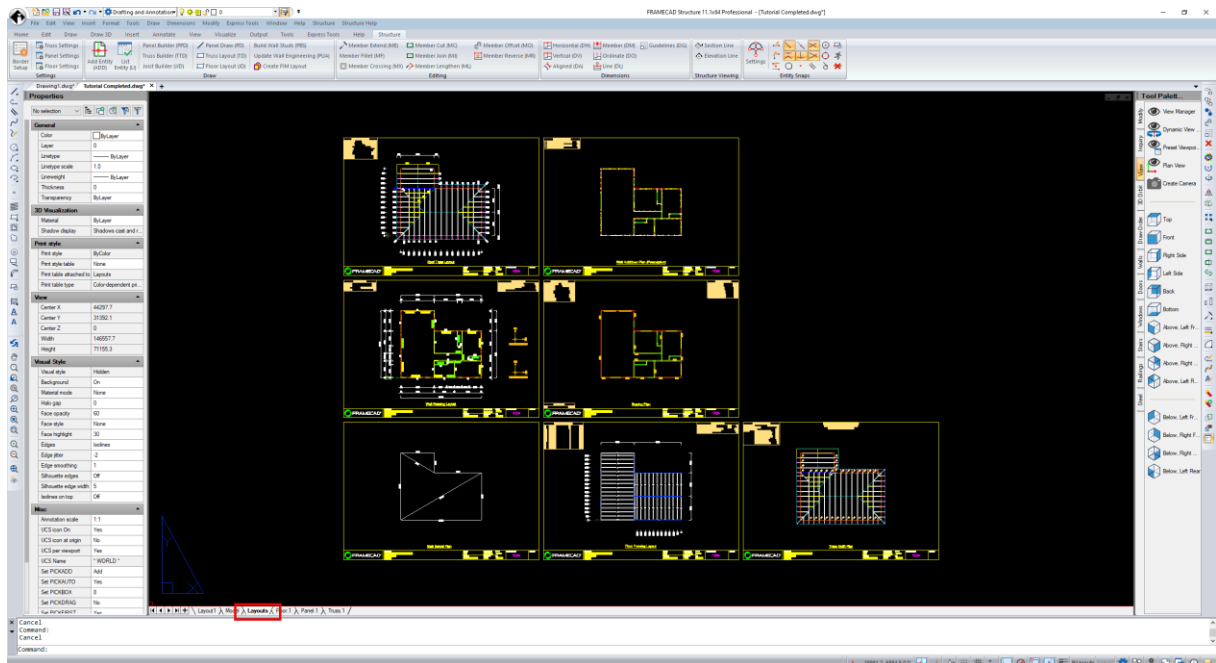

Model Space: Used to show 3-D Views of the Building Model for model review. Selected views from model space may be generated using Viewports in the Layout space borders for presentation purposes.

The 3D Model is generated from the Layouts and Detailing building Model using the Layout Steelwise 3D Commands (A3D, T3D, J3D, P3D and S3D).

NOTE: The Model Space will function as both the Layouts Space and the Model Space if the **BSET** command is run from the Model space.

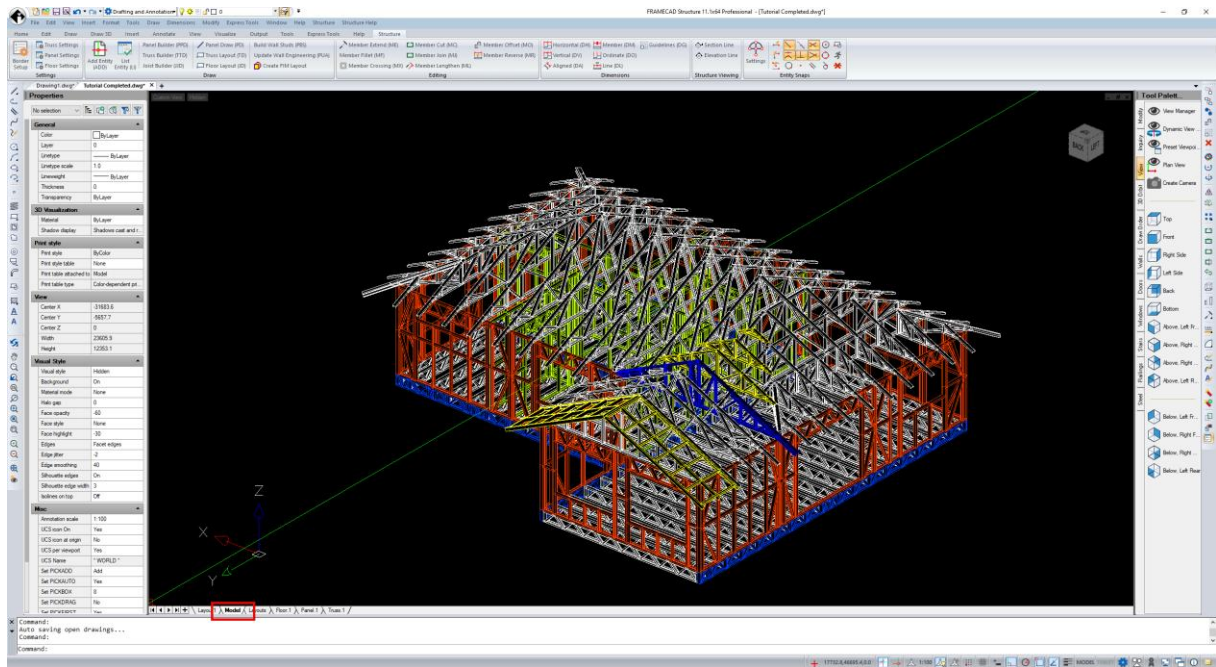

Detail Space: Used to display detail drawing sheets of each generated frame.

Detail Space and Detail Drawings are automatically created using the **'To CAD'** option on the Frame Builder function forms; Wall Panels – **PPD** command, Smart Panel – **SPD** command, Roof Trusses – **TTD** command, Floor Joists – **JJD** command.

The name of each space reflects the frame type; Truss, Floor, Walls and Smart Panel (Users may manually edit these names – e.g. Ground Floor Walls). Multiple Detailing spaces are typically generated for a project, usually one for each sub assembly.

Users may edit or annotate detailed frames and drawings as required prior to publishing. Changes to frame members made in the Detailing Spaces are captured in the building model and reflected in the Model and Layouts spaces

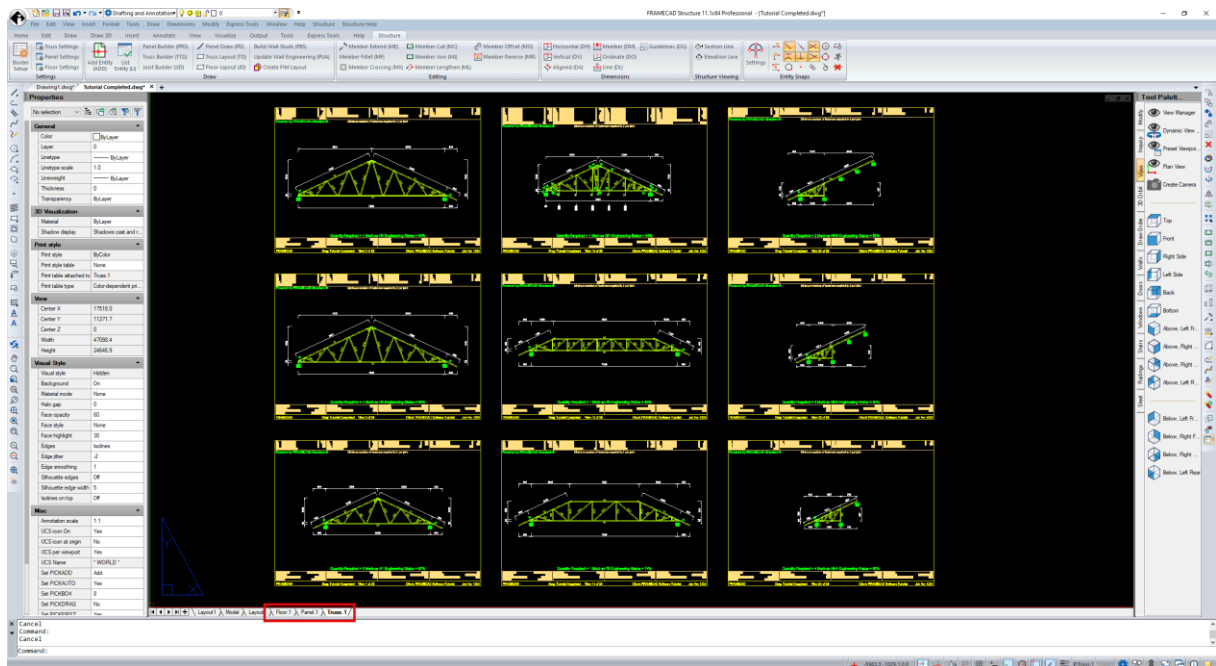

NOTE: The auto generated **Layout1** space is not used for the CFS model. It may only be used for general CAD operations.

2.3 System Settings

The Steelwise software generates a CFS building model for a user selected building system. The building system parameters are selected in four main setting forms - **BSET, TSET, PSET, JSET** (use command alias or select from the 'Steelwise' > 'Settings' dropdown menu).

The Steelwise system settings must be reviewed and amended as required prior to the commencement of any Design project.

The Framing Systems for the building are selected from the available range of **System Data Files** that have been specifically developed for the FRAMECAD manufacturing systems. **It is essential that the user selects the System that is appropriate for their manufacturing systems.** Consult your FRAMECAD software trainer or service staff on the correct choice

2.3.1 Border Settings (BSET)

Sets overall project settings, including Project Information (Client Options), Units (Sheet Options) and Design Parameters (Engineering - Design Codes).

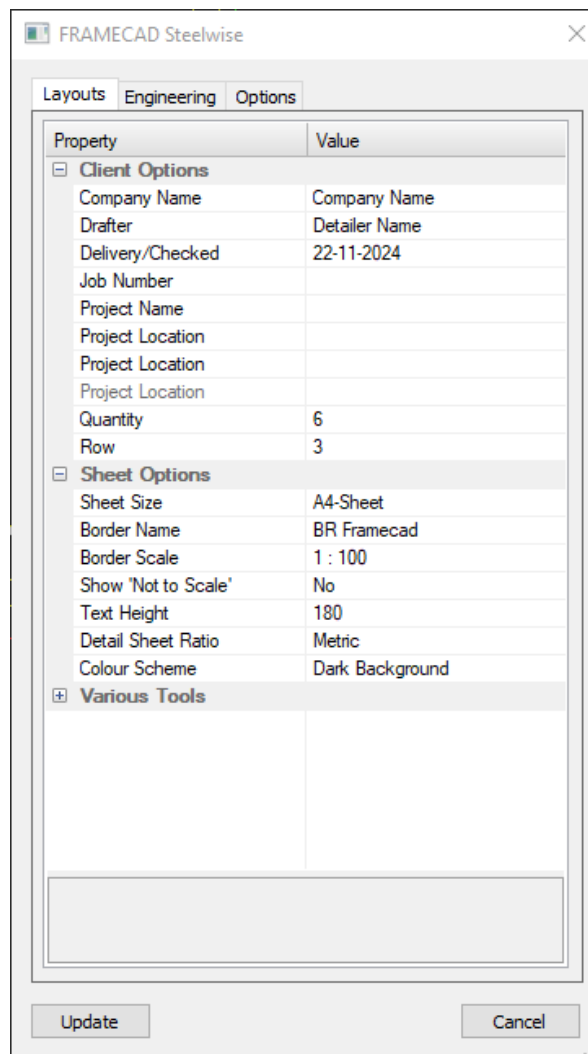

| Property | Value |
|-----------------------|-----------------|
| Client Options | |
| Company Name | Company Name |
| Drafter | Detailer Name |
| Delivery/Checked | 22-11-2024 |
| Job Number | |
| Project Name | |
| Project Location | |
| Project Location | |
| Project Location | |
| Quantity | 6 |
| Row | 3 |
| Sheet Options | |
| Sheet Size | A4-Sheet |
| Border Name | BR Framacad |
| Border Scale | 1 : 100 |
| Show 'Not to Scale' | No |
| Text Height | 180 |
| Detail Sheet Ratio | Metric |
| Colour Scheme | Dark Background |
| Various Tools | |
| | |

Setting Drawing Units

The Drawing and Engineering **Unit Type** (Metric or Imperial) can only be modified the first time the BSET command is run. If Imperial Units are selected, the font in the BSET form changes to **blue** for easy recognition.

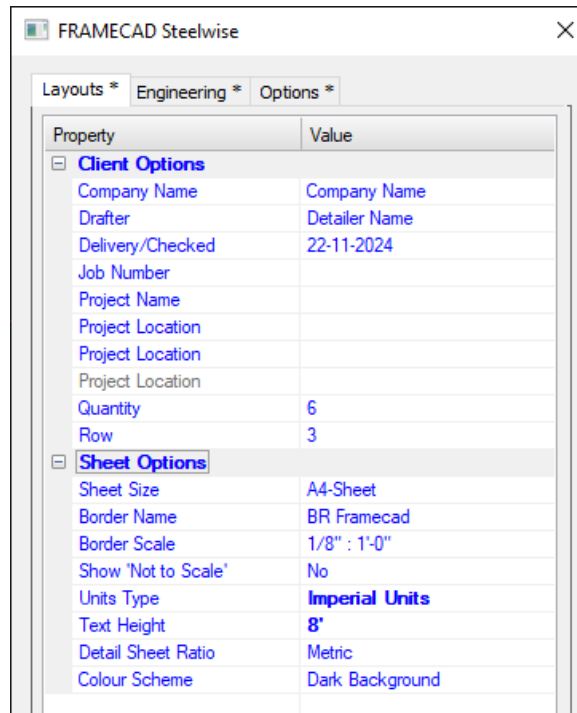

Design Control Settings

Sets design codes versions and design parameters which apply to the whole job. These can be modified during a project.

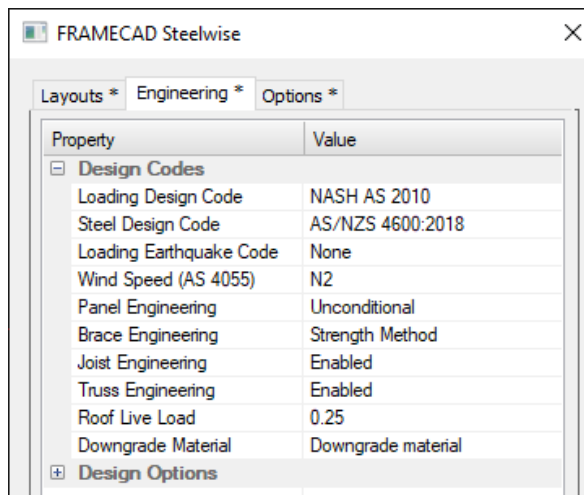

Engineering Control Options

Under the 'Design Codes' section there are also options for Panel, Brace, Joist and Truss Engineering control. These enable users to turn the Engineering function on or off and specify how and when Engineering is performed. Users may choose to disable the Engineering function if prescriptive engineering is to be used for the job or may wish to limit how often Engineering is updated during model drawing and editing (as continual updating may slow this process).

Panel Engineering:

- Unconditional – Full engineering is performed unconditionally on PPD from layout.
- Automatic – Full engineering is performed initially on PPD, then only if changes are detected.
- Semi-Automatic – An 'option to update' dialogue is presented on PPD if changes are detected.

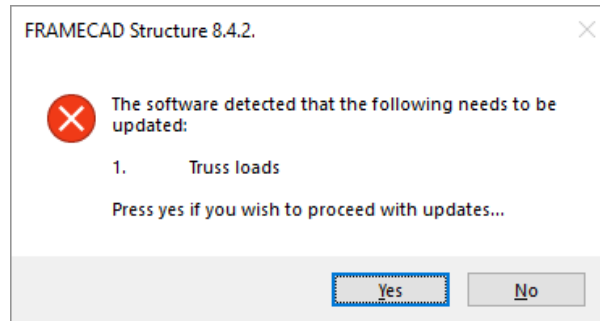

- Manual – Engineering is only performed when the user selects **Update Wall Engineering** (PUA) in the layout or selects the 'Engineer All' option in the Panel Builder (PPD).
- Disabled – Engineering fully disabled. Build Wall Studs (PBS) is required to build studs.

Brace Engineering:

- Strength Method - Check for total bracing system strength compared with total demand.
- Rigid Diaphragm - Check for bracing frame capacity and drift considering rigid diaphragm
- Disabled – Engineering for bracing fully disabled.

Joist Engineering – Enabled/Disabled

Truss Engineering – Enabled/Disabled

Note: PPD from wall elevations does not update engineering. Engineering is only updated when using the PPD command from the wall layout or by running the PUA command from the wall elevations.

Drawing Borders

Selecting the **Insert** button on the **BSET** form initialises the project and generates the model layout borders. By default, this command is run in the **Layouts** space. To generate borders in the Model space (if required) first select the Model space Tab before running the command.

Once the layout borders have been inserted, the location of the borders must not be changed. It is, however, possible to add or remove layout borders to the selected space by running the BSET command again and editing the 'Quantity'.

Be aware that the Model space is generally reserved for the 3D model of the building, therefore any layouts generated in this tab will be shared with the 3D view.

2.3.2 Panel Settings (PSET)

Sets Wall Panel Framing System (Panel Information) plus a wide range of loading and geometry parameters.

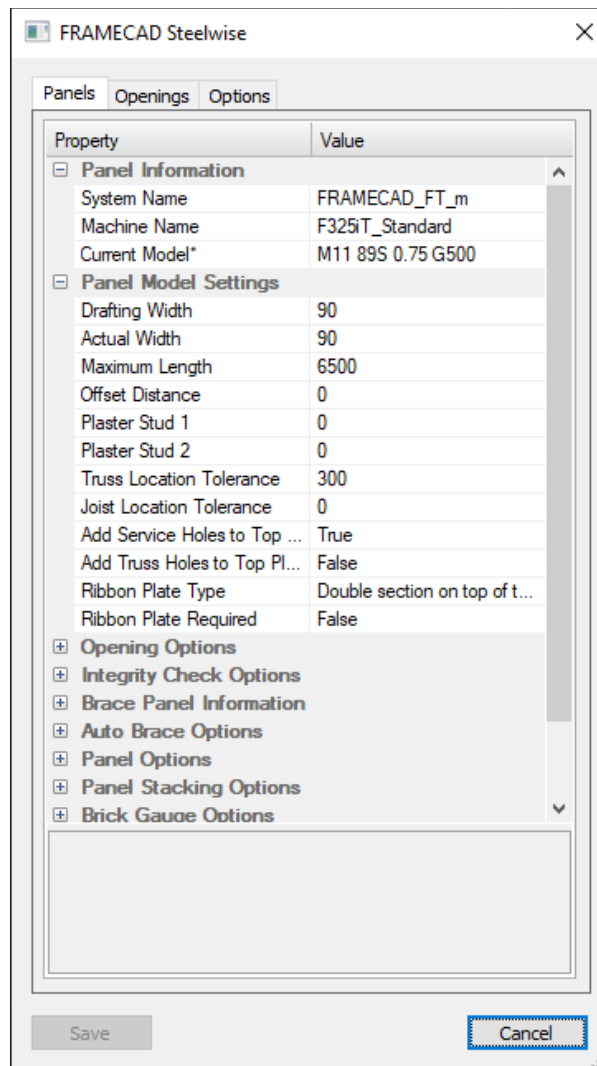

Users must select 'System Name', 'MachineName' and 'Current Model'. Default values as for the selected model are filled from the system Data file and/or previous user input. Users may modify values in any active field.

Smart Floor/Ceiling/Roof Panel settings are found in the 'Options' tab.

2.3.3 Truss Settings (TSET)

Sets Roof Truss Framing System and Layout Form (Layout Options) plus a wide range of loading and geometry parameters

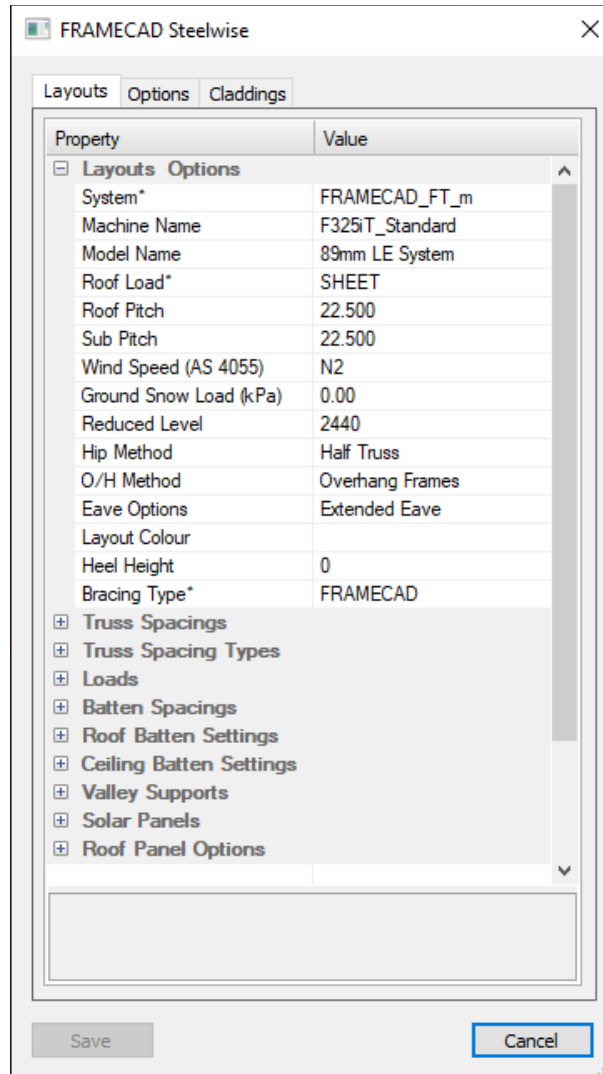

| Property | Value |
|--|-----------------|
| <input type="checkbox"/> Layouts Options | |
| System* | FRAMECAD_FT_m |
| Machine Name | F325iT_Standard |
| Model Name | 89mm LE System |
| Roof Load* | SHEET |
| Roof Pitch | 22.500 |
| Sub Pitch | 22.500 |
| Wind Speed (AS 4055) | N2 |
| Ground Snow Load (kPa) | 0.00 |
| Reduced Level | 2440 |
| Hip Method | Half Truss |
| O/H Method | Overhang Frames |
| Eave Options | Extended Eave |
| Layout Colour | |
| Heel Height | 0 |
| Bracing Type* | FRAMECAD |
| <input type="checkbox"/> Truss Spacings | |
| <input type="checkbox"/> Truss Spacing Types | |
| <input type="checkbox"/> Loads | |
| <input type="checkbox"/> Batten Spacings | |
| <input type="checkbox"/> Roof Batten Settings | |
| <input type="checkbox"/> Ceiling Batten Settings | |
| <input type="checkbox"/> Valley Supports | |
| <input type="checkbox"/> Solar Panels | |
| <input type="checkbox"/> Roof Panel Options | |

2.3.4 Joist Settings (JSET)

Sets Floor Joist Framing System (Member Information) plus a wide range of loading and geometry parameters

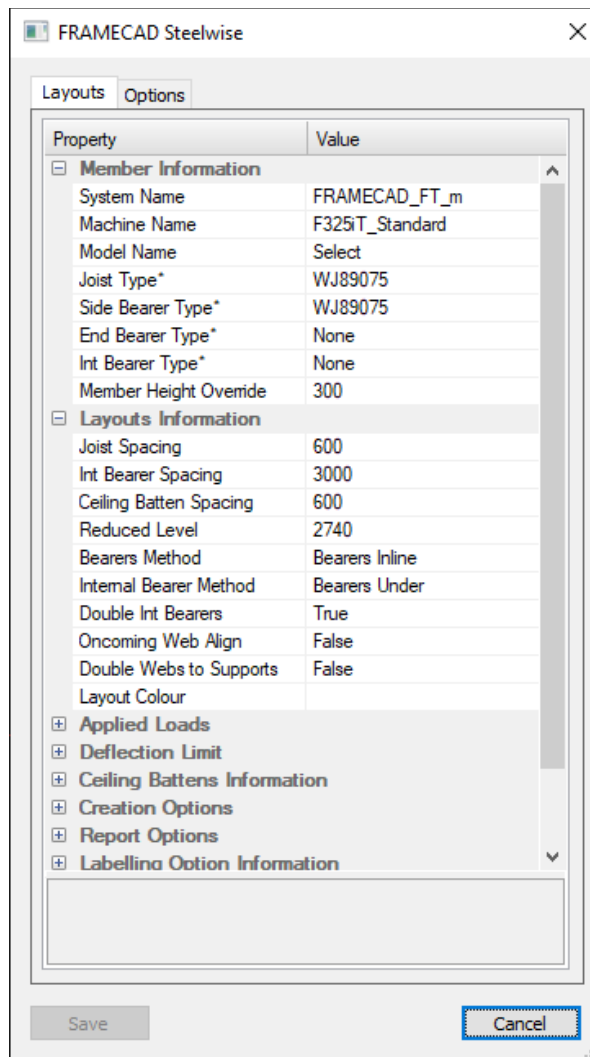

| Property | Value |
|-------------------------------------|----------------|
| Member Information | |
| System Name | FRAMECAD_FT_m |
| Machine Name | F325T_Standard |
| Model Name | Select |
| Joist Type* | WJ89075 |
| Side Bearer Type* | WJ89075 |
| End Bearer Type* | None |
| Int Bearer Type* | None |
| Member Height Override | 300 |
| Layouts Information | |
| Joist Spacing | 600 |
| Int Bearer Spacing | 3000 |
| Ceiling Batten Spacing | 600 |
| Reduced Level | 2740 |
| Bearers Method | Bearers Inline |
| Internal Bearer Method | Bearers Under |
| Double Int Bearers | True |
| Oncoming Web Align | False |
| Double Webs to Supports | False |
| Layout Colour | |
| Applied Loads | |
| Deflection Limit | |
| Ceiling Battens Information | |
| Creation Options | |
| Report Options | |
| Labelling Option Information | |

2.4 Framing Model Objects

The FRAMECAD Steelwise is built up from a series of Objects (CAD drawing entities programmed with a series of framing properties). Following is an overview of the Steelwise model objects.

2.4.1 Layouts Space Objects

A building model in a layout border is drawn as a series of 2D objects representing the plan view of the structural framing components (e.g. CFS Wall Panels, CFS Trusses). The framing objects are either drawn in the layout using CAD type drawing commands (select start and end point for the frame, or convert a drawn line to frame object) or are automatically generated using layout setout commands. The width of the frame object is automatically generated from the System settings.

The Layouts Space objects are assembled into a building model by assigning spatial location parameters to the objects.

- Vertical (or elevation) location in the building model is determined by the objects Reduced Level (RL) - This is set in the Settings forms, and may be amended for individual objects in the List Item (LI) forms.

- Horizontal (or plan) location in the building model is determined by the location of the object relative to the drawing border Reference Point. A Reference Point is added to a border using the Reference Point Input (**REF**) Command. If no reference point is present in the border, then the building objects in the border will not be related to those in the other borders

Layouts objects are assembled into a building model for the following purposes:

- Loads calculated for Wall Engineering and force output will include loads from referenced Floors, Roof and other Wall Levels
- Wall Frame Detailing considers referenced Floor and Roof objects (e.g. alignment of studs under trusses where specified).
- The 3D model produced in Model Space shows that it is spatially accurate.

Layout Models

Panels/Walls

Panel (Wall) Layouts utilise the following CFS framing object types which can be engineered and detailed for CNC output:

- Panels (Wall Frames; Load Bearing, Structural, & Non Load Bearing)
- Openings (Doors and Windows)

Panel (Wall) Layouts utilise the following CFS framing object types which can be detailed for CNC output but are not engineered:

- Beams (2 types; Deep C sections & Webbed frame sections)
- Ceiling Panels (Ceiling or Roof Frames)

Panel (Wall) Layouts also utilise the following types of general structural objects (typically Structural Steel) which are added to the layouts so that the CFS framing objects are detailed to fit around these other structural components. They are not engineered or detailed.

- Beams
- Posts

Individual walls are usually generated using the Panel Draw (**PD**) or Add (**A**) command, and then breaking the walls into manageable size panels using the member editing commands.

Tip: Architectural wall layouts can be imported/inserted into layout drawings to provide a template for quick panel drawing.

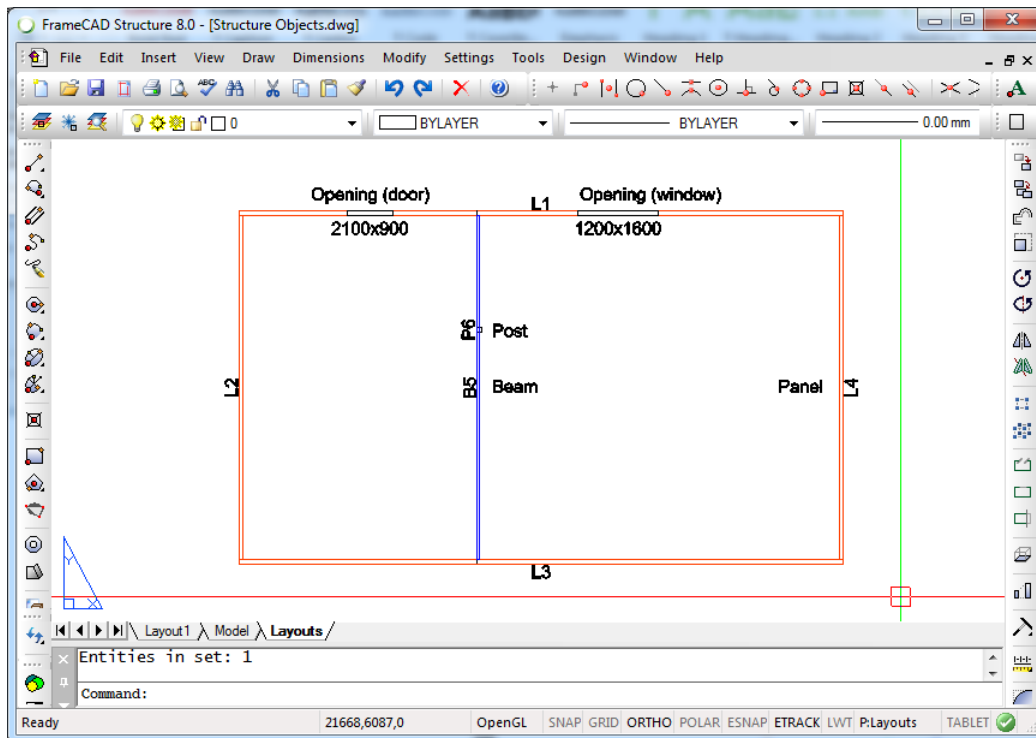

Panel Layouts can also include two Member Objects which are part of the detailed Wall Panel Frames (refer to Detailing Space Objects)

- Stud Members
- Brace Members

Stud Members are automatically generated in wall frames after the walls have been built (**PPD**), or can be manually generated using the Build Studs (**PBS**) or Update Engineering (**PUA**), or added using the Stud Array (**PSA**) command.

Brace Members are manually added using the Panel Insert Brace (**PIB**) command.

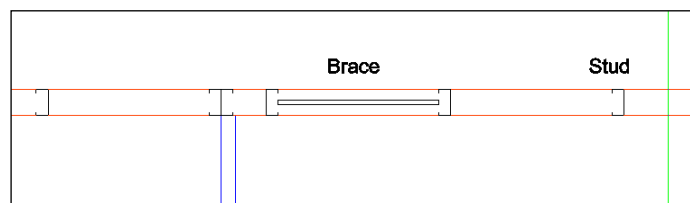

Roof Truss

Roof Layouts utilise 1 CFS framing object type. These objects can be engineered and detailed for CNC output:

- Truss (Truss, Rafter, & Gable Frames)

Blocks of individual trusses are usually auto generated using the Truss Draw (**TD**) command on a wall framing outline coded as Support Lines (SL). Hip, valley and ridge lines are generated using the Create Roof Lines command (**CRL**) on a roof outline coded as Roof Line (RL).

Roof Truss layouts generally utilise non-structural line objects used for Roof truss model generation

- Roof Line – Roof outlines used as guides to define geometry of trusses
- Support Line – Line representing roof support structure used to determine truss support locations

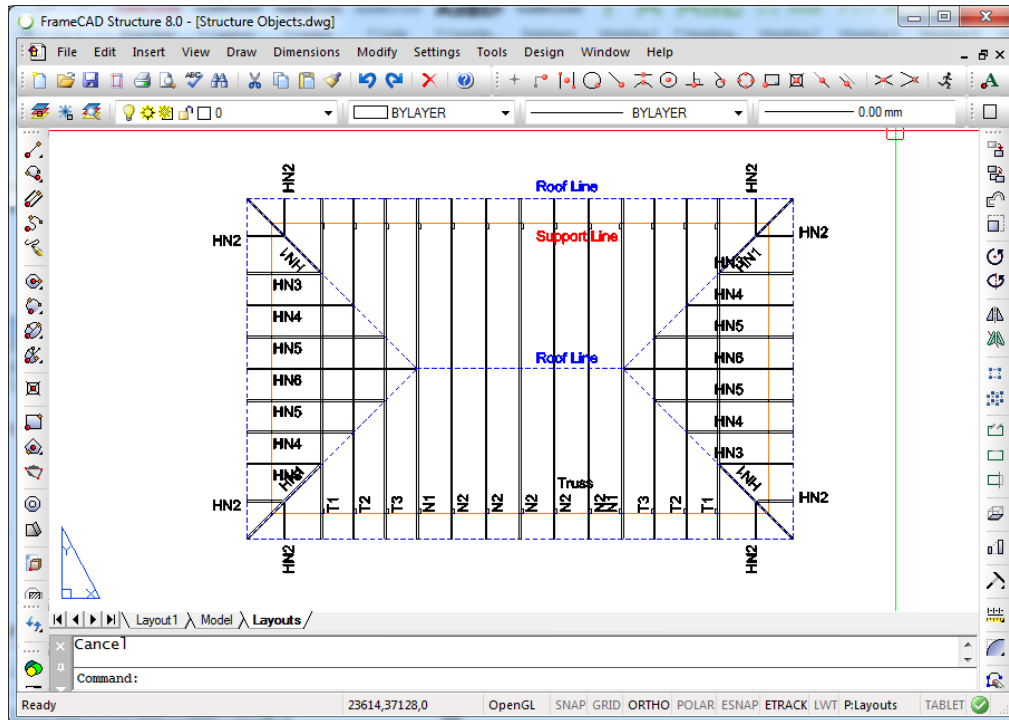

Floor Joists

Joist Layouts utilise 1 CFS framing object type. These objects can be engineered and detailed for CNC output:

- Joists (Deep C Sections and Webbed Sections)

Blocks of individual joists are usually auto generated using the Joist Draw (**JD**) command.

Floor Joist layouts also utilise non-structural line objects used for floor joist model generation

- Support Line – Line representing floor support structure used to determine joist support locations.

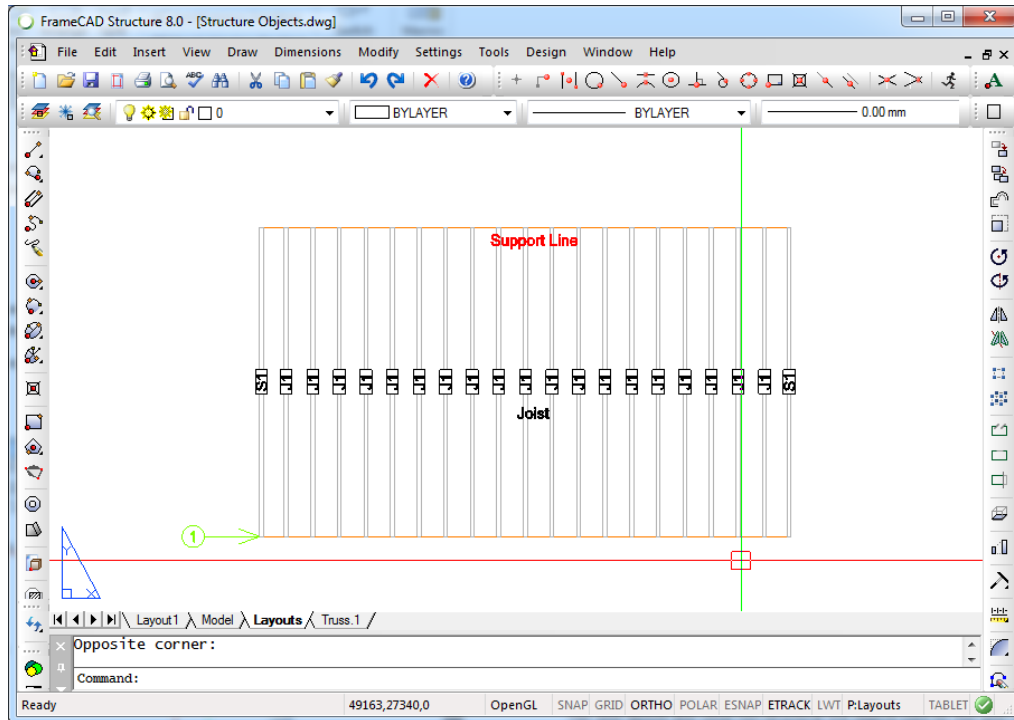

Object Properties and Editing

The properties of the layout objects may be viewed and edited using the List Item command (**LI**). This command will bring up an object dependant property form for the selected items. If multiple objects are selected, the **LI** form type will be populated as applicable for the first object in the selection. The LI command can be used to modify properties of multiple items of the same object type.

Tip: To edit multiple items select one of the items individually, and then use a window select for the other objects (items which are not the same object type as the initial item will be ignored).

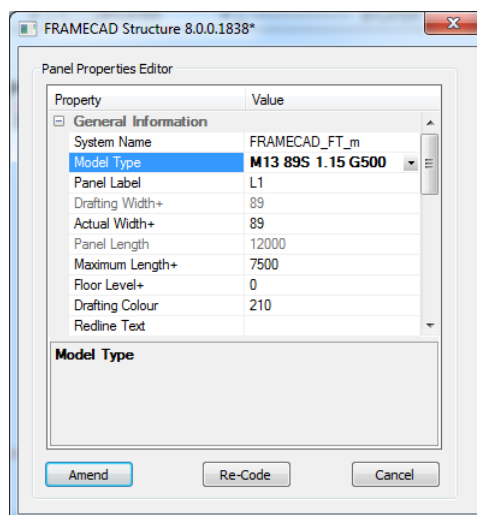

2.4.2 Detail Space Objects

Each Detail space border contains the fabrication model for an individual framing object. The framing model is drawn as a series of 2D objects representing the elevation view of the component CFS framing sections (eg. Truss Cord and Web Members, Wall Plate and Stud Members). The member objects are typically auto generated by the Frame Builder functions. Additionally there is some

provision to add or edit component members in the Detailing view using CAD type drawing commands.

Panels

Panel Details utilise 1 CFS framing object type for CNC output:

- CFS Member (Plate, Stud, Nog, Brace, Head, Head Web, Sill)

Panel Details also include 2 additional CFS framing object types for BOM only:

- Strap Brace
- Header Plate

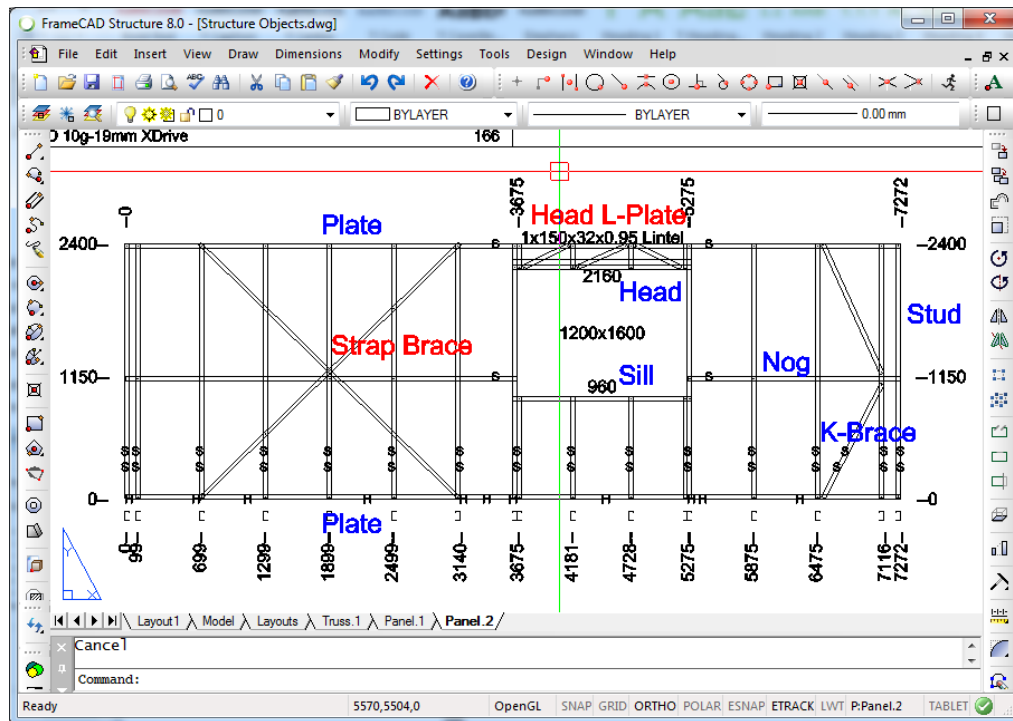

Trusses

Truss Details utilise 1 CFS framing object type for CNC output:

- CFS Member (Top Chord, Bottom Chord, Horizontal Chord, Rail, Web)

Truss Detail Drawings also utilise non-structural line objects used for Roof truss model generation

- Point load – Point representing user added point loads (uniform loads are auto generated)
- Support Point – Point representing support locations

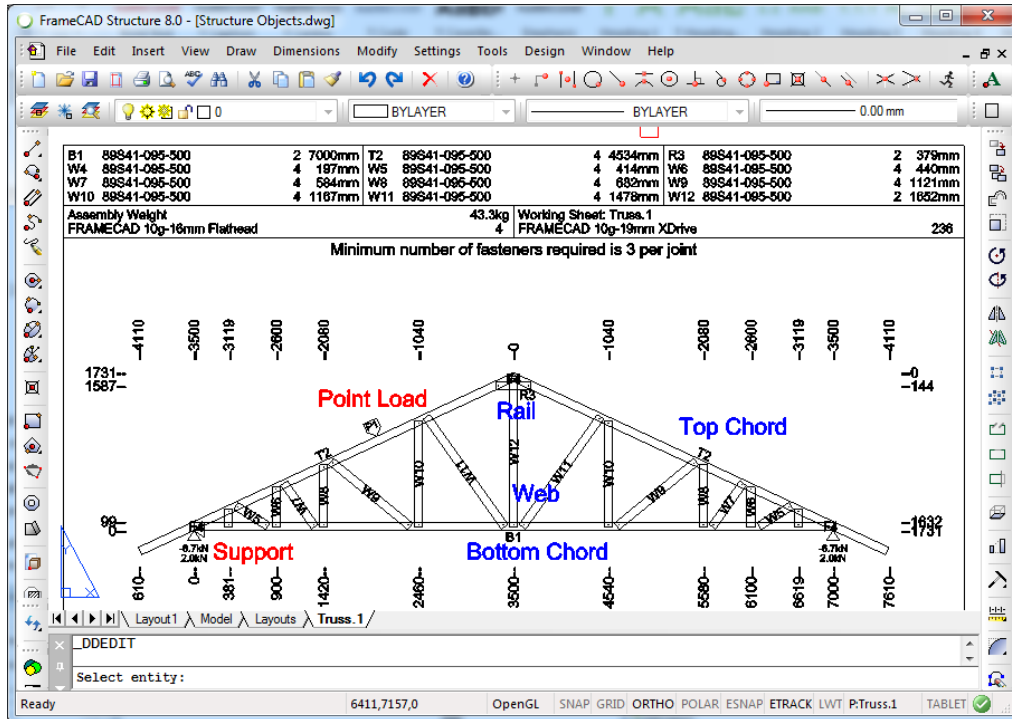

Joists

Joist Details utilise 2 CFS framing object types for CNC output:

- Webbed Joists CFS Member (Top Chord, Bottom Chord, Web)
- Deep C Joist Member

Joist Detail Drawings also utilise non-structural line objects used for Roof truss model generation

- Support Point – Point representing support locations

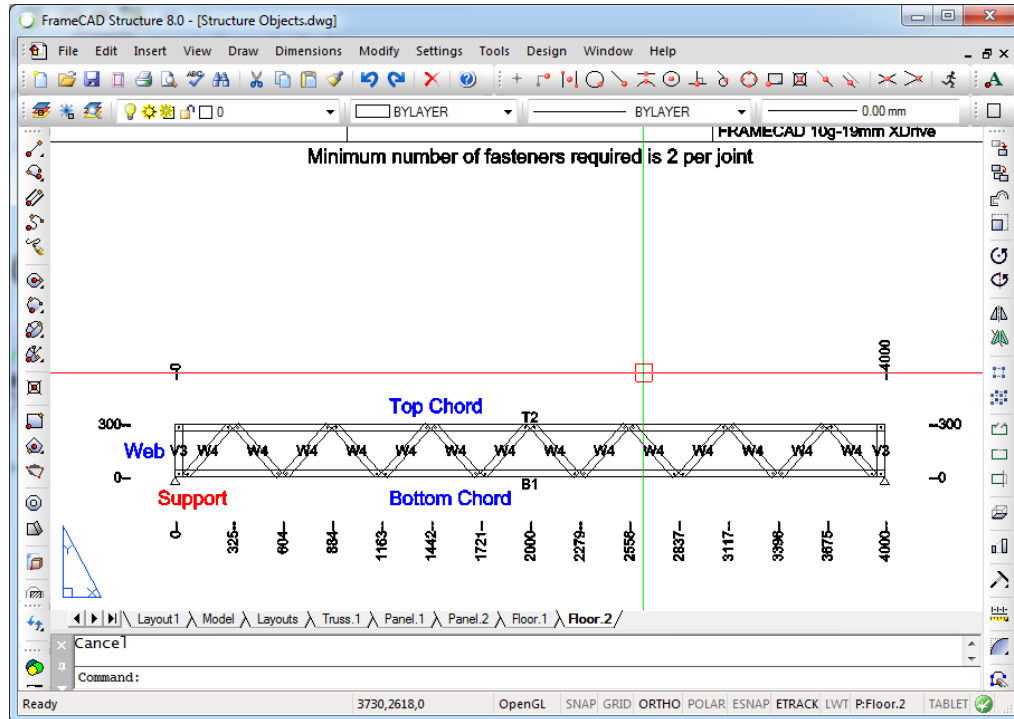

Special Objects

All detail sheet models can also contain a number of other objects required for design or detailing

- Fixing Details – Auto generated member to member connections with design parameters (e.g. screw type and number, joint load)
- Special Tooling – User Specified Tooling Operations (e.g. Service Holes); generated according to frame system settings, or manually added using the Explicit Tools (**ET**) command.

Detailing Object Properties and Editing

The properties of the layout objects may be viewed and edited using the List Item command (LI). This command will bring up an object dependant property form for the selected items.

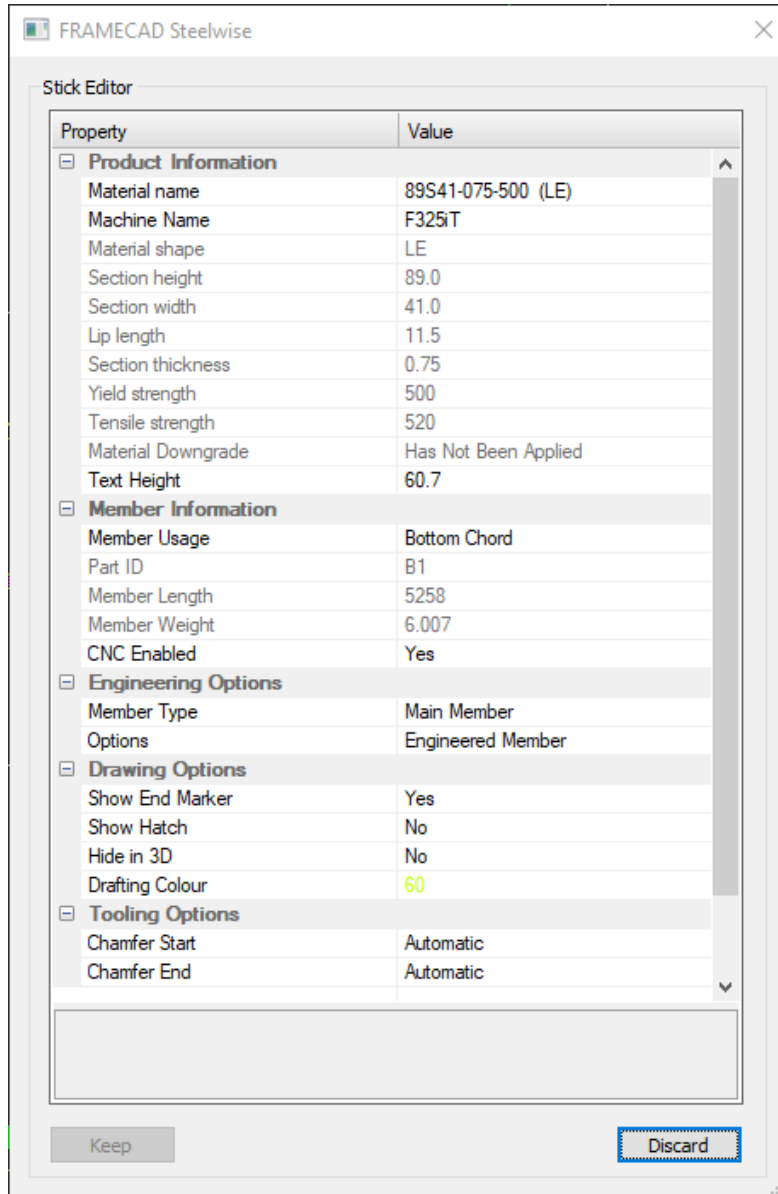

The screenshot shows the 'Stick Editor' dialog box in FRAMECAD Steelwise. It contains a table with two columns: 'Property' and 'Value'. The properties are grouped into several categories, each with a collapse/expand icon (a square with a minus sign). The categories and their values are as follows:

| Property | Value |
|----------------------------|----------------------|
| Product Information | |
| Material name | 89S41-075-500 (LE) |
| Machine Name | F325T |
| Material shape | LE |
| Section height | 89.0 |
| Section width | 41.0 |
| Lip length | 11.5 |
| Section thickness | 0.75 |
| Yield strength | 500 |
| Tensile strength | 520 |
| Material Downgrade | Has Not Been Applied |
| Text Height | 60.7 |
| Member Information | |
| Member Usage | Bottom Chord |
| Part ID | B1 |
| Member Length | 5258 |
| Member Weight | 6.007 |
| CNC Enabled | Yes |
| Engineering Options | |
| Member Type | Main Member |
| Options | Engineered Member |
| Drawing Options | |
| Show End Marker | Yes |
| Show Hatch | No |
| Hide in 3D | No |
| Drafting Colour | 60 |
| Tooling Options | |
| Chamfer Start | Automatic |
| Chamfer End | Automatic |

At the bottom of the dialog box, there are two buttons: 'Keep' and 'Discard'.

2.5 Framing Functions and Outputs

A number of Framing operations are available for each Model space and type. Following is a summary of the principal functions. For a detailed list of operations refer the 'Detailed Procedures' and 'Menu and Commands' sections.

2.5.1 Layouts Space

General Functions

Creating (Drawings) Framings Objects:

Framing objects such as Wall Panels Trusses, etc, can be input using the **ADD** command (ribbon button).

Choose the object type and parameters, and then select 'Create' to enter drawing input mode.

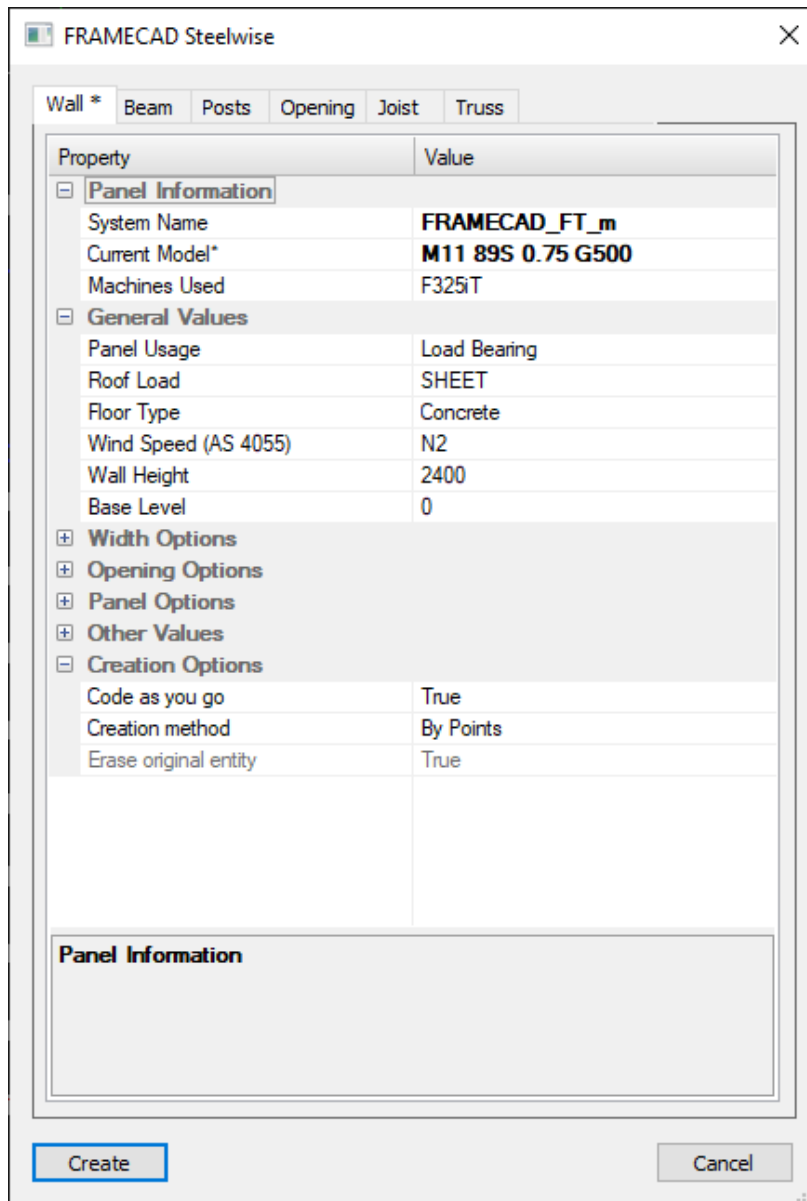

| Property | Value |
|--------------------------|-------------------|
| Panel Information | |
| System Name | FRAMECAD_FT_m |
| Current Model* | M11 89S 0.75 G500 |
| Machines Used | F325iT |
| General Values | |
| Panel Usage | Load Bearing |
| Roof Load | SHEET |
| Floor Type | Concrete |
| Wind Speed (AS 4055) | N2 |
| Wall Height | 2400 |
| Base Level | 0 |
| Width Options | |
| Opening Options | |
| Panel Options | |
| Other Values | |
| Creation Options | |
| Code as you go | True |
| Creation method | By Points |
| Erase original entity | True |

Panel Information

Create Cancel

Additional object input commands are available for individual object types. Refer to 'Basic Procedures' and 'Commands' sections of this manual for details.

Editing Framings Objects:

Cutomised CAD commands are provided for editing framing objects. Eg. Trim, Lengthen, Reverse, Join, ...

Refer to 'Basic Procedures' and 'Commands' sections of this manual for details.

Generate and Output Layout Reports: Report (**REP**) - Report a range of model properties (Framing Construction Accessories, Engineering Summary Outputs, Cladding Geometric parameters). Outputs vary for each sub-assembly type (Walls, Roof, Floor).

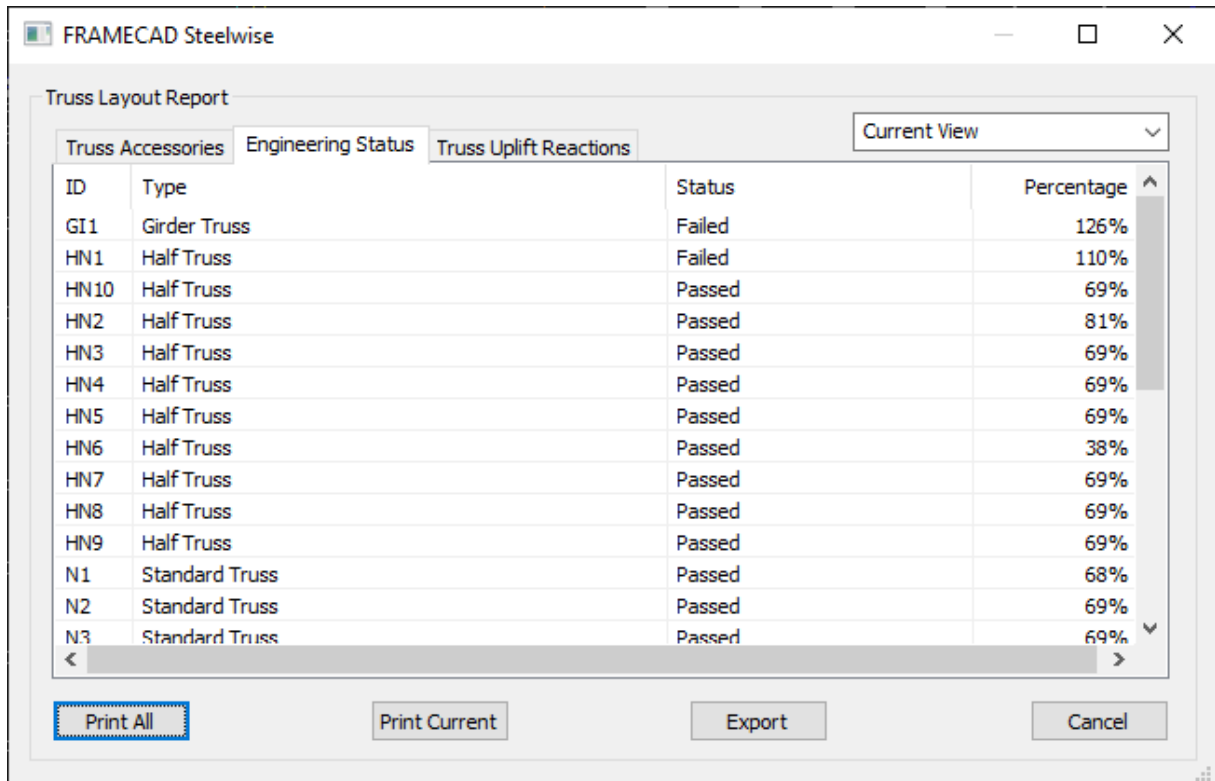

The screenshot shows the 'FRAMECAD Steelwise' application window with the 'Truss Layout Report' dialog box open. The dialog has three tabs: 'Truss Accessories', 'Engineering Status', and 'Truss Uplift Reactions'. The 'Engineering Status' tab is selected. A 'Current View' dropdown menu is visible in the top right. The main area contains a table with the following data:

| ID | Type | Status | Percentage |
|------|----------------|--------|------------|
| GI1 | Girder Truss | Failed | 126% |
| HN1 | Half Truss | Failed | 110% |
| HN10 | Half Truss | Passed | 69% |
| HN2 | Half Truss | Passed | 81% |
| HN3 | Half Truss | Passed | 69% |
| HN4 | Half Truss | Passed | 69% |
| HN5 | Half Truss | Passed | 69% |
| HN6 | Half Truss | Passed | 38% |
| HN7 | Half Truss | Passed | 69% |
| HN8 | Half Truss | Passed | 69% |
| HN9 | Half Truss | Passed | 69% |
| N1 | Standard Truss | Passed | 68% |
| N2 | Standard Truss | Passed | 69% |
| N3 | Standard Truss | Passed | 69% |

At the bottom of the dialog, there are four buttons: 'Print All', 'Print Current', 'Export', and 'Cancel'. The 'Print All' button is highlighted with a blue dashed border.

Print/Export Layout Drawings:

- Spool Print (**SP**) – Print selected drawing borders to a physical printer or installed pdf printer

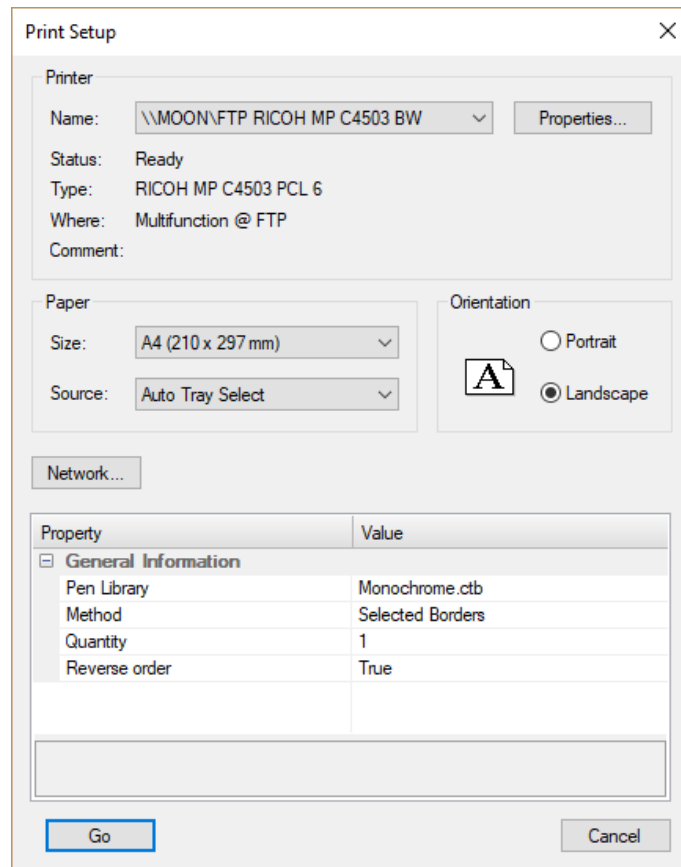

- PDF – Export a pdf file which includes the selected layout views

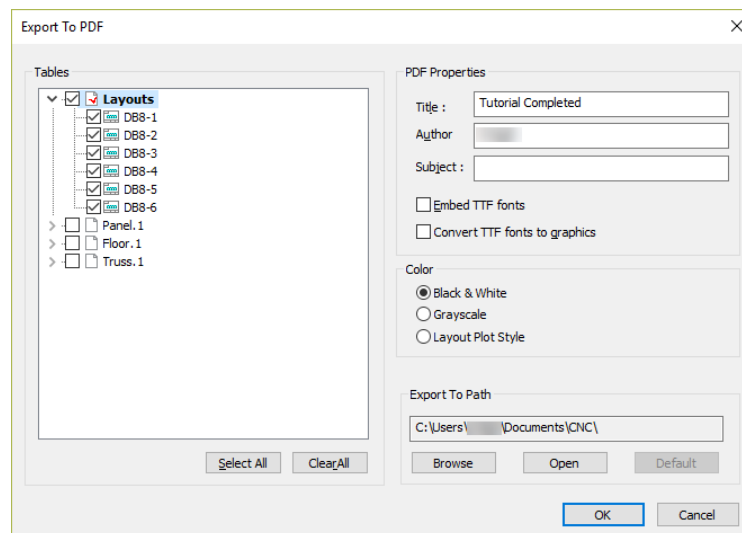

Walls

Engineering and Building Wall Panels

Framing details of a wall panel object are generated by the software for a combination of Framing System settings (System Data file), User Input (PSET & LI), and Engineering calculations.

- Top Plates, Bottom Plates, and Nogs are generated based on the system setting and input.
- Bracing is generated as per user input on the drawing
- Wall Studs are generated based on the system setting and input, plus Engineering Calculations, which will generate additional Studs where required for the system loading.
- Header Members are generated based on the system setting and input, plus Engineering Calculations, which will generate L-plate reinforcing member or additional screws where required for the system loading.

Layout Panel Engineering and Build Control

This 'Building' of a wall panel in layout space may be done in layout space, dependant on project setting and user commands.

User Commands

Panel Update All (PUA) - select "Update Wall Engineering" on the Steelwise Ribbon Menu.

- Updates Building loads, Runs Stud and Opening Design, Builds all studs and regenerates all studs in layout drawing

Panel Build Studs (PBS) - select "Build Wall Studs" on the Steelwise Ribbon Menu.

- Builds all studs and regenerates all studs in layout drawing (based on previous Engineering loads or calculations where applicable)

Automatic Panel Build Operations:

Panel Stud arrangement reset to 'Auto' (**LI**) or Panel Stud Spacing Altered (**LI**)

- Runs Stud Design based on existing loads, builds all studs and regenerates all studs in layout drawing

Panel Stud arrangement changed

- Builds all studs and regenerates all studs in layout drawing

Panel Insert Brace (**PIB**) command

- If changes since previous build are detected- Builds all studs and regenerates all studs in layout drawing prior to brace insert

Wall Stud Engineering operations carried out by Steelwise:

Loading Calculation

Loading of wall panels is calculated using a tributary load takedown procedure.

- Roof truss and floor joist load is distributed to directly supporting walls based on tributary loading span. Load Bearing Wall, Structural Walls, and Beams are considered as supporting structure (NOTE: No design is carried out for beam objects).
- Additionally users may specify an extra truss or joist span on individual panels (**LI**) for cases where roof or floor members are not explicitly modelled – NOTE: Tributary loaded width applied to wall is one-half of the extra span.

- Load from an upper wall panel is transferred to parallel wall panels directly below, provided that the top of the panel is within a specified 'Structural Tolerance' of the base of the upper panel (default is 800mm) – user modify using **(LI)**.
- Unless otherwise noted all loading is applied as equivalent uniform load over the full length of the panel – Designers and Engineers are to ensure that these assumptions are valid for construction where applicable.
- Panels are considered as continuously supported – Designers and Engineers are to ensure that these conditions are met for construction.

Note: Calculated loads are shown in member listing **(LI)**

Uniform Loading Panel Stud Design:

Calculates the allowable maximum stud spacing for the selected framing material, considering uniform loading:

- 'Load bearing' & 'Structural' panels designed for vertical loading plus face wind loading
- 'Non Load Bearing' panels designed for face wind loading only
- Calculated stud spacing reported in the Panel data as the "Nominal Stud Spacing".
- Actual Stud Spacing is set as the minimum of the Nominal Stud Spacing and the default stud spacing for the model (typically 600mm / 24").

Concentrated Loading Panel Stud Design:

Calculates requirements for additional studs for specific cases of concentrated loading:-

- Wall panel directly supporting girder trusses, trusses with spacing > 610mm, beam bearers, & joist beams supporting other joists (NOTE: for lower walls, load is considered as distributed as per NASH guidelines) – 'Load bearing' panels type only
- Opening Jamb loads (checked on all wall panels below jamb) – 'Load bearing' panel types only
- Bracing Collector Stud loads (checked on all wall panels below jamb) – Rigid Diaphragm Bracing design only - 'Load bearing' & 'Structural' panels

Users may override Engineering provisions for stud placement via the Panel Engineering option in **BSET**, or by over writing the studs placement results in the panel properties **(LI)**

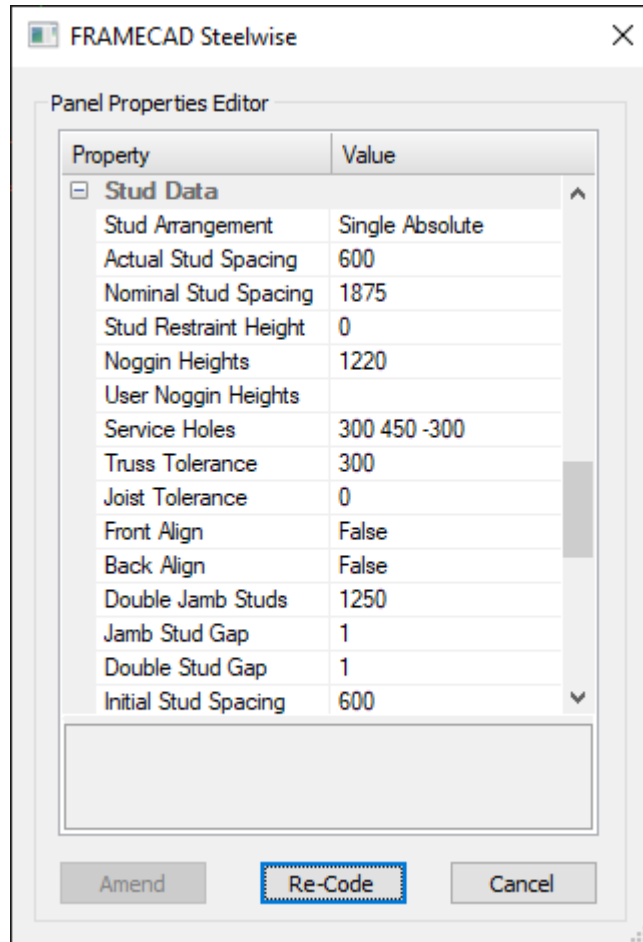

Openings Engineering operations carried out by Steelwise:

Uniform Loading Design: - 'Structural' panel type only

Performs a design check of the Opening Header and Jamb for the selected System and Material, considering uniform loading on the Header – will generate L-plate reinforcing member for Webbed Heads and additional Studs for jambs where required.

- Uniform loads from panels above, and all directly supported trusses and joists including girders, converted to an equivalent uniform load. Adjusted for openings above if they cover the full width of the opening being designed (will decrease header loads accordingly rather than consider full panel load)

Non-Uniform Loading Design: - 'Load Bearing' panel type only

Performs a design check of the Opening Header and Jamb for the selected System and Material, considering combination of uniform loading and concentrated loading on the Header – will generate L-plate reinforcing member for Webbed Heads and additional Studs for jambs where required.

- Design action analysis models point loads from Jamb studs in panels above, and directly supported girder trusses, trusses with spacing > 610mm or 20% of the opening length, & joist/bearer beams
- Uniform loads from panels above, and directly supported trusses and joists not which are not considered as point loads. Adjusted for openings above (will decrease header loads accordingly rather than consider full panel load)

NOTE: Openings are not designed for loads from brace chord studs (but software will still consider the bracing in the lateral analysis) – therefore bracing should not be modelled over openings.

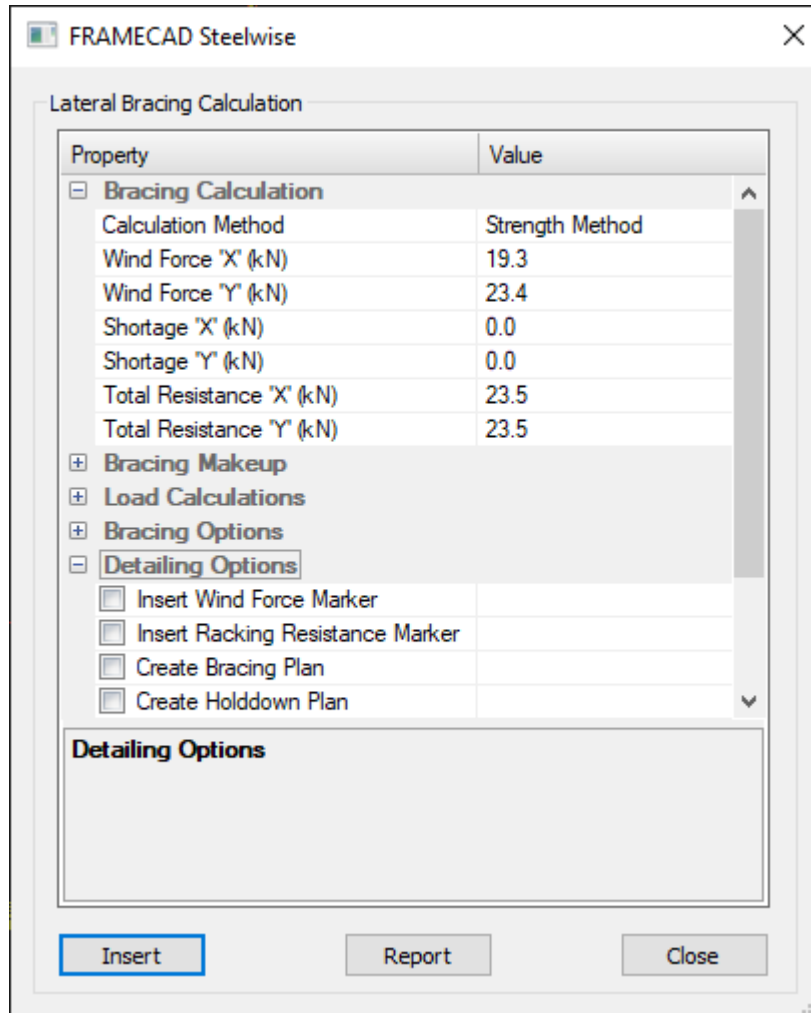
Bracing Design & Report & Drawings Generation: Panel Calculate Bracing (PCB)

Calculations and Output dependant on Bracing Design Method
Strength Method

- Standard Steelwise wall bracing method with software limitations as outlined in section 2.2 of the Engineering Guide.
- Calculates the strength of the braces modelled and checks their combined strength against the total building Wind and Earthquake loads.
- Provides check of Bracing distribution to NASH standard

Rigid Diaphragm Method (option only applicable to IBC and GB Design Codes)

- Considers floors and ceilings as rigid diaphragms in the bracing calculations, therefore lateral loads are distributed according to brace stiffness and distribution (Strap brace and Panel brace only).
- Bracing member checks and storey drift calculations and check
- Calculates Collector design actions

NOTE: When Rigid Diaphragm method is selected, Bracing Design is automatically run when panel loading calculations are updated (bracing report form will not open).

Detail and Engineer Panel with Panel Builder (PPD)

Runs Engineering Design of Members and Detailing (Building) of Panels, as per following table for selected Panel control settings in **BSET**. Display Tabs for Detailed Frame, Bill of Materials, Stud Engineering, and Detail Design Drawing

User Operations

- **Engineer All** or **Build Studs** for manual build
- **ToCad** generates Detail Space Drawings of selected wall Panels
- **Print** to output screen Tab contents

Note: PPD from wall elevations does not update engineering. Engineering is only updated when using the PPD command from the wall layout.

Roof

Layout of Roof Truss system

Trusses roof layouts are typically generated using Truss Layout Commands rather than through individual truss input.

Truss Layout (**TD**) command allows user to generate truss systems as a series of truss roof blocks. Description of this operation is provided in the manual tutorial.

Roof Shape Input (**RS**) command allows users to specify a roof shape and auto generate trusses with a single command, from a library of standard shapes.

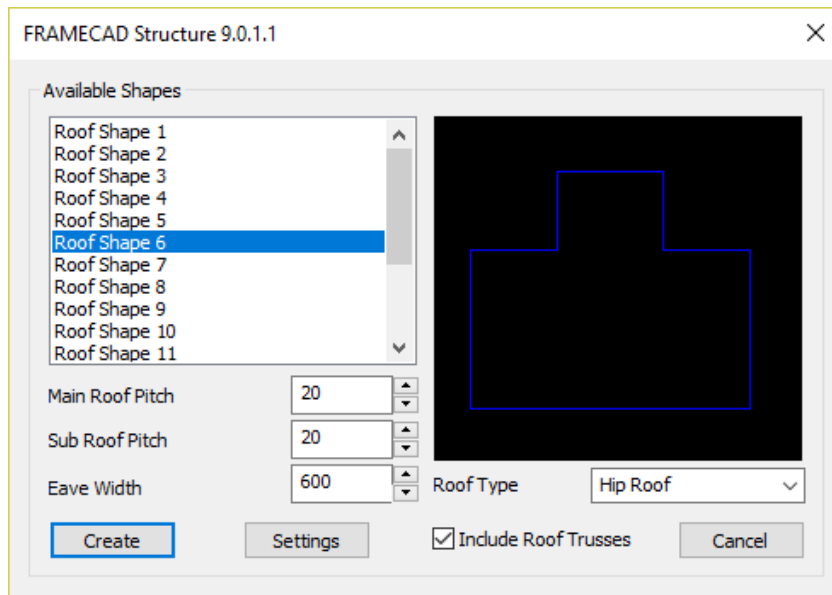

Engineering and Building Trusses

Framing details of a truss object are generated by the software for a combination of Framing System setting (System Data file), Auto generation function (TD,RS), User Input (TSET & LI), and Engineering calculations.

Trusses are not Engineered or Built directly in layouts space – this function is performed in the Truss Builder, which may be run from either Layout Space or Detail Space.

Truss Engineering operations carried out by Steelwise

Each truss frame is modelled as a 2D Frame Element finite element model generated from the centre-lines of the built truss.

Loading conditions and design codes as specified by user in Layout model. Load on each truss is determined by tributary area, calculated from the specified truss spacing, and the tributary area

("additional area") from oncoming trusses (for Girder type trusses only). Truss support points are user specified, either as support lines in layout drawing, or support points in detail drawing.

Design code strength, deflection and buckling checks are made for each element in the truss model, and software reports compliance ratio for each element, and truss as a whole (maximum of all members)

Users can modify truss frame by changing framing material, web layout, restraint conditions, or local member reinforcing to achieve required Engineering compliance.

Detail and Engineer Truss Builder (TTD)

Runs Engineering Design of Members and Detailing (Building) of Trusses. Display Tabs for Detailed Truss, Bill of Materials, Truss Engineering Diagrams, Engineering Reports, and Detail Design Drawings

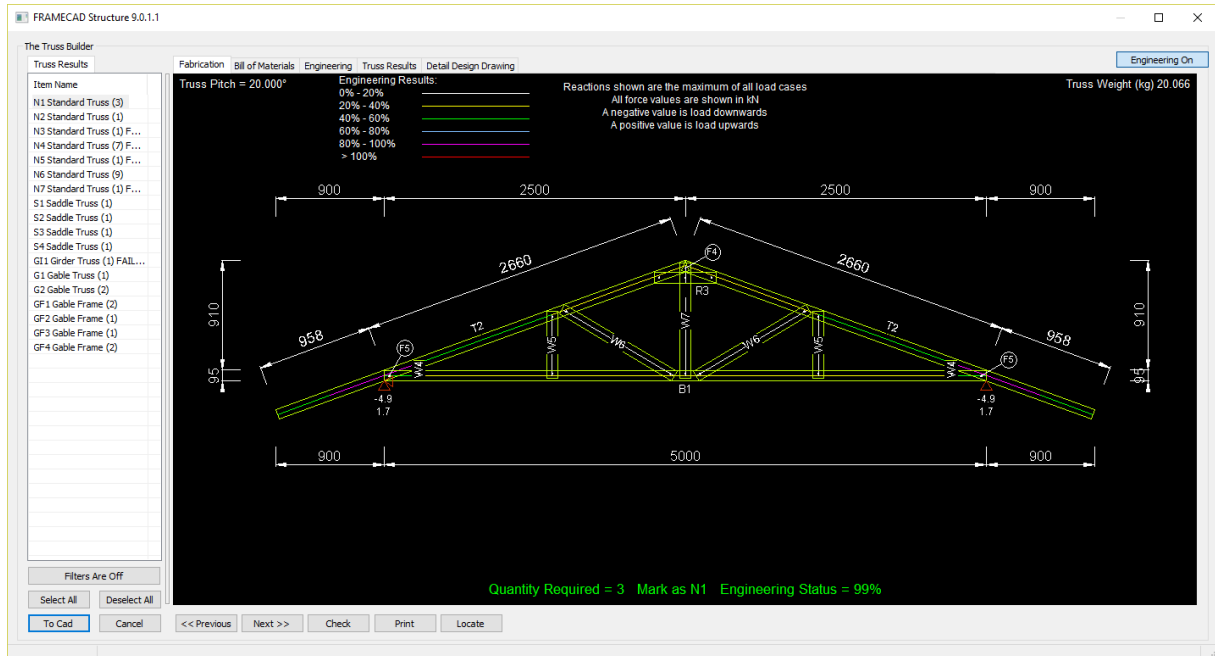

User Operations

- **ToCad** generates Detail Space Drawings of selected Trusses
- **Print** to output screen Tab contents

- Joist support points are user specified, either as support lines in layout drawing, or support points in detail drawing.

Design

- Design code strength, deflection and buckling checks are made for each element in the joist model
- Members checks are not carried out for elements within the bearing width of the modelled support
- Software reports compliance ratio for each element, and joist as a whole (maximum of all members)

Users can modify joist frame by changing framing material, web layout, restraint conditions, or local member reinforcing to achieve required Engineering compliance.

NOTE: Software does not Engineer joists to transfer load from upper wall panels to supporting walls. Designers and Engineers must specify web stiffening or additional structure as required for load bearing transfer through floor system.

Fabrication File Export (RFY)

Deep C Floor Joist Layouts may be exported directly to an RFY format file. This operation is not available for Webbed joists – these need to first be build and sent to Detail Sheet drawings prior to export.

Detail and Engineer Joist Builder (JJD)

Runs Engineering Design of Members and Detailing (Building) of Joists. Display Tabs for Detailed Joist Bill of Materials, Joist Engineering Diagrams, Engineering Reports, and Detail Design Drawings

User Operations

- **ToCad** generates Detail Space Drawings of selected Trusses
- **Print** to output screen Tab contents

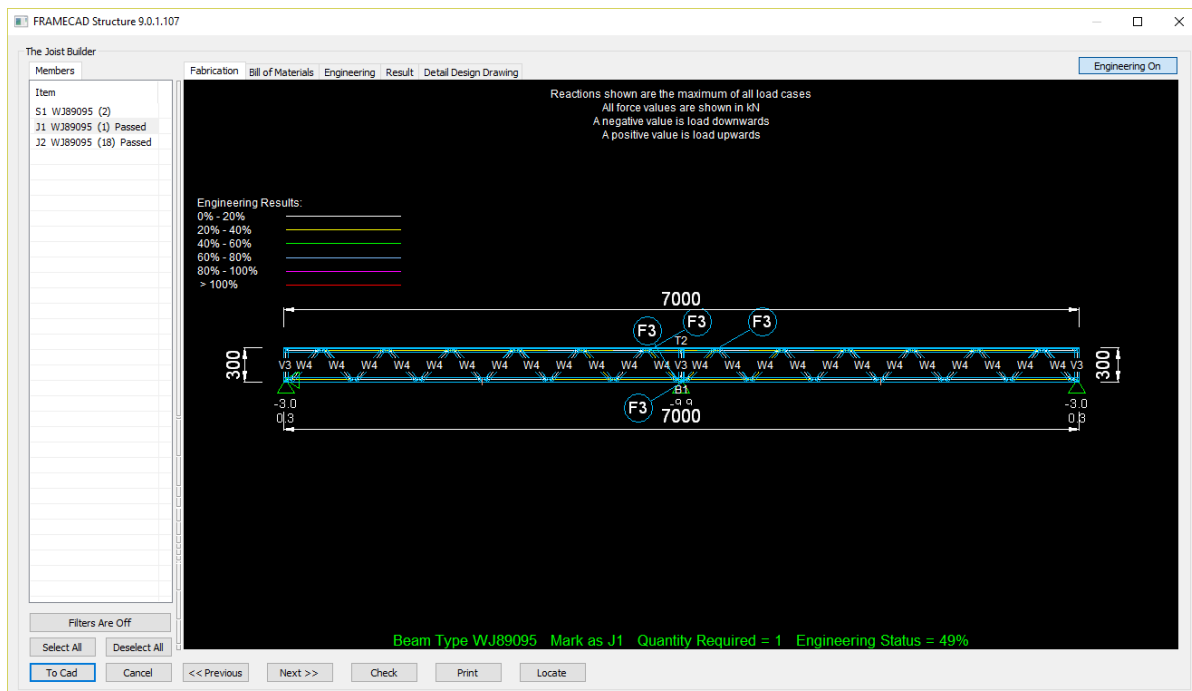

2.5.2 Detail Space

General Functions

Member Editing Operations: - A range of editing operations are available to manually refine the built frames. Refer to 'Basic Procedures' and 'Commands' sections of this manual for details.

Engineering Editing Options:- Changes can also be made non-member Engineering objects (Trusses and Joists Only)

- Engineering Supports: Add (**TAS**), Change properties (**LI**), Delete
- Point Loads: Add (**TPL**), Change properties (**LI**), Delete

Detail and Engineering Builder: PPD, TTD, JJD – Individual frames can be sent to the applicable Frame Builder form from the Detailing Sheets. This allows users to access information from the Builder for a frame which has been manually edited in the Detail Space.

NOTE: When the Frame Builder (TTD, PPD, JJD) commands are used from the Layouts space, any Detail Space frame edits are not included – this essentially allows users to rebuild from the specified Settings parameter values. If the Frames are then amended in the Frame Builder, or sent 'To Cad', any earlier models of the frame will be overwritten and the Detail Space manual edits will no longer be part of the Layouts model.

Export RFY Fabrication File: RFY – Export Detailed frames to RFY format file for fabrication.

Generate and Output Material Reports: Report (REP) - Report a range of frame material reports. Outputs vary for each frame type (Panel, Truss, Joist).

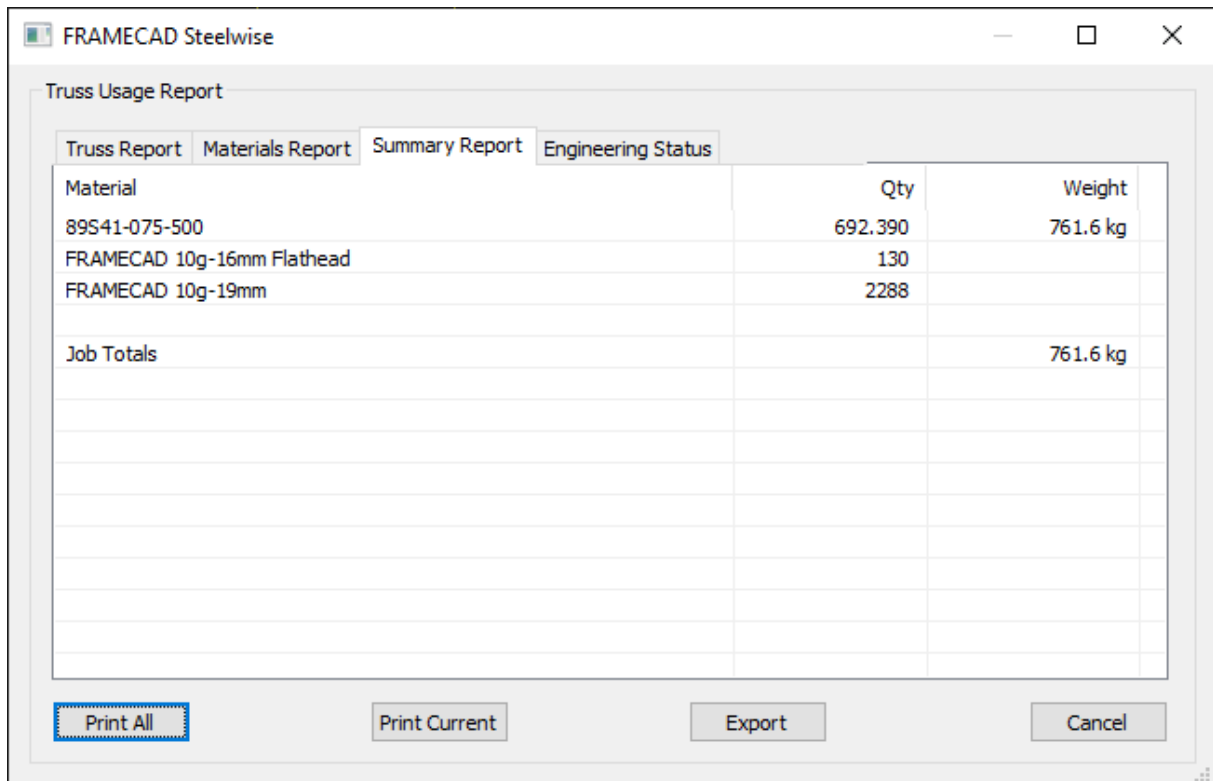

| Material | Qty | Weight |
|----------------------------|---------|-----------------|
| 89S41-075-500 | 692.390 | 761.6 kg |
| FRAMECAD 10g-16mm Flathead | 130 | |
| FRAMECAD 10g-19mm | 2288 | |
| Job Totals | | 761.6 kg |

Print/Export Detail Drawings:

- Spool Print (**SP**) – Print Selected Drawing Borders to a physical printer or installed pdf printer

Print Setup ✕

Printer

Name:

Status: Ready

Type: RICOH MP C4503 PCL 6

Where: Multifunction @ FTP

Comment:

Paper

Size:

Source:

Orientation

Portrait

Landscape

| Property | Value |
|-------------------------|------------------|
| [-] General Information | |
| Pen Library | Monochrome.ctb |
| Method | Selected Borders |
| Quantity | 1 |
| Reverse order | True |

- **PDF** – Export a pdf file which includes the selected detail elevation views

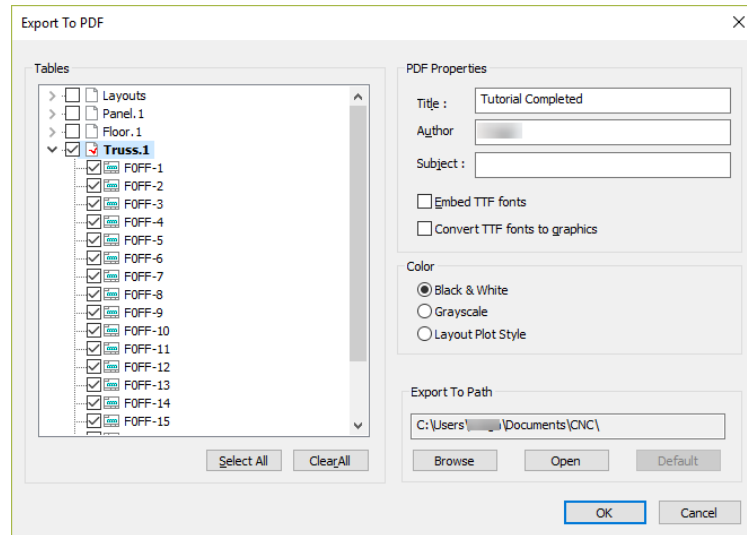

Basic Procedures

Following is the recommended procedure for generating a FRAMECAD Steelwise building model.

Important Note: Never open FRAMECAD Steelwise by double clicking on an existing job file, as certain pre-defined items will not be recognised by the program. The program must be opened first and then the existing job can be opened.

3.1 Initial Job Setup Process

- Start new layout drawing – **N** (New).

IMPORTANT NOTE: Never start a new job from an architects dwg or dxf.

- Set project information, units, and design code. Select the preferred engineering method for walls, bracing, joists and trusses as outlined in section 2.4, and insert borders as required – **BSET** (Border Settings)

NOTE: BSET is the most important step in the creation of a job and MUST be implemented before proceeding any further with this program. Failure to create BSET borders will render the job inoperable as software intelligence is imbedded into each border.

- Check truss settings – **TSET**
 - Standard Default Systems: FRAMECAD_FT_m (metric) or FRAMECAD_FT_i (imperial)
- Check wall settings – **PSET**
 - Standard Default Systems: FRAMECAD_FT_m (metric) or FRAMECAD_FT_i (imperial)
- Check floor settings – **JSET**
 - Standard Default Systems: FRAMECAD_FT_m (metric) or FRAMECAD_FT_i (imperial)

3.2 Wall Detailing Process – Stage 1

- Create building outline using the Polyline command (**P**).
- Input wall frames - **ADD** or **PD** (Panel Draw)
- Code wall frames - **LI** (List) if walls are not already coded on input.
- Edit frames:
 - **C** - Copy
 - **M** - Move
 - **MC** – Cut Member
 - **MD** – Member Divide
 - **ME** – Extend Member
 - **MF** – Fillet Members
 - **MJ** – Member Join
 - **ML** – Lengthen (or Shorten) Member
 - **MO** – Offset Member
 - **MR** – Member Reverse
 - **MJ** – Join Member
 - **MU** – Member Update

- **MX** – Cut Crossing Members
- **RF** – Reverse Frame
- Check walls - **IC** (Integrity Check)
- Dimension walls:
 - **DA** – Aligned Dimensions
 - **DH** – Horizontal Dimensions
 - **DV** – Vertical Dimensions
 - **DM** – Linear Dimensions
 - **DO** – Ordinate Dimensions
 - **DL** – Dimension Lines
- Add openings:
 - **ADD** – Opening Option
 - **UW** – User defined Window
 - **UD** – User defined Door
 - **AD** – Aluminium Door
 - **AW** – Aluminium Window
 - **AR** – Archway Opening (Square Set)
 - **CS** – Cavity Slider
 - **ED** – External Door
 - **FS** – Face Slider
 - **PA** – Passage Door
 - **R1** – Robe Door x1
 - **R2** – Robe Door x2
 - **R3** – Robe Door x3
 - **S2** – Internal Slider x2
 - **S3** – Internal Slider x3
 - **S4** – Internal Slider x4
- Insert Primary reference marker – **REF**

Refer to the Steelwise Reference Guide for more detailed information on each command. Go to the Reference Guide in the Steelwise Help dropdown menu.

A full list of commands can be found in section 5 of this manual.

3.3 Truss Detailing Process

This process is to be carried out prior to the final wall coding.

- Re-check truss settings – **TSET**
- Using the Polyline tool, draw an outline around the building on the wall framing plan then copy or move the outline to the next available blank border. Alternatively, use a roof template (**RS**). The **RS** (Roof Shape) command can be used in instance where walls are not included or for 'truss only' plans (this option is generally used for demonstration purposes).
- Offset polyline to create the eaves line.

- Code building line – **SL** (Support Line)
- Code eaves line – **RL** (Roof Line)
- Add balance of roof lines – **CRL** (Create Roof Lines)
- Detail truss blocks using the Truss Layout Input command – **TD** (Truss Draw)
- Rebuild truss eaves – **TRE** (Truss Rebuild Eaves)
- Add Solar Panels – **TS**
- Add individual trusses – **ADD**
- Edit truss layout:
 - **MB** – Shorten trusses to a line or break into two trusses.
 - **C** – Copy
 - **IP** – Inherit Properties
 - **M** – Move
 - **MO** – Offset
 - **MR** – Member Reverse
 - **SE** – Special Erase
 - **LI** – List
- View, Print or Export a csv from the Truss Layout Report – **REP** (Truss Accessories, Engineering Status and Truss Uplift Reactions).
- Dimension trusses as required – **DO, DA, DH, DV**
- Insert Secondary reference marker – **REF**
- Export to Truss Builder – **TTD**
- Check trusses using Next and Previous options or click on the Check button.
- To change a trusses properties, double click on the truss label (left column) in Truss Builder.
- 'Select All' and transfer 'To CAD' (goes to 'Truss' Detail space).
- Check all detailed trusses as required – **VR** (Initial View) & **VV** (Next View)
- Check engineering and amend trusses as required – **TTD** (double click on the truss name to edit parameters or update engineering)
- Edit truss elevations:
 - **ADD** – Add chords, webs or rails
 - **AS** – Add Support
 - **BM** – Box Member
 - **CM** – Code Member
 - **IW** – Insert Web
 - **MI** – Mirror Web
 - **MU** – Member Update (also resolves missing fasteners)
 - **TPL** – Truss Point Load
- View, Print or Export a csv from the Truss Usage Report – **REP** (Various material summary reports and Engineering Status).
- Create RFY file – **RFY**
- Go back to 'Layouts' space

- Add truss accessories report to plan – **TOA**
- Add truss uplift plan – **TUP**
- Go to second stage of wall panel detailing or floor joist detailing now that the truss loads can be transferred.

3.4 Floor Joist Detailing Process

- Re-check floor joist settings – **JSET**
- Create floor outline – **P** (Polyline), or copy outline from wall layout.
- Create support lines from wall layout – **CSL** (Create Support Line)
- List and edit support line widths and alignment type.
- Input floor joists – **JD** (Joist Draw)
- Add individual joists – **ADD**
- Edit joists:
 - **MB** – Shorten joists to a line or break a joists into two.
 - **C** – Copy
 - **M** – Move
 - **MO** – Offset
 - **ME** – Member Extend/Trim
 - **LI** – List
- List and edit joist usage.
- View, Print or Export a csv from the Floor Layout Report – **REP** (options included are Member, Sheet, Batten and Accessories Reports).
- Insert Secondary reference marker – **REF**
- Export to the Joist Builder – **JJD** (If deep C joists are being detailed go straight to **RFY** to create RFY file)
- Check joists using Next and Previous options or click on the Check button.
- To change a joists properties, double click on the joist label in the Joist Builder.
- 'Select All' and transfer 'To CAD' (goes to 'Joist' Detail space)
- Check all detailed joists as required - VR (Initial View) & VV (Next View)
- View, Print or Export a csv from the Floor Usage Report – **REP**
- Create RFY file – **RFY**
- Go back to 'Layouts' space
- Add joist accessories report to plan if required – **JOA**
- Dimension joists as required – **DO, DA, DH, DV**
- Go to second stage of wall panel detailing now that the joist loads can be transferred.

3.5 Wall Detailing Process – Stage 2

Note: Make sure truss and floor layouts have been completed before proceeding with this stage of the Wall Detailing Process as roof and floor loads must be applied to the walls (see Truss Detailing Process and Floor Joist Detailing Process).

Note: Bracing should not be inserted until the 'Reference Markers' are in place. This is because for the bracing calculations to be accurate, the applied loads must all be known.

- Make any changes to frames then amend – **LI**
- Break walls to suit loads from above and required length – **MC**
- Build wall studs – **PBS**
- Update wall engineering/loads and rebuild loadbearing wall components – **PUA**
- Check bracing if required – **PCB**
- Add bracing to wall frames – **PIB**
- Label all walls and beams – **LA**
- Check walls – **IC**
- Add on-page reports as required:
 - **OR** – Design Report
 - **POS** – Panel Summary
 - **POB** – Beam Summary
 - **POO** – Opening Summary
 - **POP** – Post Summary
 - **POA** – Accessory Report
- Create bracing plan if required – **PCB**
- View, Print or Export a csv file from the Panel Layout Report – **REP**. Options include Openings, Reactions, Loads, Accessories and Statistics reports (Statistics report includes bottom plate lengths, wall surface square areas, wall perimeters and hold down quantities).
- Export to Wall Builder – **PPD**
- Check panels using Next and Previous options or click on the Check button.
- 'Select All' and transfer 'To CAD' (goes to 'Panel' Detail space).
- Double check all detailed wall panels as required – **VR** (Initial View) & **VV** (Next View)
- View, Print or Export a csv file from the Panel Usage Reports – **REP**
- Create RFY file – **RFY**
- Go back to 'Layouts' space

4 Detailed Procedures

4.1 Tutorial example

This tutorial is based on an architectural drawing that can be found in section 6.1 below. A DWG of the same tutorial that can be used to trace over can be found in the directory
C:\ProgramData\FRAMECAD\FRAMECAD Steelwise\Training\Tutorial Layout Template.dwg.

Tutorial parameters

- Units = metric
- Loading design code = NASH AS 2010
- Wind speed = N2
- Wall height = 2420mm
- Trusses = 600mm centers
- Truss overhang = Outriggers
- Joists = 450mm centers
- Roof load = Sheet

4.2 Job Setup

1. Start a new job (**N**) or **Ctrl+N**. A new job will open with focus on the 'Layouts' space. A new job will automatically be started when the program is launched called 'Drawing1.dwg'.

IMPORTANT NOTE: NEVER start a new job from an architects dwg or dxf. ALWAYS start from a newly generated drawing or template.

When starting a new job for the very first time and running either the PSET, TSET or JSET commands, the settings dialogue box will open and then a Machine Configurator dialogue will open over the top of it. This dialogue box is to allow you to ensure that the profiles in your SWD file are using the correct machine to start with and to then allow you to reset profiles to be run from a different machine which is capable of producing the same size profile, if another one is available in the dropdown list.

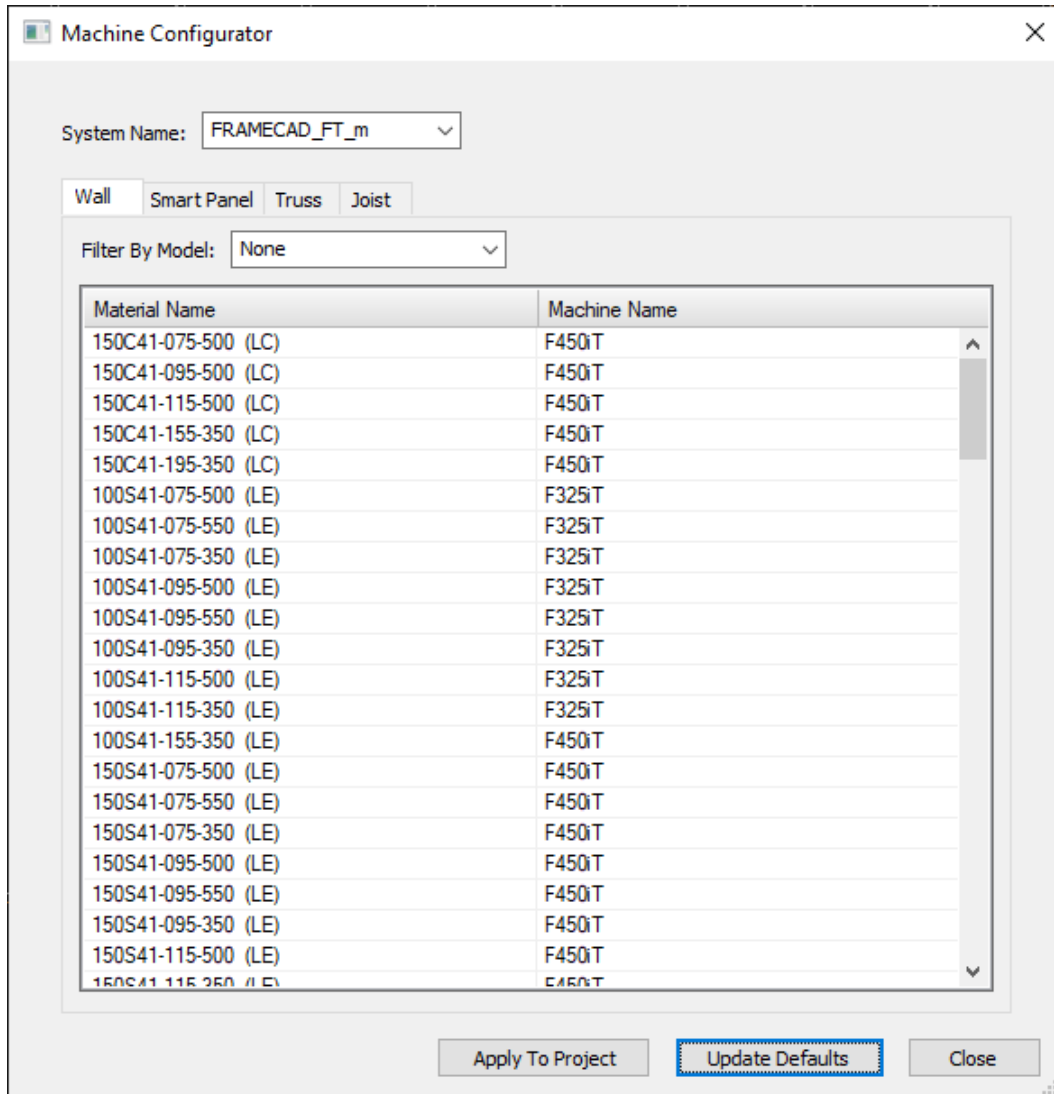

The Machine Configurator shows the System Name and all the material that is able to be rolled and the associated available machines. This allows you to modify which machine is used to run each profile. You will need to do this for each frame type: Wall, Smart Panel, Truss, Joist. The available profiles can also be filtered down by the framing Model.

If the "Do not pop up this window again" option at the bottom of the dialogue is ticked, then the Machine Configurator will no longer pop up for future jobs - but you can still access this dialogue again by either clicking on the ellipsis button to the right of the **Machine Used** in the settings; or by clicking on the **Machine Usage** button along the ribbon menu; or by running the **MACHINE_CONFIG** command.

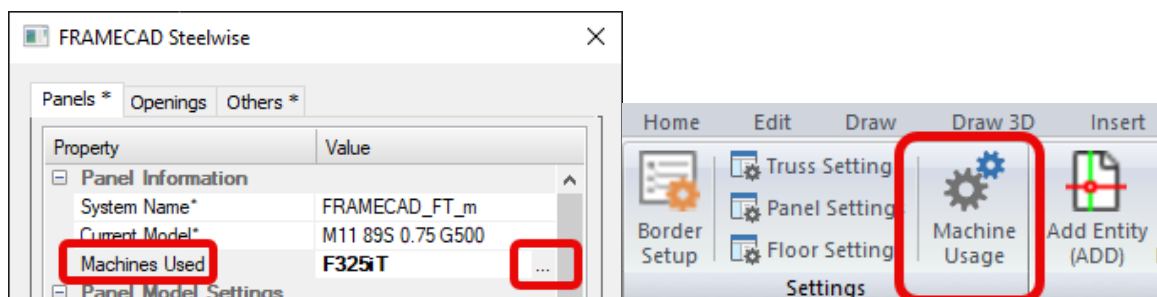

If changes are made within the Machine Configurator, the user has the option to either:

- **Apply to Project** – this will only apply the changes to the current project.
- **Update Defaults** – this will create a xxx_USER.swm machine file in your **C:\ProgramData\FRAMECAD\FRAMECAD Steelwise\Library** directory. This will then take precedence with the newly updated machine option changes whenever a new job is started.
- **Close** – click on this if you wish to close the Machine Configurator without saving any changes.

If you wish to revert back to the original settings, you just need to delete the xxx_USER.swm machine file.

2. Go to the Border Setup (**BSET**). The **ADD** command will also open BSET if there are no existing layout borders in the job.

NOTE: BSET is the most important step in the creation of a job and MUST be implemented before proceeding any further with this program. Failure to create BSET borders will render the job inoperable as software intelligence is imbedded into each border.

3. Edit the job details and border quantities in the 'Client Options' section.

One border per level of walls, trusses and joists. Provide additional borders as required for each level of wall bracing plan, roof truss uplift plan, slab or sub-floor plan, and construction details.

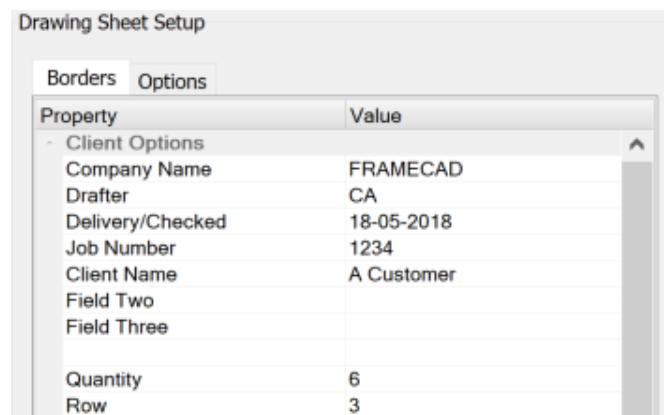

4. In the 'Sheet Options' section, set the sheet size, scale and drawing units (metric or imperial).



- In the 'Design Codes' section, set project information, units, and design code appropriate for the project location. Select the preferred engineering method for walls, bracing, joists and trusses as outlined in section 2.3, and insert borders as required – **BSET** (Border Settings)

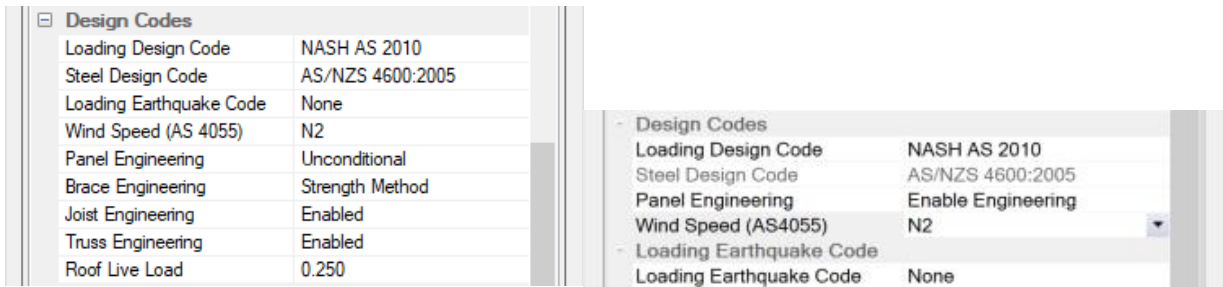

- Click on 'Insert'. (Note: The Layouts space will automatically zoom to the the first border, View '1').

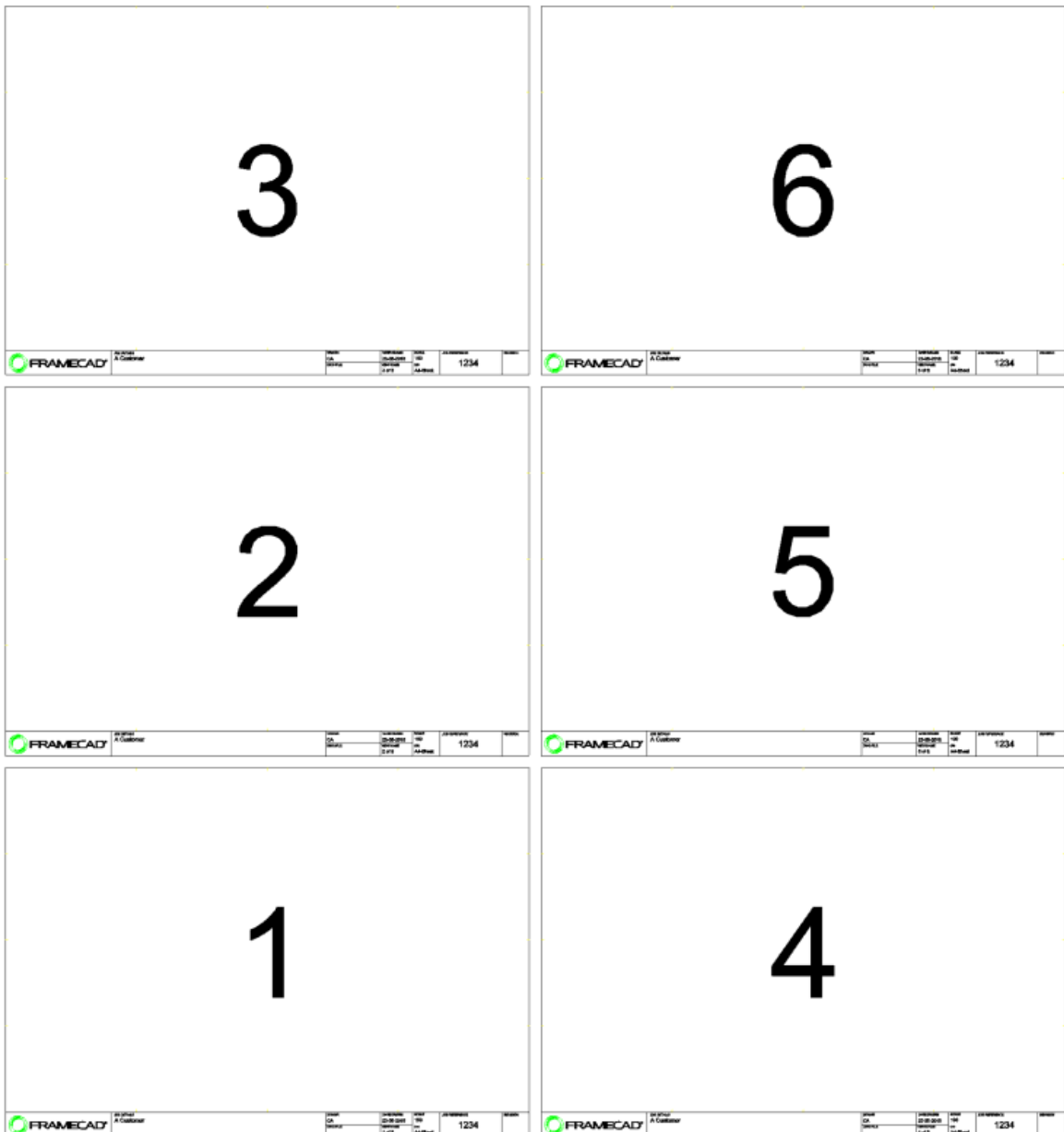

Once the layout borders have been inserted, the location or size of the borders must not be changed. It is, however, possible to add or remove layout borders to the selected space by running the BSET command again and editing the 'Quantity'.

7. Go to the Truss Settings (**TSET**) to set required roof properties. Truss settings should be completed before the wall settings as the wind and roof loads for the walls are picked up from here.
 - a) Ensure the correct System is selected. **FRAMECAD_FT_m** is the standard data file for metric use and **FRAMECAD_FT_i** is the standard data file for imperial use. One of these data files must be used unless instructed otherwise by FRAMECAD.
 - b) Change the Model if the Default model is not being used.
 - c) Ensure the correct Machine Name is set.
 - d) Ensure the correct Roof Load is set.
 - e) Ensure the correct wind speed and snow loads are set correctly. The wind speed value is picked up from the BSET border settings. If it is incorrect, go back to BSET and make the change.
 - f) Review all other parameters.

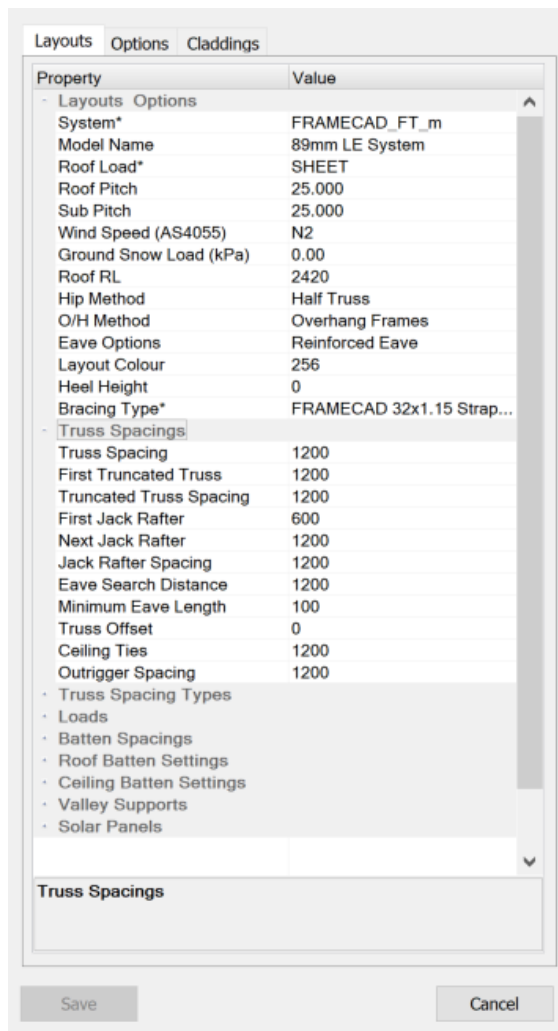

| Property | Value |
|---------------------------|---------------------------|
| - Layouts Options | |
| System* | FRAMECAD_FT_m |
| Model Name | 89mm LE System |
| Roof Load* | SHEET |
| Roof Pitch | 25.000 |
| Sub Pitch | 25.000 |
| Wind Speed (AS4055) | N2 |
| Ground Snow Load (kPa) | 0.00 |
| Roof RL | 2420 |
| Hip Method | Half Truss |
| O/H Method | Overhang Frames |
| Eave Options | Reinforced Eave |
| Layout Colour | 256 |
| Heel Height | 0 |
| Bracing Type* | FRAMECAD 32x1.15 Strap... |
| - Truss Spacings | |
| Truss Spacing | 1200 |
| First Truncated Truss | 1200 |
| Truncated Truss Spacing | 1200 |
| First Jack Rafter | 600 |
| Next Jack Rafter | 1200 |
| Jack Rafter Spacing | 1200 |
| Eave Search Distance | 1200 |
| Minimum Eave Length | 100 |
| Truss Offset | 0 |
| Ceiling Ties | 1200 |
| Outrigger Spacing | 1200 |
| - Truss Spacing Types | |
| - Loads | |
| - Batten Spacings | |
| - Roof Batten Settings | |
| - Ceiling Batten Settings | |
| - Valley Supports | |
| - Solar Panels | |
| Truss Spacings | |

- g) After changes have been made to the settings, they will be maintained for future jobs unless you change either the System, Model or Roof Load. However, you can permanently save these for future use by holding down the 'ALT' key and clicking on 'System*'. These settings will be saved to a user defined data file which can be updated at any stage by repeating the above procedure.
8. Go to the Wall Panel Settings (PSET) to set required wall properties.
- Ensure the correct System is selected. **FRAMECAD_FT_m** is the standard data file for metric use and **FRAMECAD_FT_i** is the standard data file for imperial use. One of these data files must be used unless instructed otherwise by FRAMECAD.
 - Change the Model if the Default model is not being used.
 - Review other parameters.

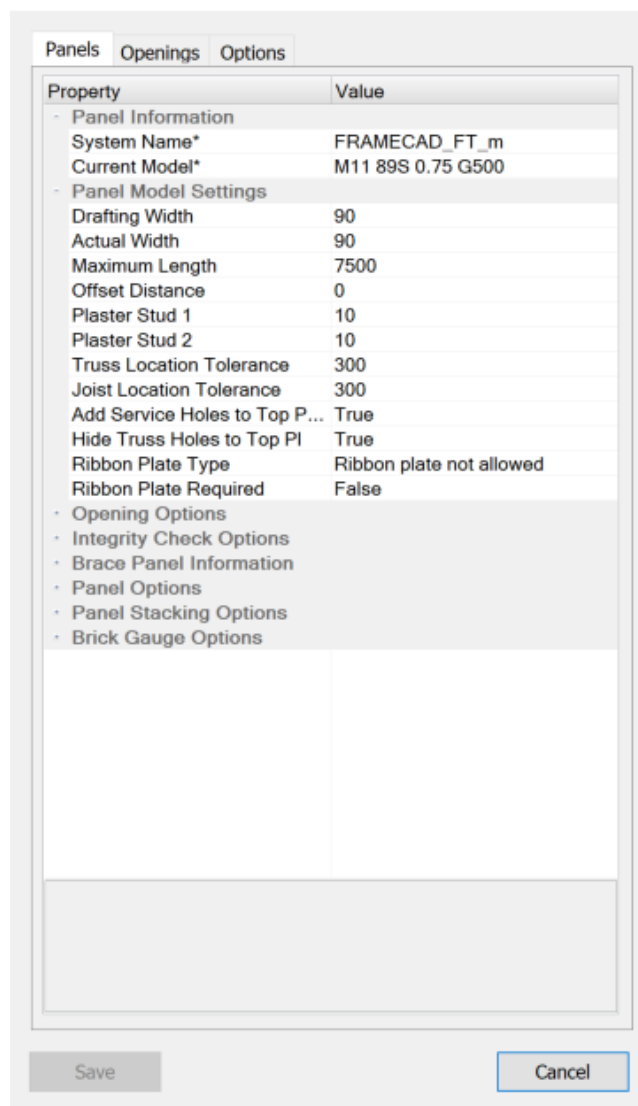

| Property | Value |
|-------------------------------|--------------------------|
| - Panel Information | |
| System Name* | FRAMECAD_FT_m |
| Current Model* | M11 89S 0.75 G500 |
| - Panel Model Settings | |
| Drafting Width | 90 |
| Actual Width | 90 |
| Maximum Length | 7500 |
| Offset Distance | 0 |
| Plaster Stud 1 | 10 |
| Plaster Stud 2 | 10 |
| Truss Location Tolerance | 300 |
| Joist Location Tolerance | 300 |
| Add Service Holes to Top P... | True |
| Hide Truss Holes to Top PI | True |
| Ribbon Plate Type | Ribbon plate not allowed |
| Ribbon Plate Required | False |
| - Opening Options | |
| - Integrity Check Options | |
| - Brace Panel Information | |
| - Panel Options | |
| - Panel Stacking Options | |
| - Brick Gauge Options | |

- d) After changes have been made to the settings, they will be maintained for future jobs unless you change either the System or Model. However, you can permanently save these for future use by holding down the 'ALT' key and clicking on 'System Name*'. These

settings will be saved to a user defined data file which can be updated at any stage by repeating the above procedure.

- e) If you wish to have different settings applied to different framing models, then hold down the 'ALT' key and click on 'Current Model*'.
9. Go to the Joist Settings (JSET) to set required floor joist properties.
 - a) Ensure the correct System is selected. **FRAMECAD_FT_m** is the standard data file for metric use and **FRAMECAD_FT_i** is the standard data file for imperial use. One of these data files must be used unless instructed otherwise by FRAMECAD.
 - b) Select the correct Model. This will populate the Joist and Side Bearer types then it will revert to 'Select' again.
 - c) Ensure correct floor loads are selected.
 - d) Review other parameters.

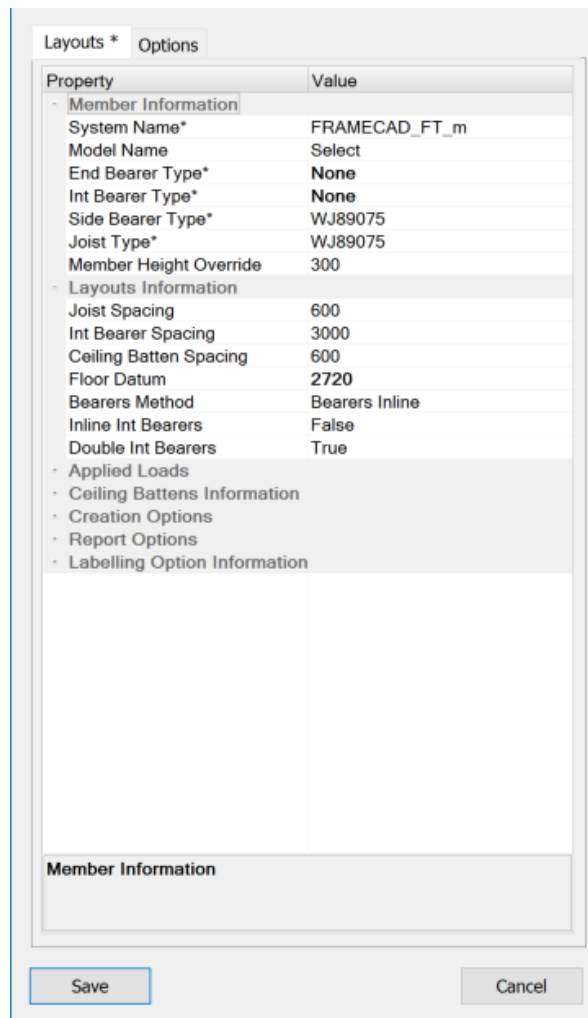

| Property | Value |
|-------------------------------------|----------------|
| Member Information | |
| System Name* | FRAMECAD_FT_m |
| Model Name | Select |
| End Bearer Type* | None |
| Int Bearer Type* | None |
| Side Bearer Type* | WJ89075 |
| Joist Type* | WJ89075 |
| Member Height Override | 300 |
| Layouts Information | |
| Joist Spacing | 600 |
| Int Bearer Spacing | 3000 |
| Ceiling Batten Spacing | 600 |
| Floor Datum | 2720 |
| Bearers Method | Bearers Inline |
| Inline Int Bearers | False |
| Double Int Bearers | True |
| Applied Loads | |
| Ceiling Battens Information | |
| Creation Options | |
| Report Options | |
| Labelling Option Information | |
| Member Information | |

- e) After changes have been made to the settings, they will be maintained for future jobs unless you change either the System or Model. However, you can permanently save these for future use by holding down the 'ALT' key and clicking on 'System Name*'. These

settings will be saved to a user defined data file which can be updated at any stage by repeating the above procedure.

4.3 Building/Slab Layout Plan

1. Go to the first border (View 1) by typing **'V'** Enter, **'1'** Enter.
2. Ensure entity snaps are turned on. Useful snaps at this stage are **Endpoint, Midpoint, Perpendicular** and **Intersection**

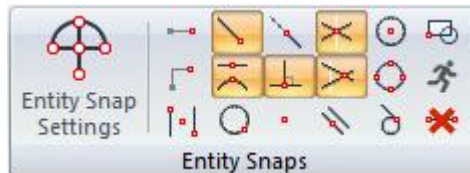

Note: Do not select too many snaps as this will slow the program down dramatically.

Side Note: Snap options change depending on which command is activated and what selection process is required within the command. The user can override these at any stage.

3. Draw the outline of the building by using a Polyline (**P**) to create. It is recommended that a polyline is always closed using the (**C**) Close option on the last line segment input. Make sure building is centralised as much as possible within the border. A useful tool for this is the Centered (**CTR**) command.

See 6.1 Tutorial Drawing at the back of this document for dimensions.

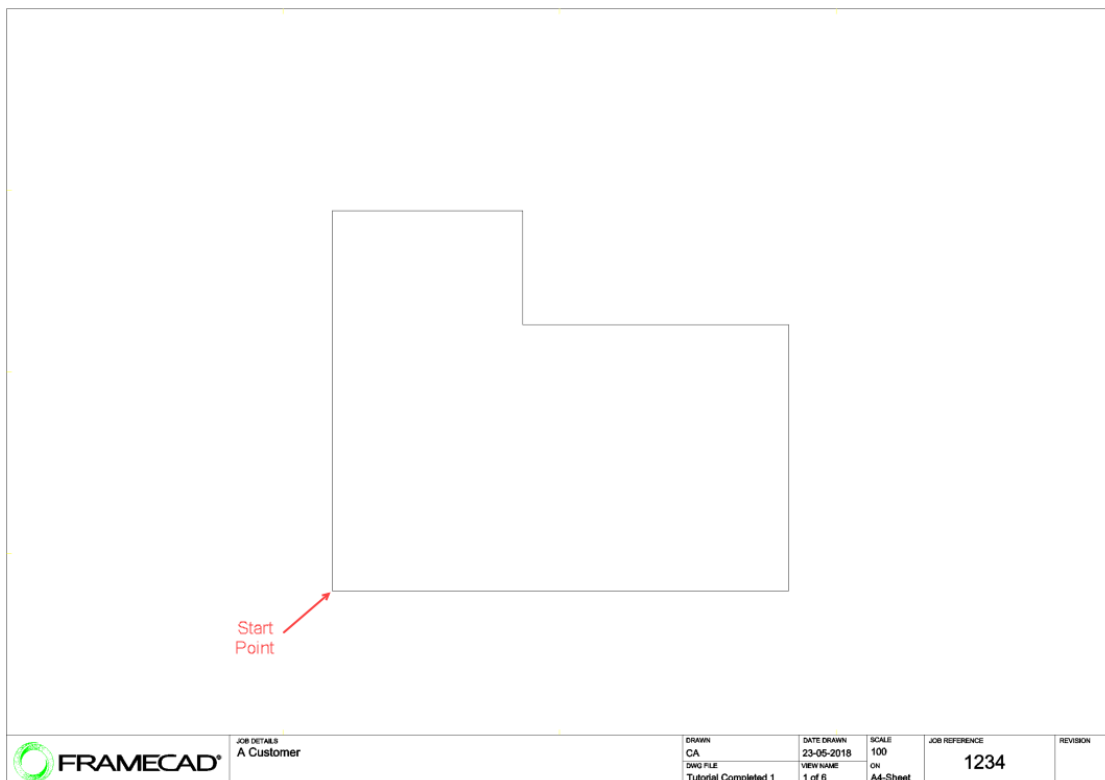

4. Alternatively, you can import an architect's dwg or dxf to trace around using a polyline (**P**). A Tutorial drawing file can be found in the directory *C:\ProgramData\FRAMECAD\FRAMECAD Steelwise\Training\ Tutorial Layout Template.dwg*.

Note: Never start a new job from an architects dwg or dxf. ALWAYS start from a newly generated drawing or template.

5. Open this file then select the layout by dragging a fence across the drawing using your mouse. Copy the drawing (Ctrl+C), go to your drawing file, then paste the architect's layout into View 2 (Ctrl+P) and click on an insertion point. View 2 is the border that will be used for the wall framing input. Move the layout to the most appropriate location as close to the centre as possible.
6. Place the architectural layout onto a temporary layer (Temp_Layer) by typing **LX** then selecting the layout. The program has the facility to use six different temporary layers (LX, LX1, LX2, LX3, LX4, LX5).

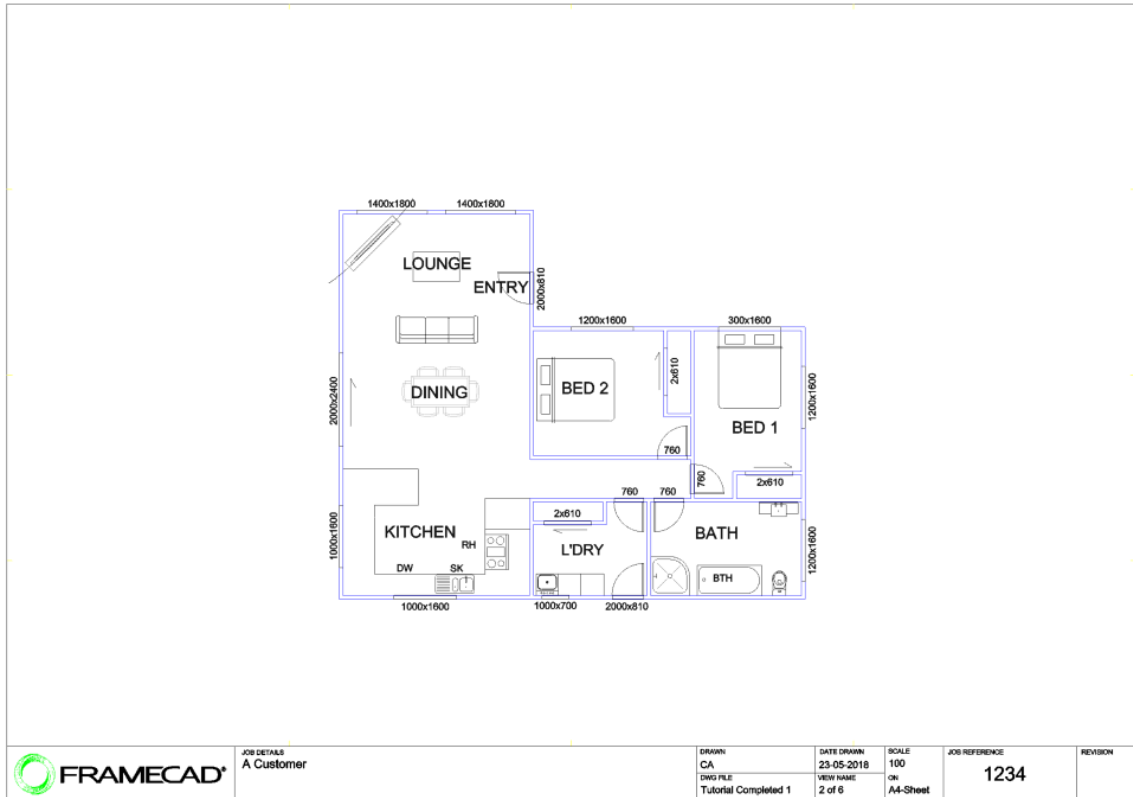

7. Use **LT** (LT1, LT2, LT3, LT4, LT5) to toggle the Temp_Layer off and on as required.
8. Draw around the outline of the building by using a Polyline (**P**). It is recommended that a polyline is always closed using the (**C**) Close option on the last line segment input.
9. Type **LT** to toggle the Temp_Layer off.
10. Use the Copy (**C**) command to copy the polyline outline from View 2 to View 1 (for the foundation layout), and View 3 (for the truss layout). Select the Escape key or press enter to exit the copy command.

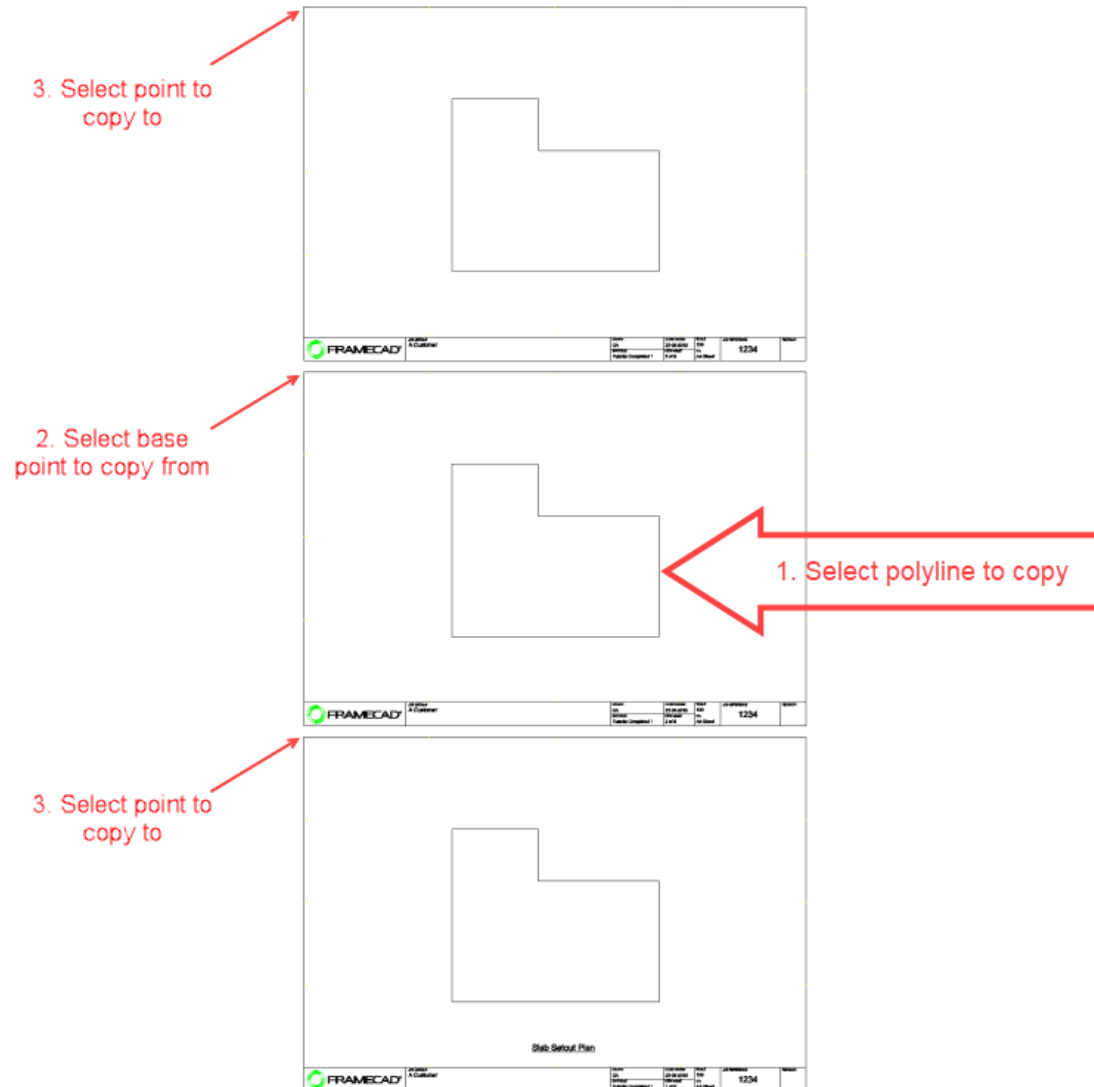

11. **NOTE:** It is recommended that the outline is copied to the exact same location within each border by selecting a base point to copy from and selecting the same locations on the other borders to copy to. Use a corner of each border as the 'base point' and the 'copy to' point.

12. Save the file in a folder named for the project.

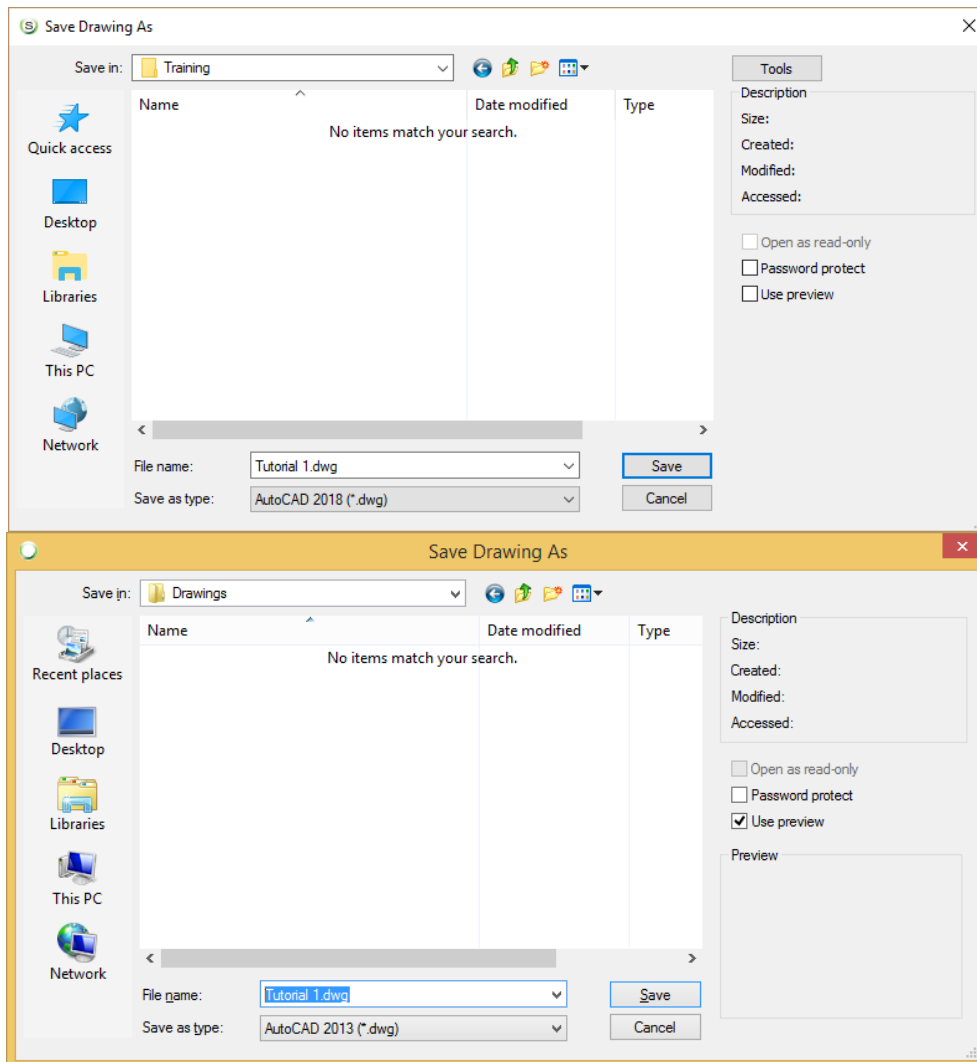

13. In View 1, use the Line tool (**L**) to draw any diagonal lines required to represent slab diagonal measurements.

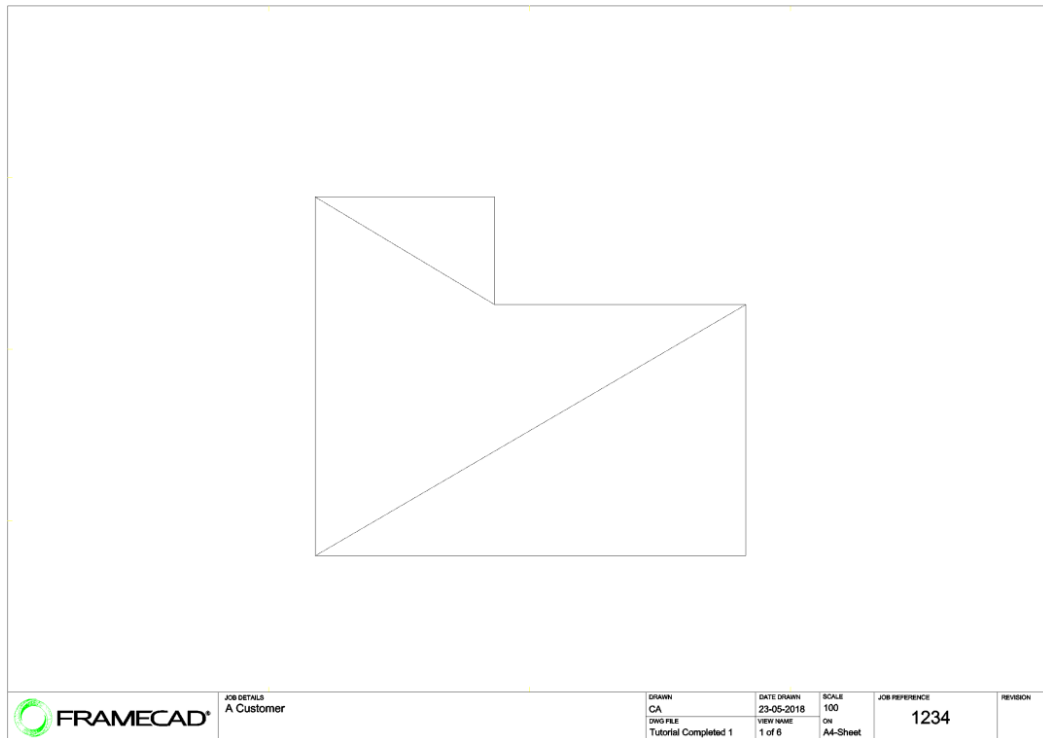

14. Dimension lines (**DL**) on View 1 as required for Slab Layout. Use Quick Text (**QT**) to place plan label 'Slab Setout Plan'.

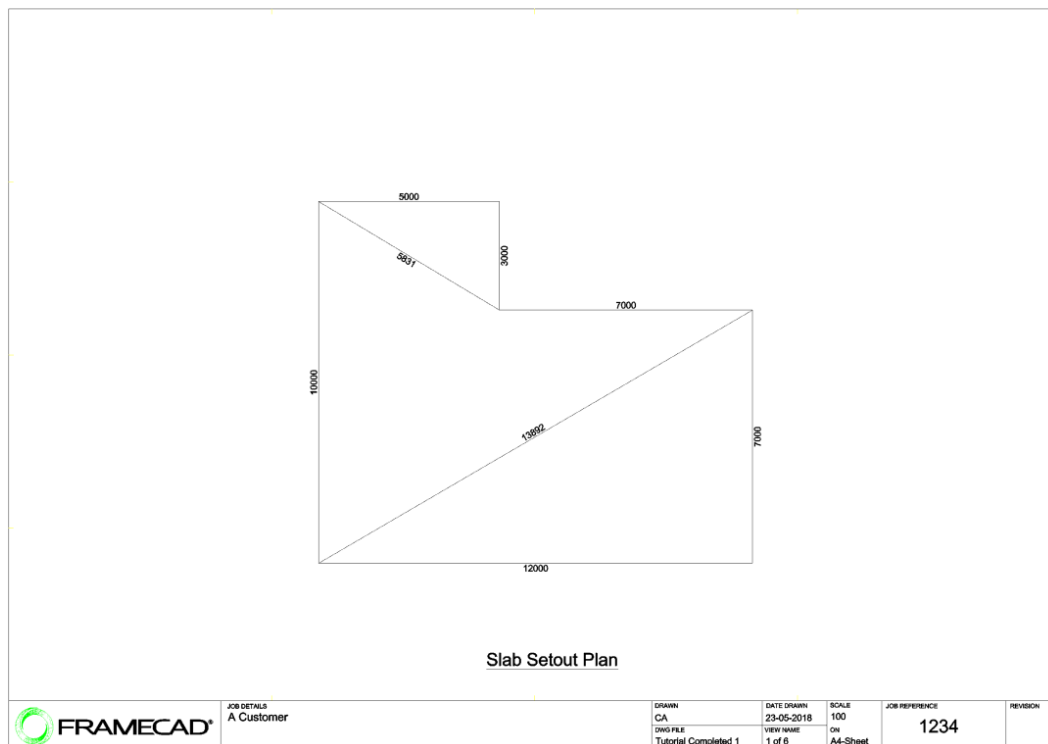

...SAVE THE JOB...

4.4 Wall Panel and Beam Input

1. Change to View 2. To do so type **'V'** Enter, **'2'** Enter.
2. Using the input command **ADD (A)**, select the 'Wall' input option.

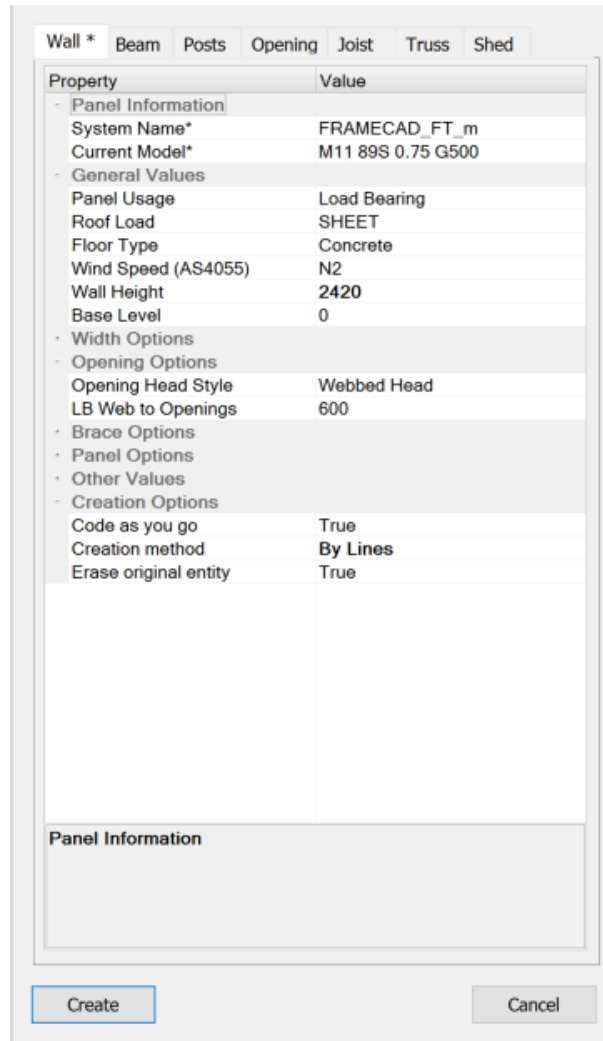

| Property | Value |
|--------------------------|-------------------|
| Panel Information | |
| System Name* | FRAMECAD_FT_m |
| Current Model* | M11 89S 0.75 G500 |
| General Values | |
| Panel Usage | Load Bearing |
| Roof Load | SHEET |
| Floor Type | Concrete |
| Wind Speed (AS4055) | N2 |
| Wall Height | 2420 |
| Base Level | 0 |
| Width Options | |
| Opening Options | |
| Opening Head Style | Webbed Head |
| LB Web to Openings | 600 |
| Brace Options | |
| Panel Options | |
| Other Values | |
| Creation Options | |
| Code as you go | True |
| Creation method | By Lines |
| Erase original entity | True |

Panel Information

Create Cancel

3. Click on 'Settings' at the bottom of the dialogue box to go to the **PSET** if the initial settings need to be changed. Save or Cancel to go back to the **ADD** dialogue.
4. Check and change any 'General Values' as required.

Note: Settings under the 'Other Values' section are only relevant if there is no roof truss or floor joist layouts which would otherwise automatically add loads when referenced.

5. Wall Creation Method By Lines:
 - a) Under 'Options', select 'Creation Method: By Lines' then click on 'Create'.



| | |
|-------------------------|----------|
| Creation Options | |
| Code as you go | True |
| Creation method | By Lines |
| Erase original entity | True |

Tip: Double clicking on a property will automatically change to the next value option.

- b) Select the polyline then click on the side of the line for the wall placement.

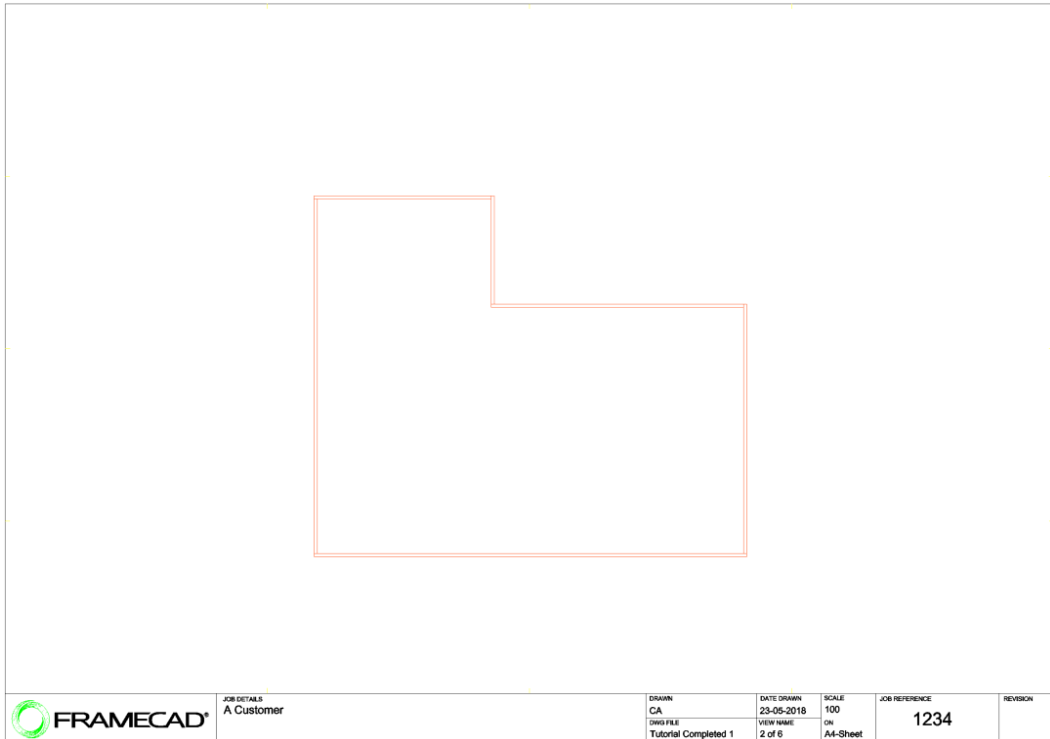

- c) If lines are present instead of polylines, these can be used for individual wall placement.
 - d) Walls input using this method will already be coded if 'Code as you go: True' is selected.
 - e) Use the Member Fillet (**MF**) command to tidy up any unresolved wall intersections if required.
6. Type **LT** to toggle the Temp_Layer on.
 7. Wall Creation Method By Points:
 - a) Change 'Panel Usage' to 'Non-Load Bearing'.
 - b) Under 'Creation Options', select 'Creation Method: By Points' then click on 'Create'.

| Property | Value |
|-----------------------|-------------------------|
| - Panel Information | |
| System Name* | FRAMECAD_FT_m |
| Current Model* | M11 89S 0.75 G500 |
| - General Values | |
| Panel Usage | Non Load Bearing |
| Roof Load | SHEET |
| Floor Type | Concrete |
| Wind Speed (AS4055) | N2 |
| Wall Height | 2420 |
| Base Level | 0 |
| - Width Options | |
| - Opening Options | |
| - Brace Options | |
| - Panel Options | |
| - Other Values | |
| - Creation Options | |
| Code as you go | True |
| Creation method | By Points |
| Erase original entity | True |

- c) Select the start point and end point of the wall, then the direction (or side of line) to place the frame.

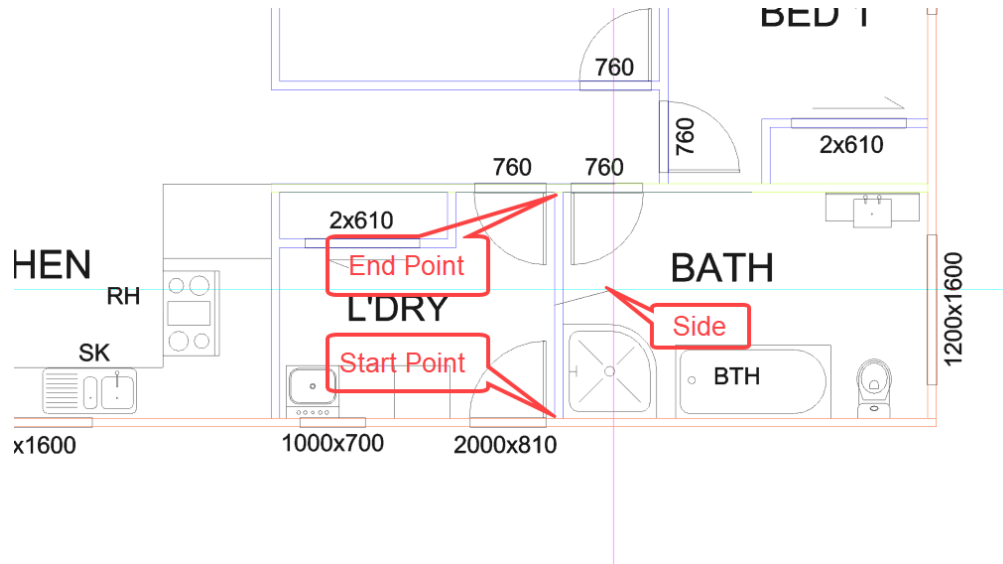

- d) This option can be set to code the walls on input.
 e) The Panel Draw (**PD**) command also inputs walls by points. Just note that walls input using the **PD** command are not coded.

8. Edit the walls using the following editing commands:

Menu location - Steelwise | Editing:

- o **C** – Copy
- o **MF** – Member Fillet. Laps two walls together or changes the lap orientation.
 First click indicates lapping frame

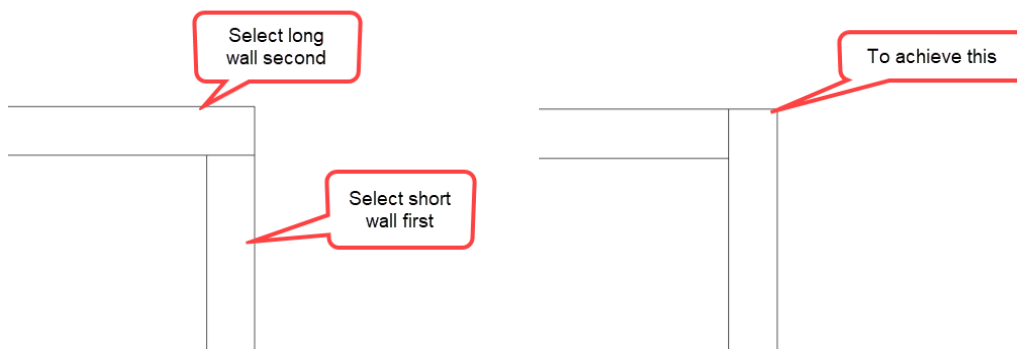

- o **ME** – Member Extend. Extends to another wall frame in either a positive or negative direction.

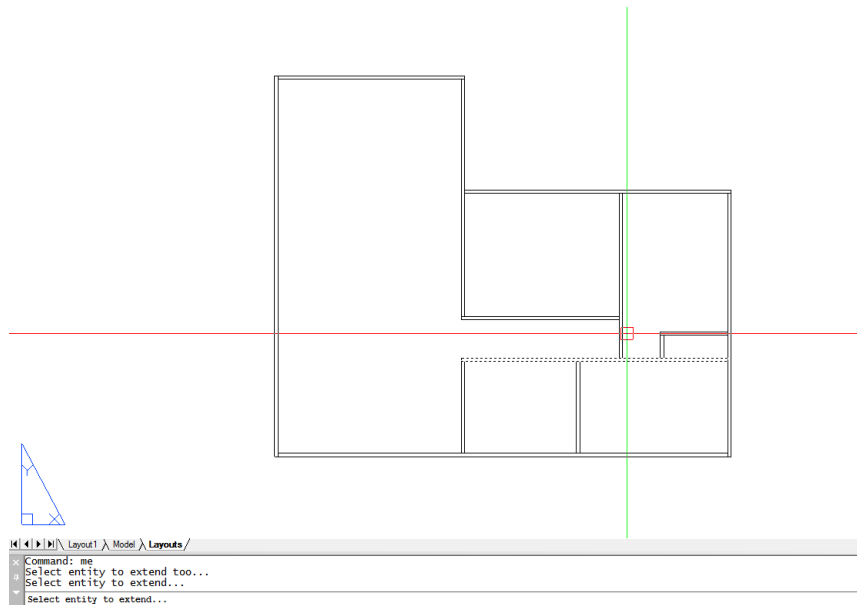

- **IP** – Inherit Properties
 - **MJ** – Member Join. Joins contiguous panels/members together
 - **M** – Move
 - **MC** – Member Cut. Cuts a panel at a specified point
 - **MI** – Mirror
 - **ML** – Member Lengthen. Lengthens or shortens by a given amount. Enter the distance, select the member or members and right click to activate change. The end of the member closest to that selected will be modified.
 - **MR** – Member Reverse, Swaps the start and end points of a wall.
 - **MX** – Member Crossing. Auto adjusts panels or members crossing over each other.
 - **MO** – Offset. Offsets by inside dimension i.e. dimension distance between walls.
9. Listing the panels (**LI** -List) will take you to the 'Panel Coding Editor' for non-coded panels, or to the 'Panel Properties Editor' for coded panels.

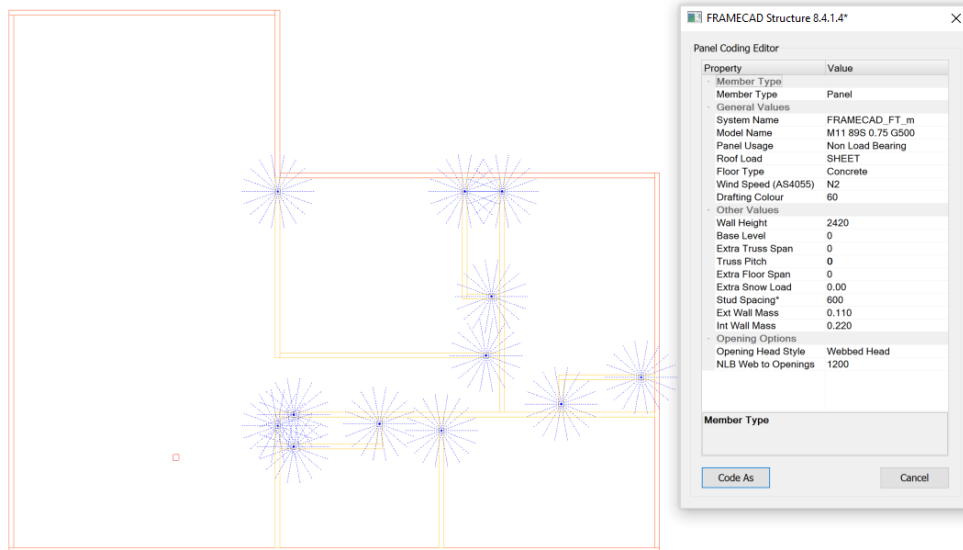

10. When listing non-coded panels - define the initial values such as member type (Panel or Beam), panel usage (Load Bearing, Structural Only or Non-Load Bearing), wind load, frame height, base level and other settings. Click on 'Code As'.
11. When listing coded panels, more options become available to change including the option to convert a panel to a beam or visa-versa.

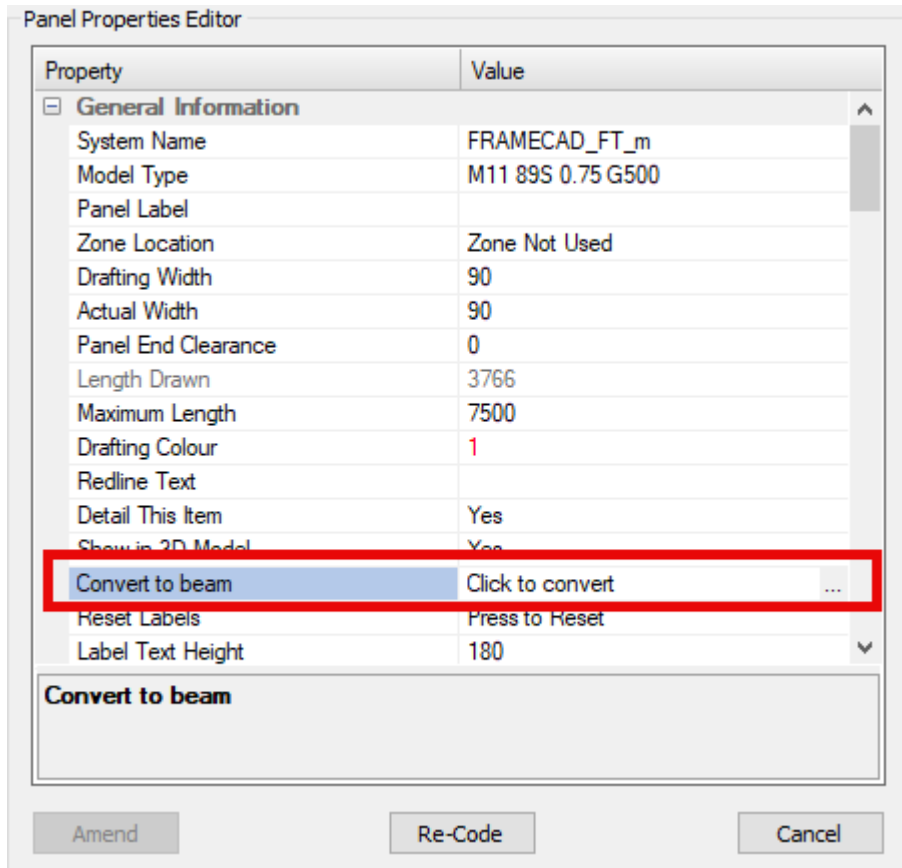

12. Dimension wall layout as required:

- **DA** – Dimension Aligned. Aligns dimensions based on the first 2 selected points.
- **DM** –Dimension Member. Creates linear dimensions perpendicular to selected members. In BSET | Options | Dimension Options | Width Options, 'Show Panel Widths: True' will dimension the width of the selected members; 'Show Panel Widths: False' will dimension to the centre, nearest edge, farthest edge, front edge or rear edge as set in the 'Linear Dimension' parameters.
- **DH** – Dimension Horizontal. Creates horizontal dimensions between selected points.
- **DV** – Dimension Vertical. Creates vertical dimensions between selected points.

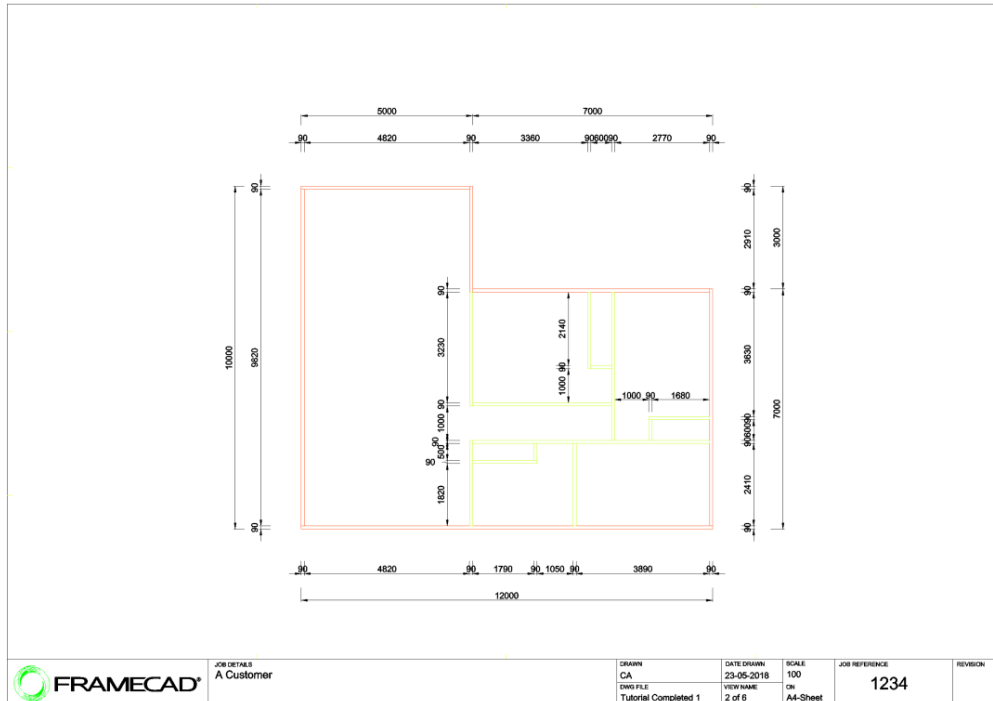

13. Place doors and windows (**ADD** - Opening).

- Select User Defined Window or User Defined Door and click on 'Create' to start input (double clicking on the option will also work). Alternatively type **UW** or **UD**.
- To edit the window head height, type 'H' and change. This is the height from the bottom of the wall frame to the underside of the opening header. For the purposes of this exercise, change this value to 2000. To change any other settings, type 'S' for Setup.

```
Command: UW
'S' to Setup, 'H' for Head Location < 2160 >, or Enter Opening Height...< 1000 >...h
Enter New Head Location < 2160 >...2000
```

Then enter the opening height and width to suit.

- You will then be given a series of input options.

```
Hide, Value, Auto, Centre, Multiple, Point offset, Point, or Side or Select Point for Opening...< P >...
```

Auto - Inputs an opening at a pre-determined distance from a wall intersection.

Centre - Inputs an opening centralised between two selected points along a wall.

Multiple - Inputs multiple openings evenly spaced along a wall.

Point offset - Inputs an opening at a given distance offset from a selected point to the centre of the opening.

Point - Inputs an opening centralised on a selected point.

Side - Inputs an opening at a given distance from a selected point to the nearest side of the opening.

16. Label wall frames (**LA**).

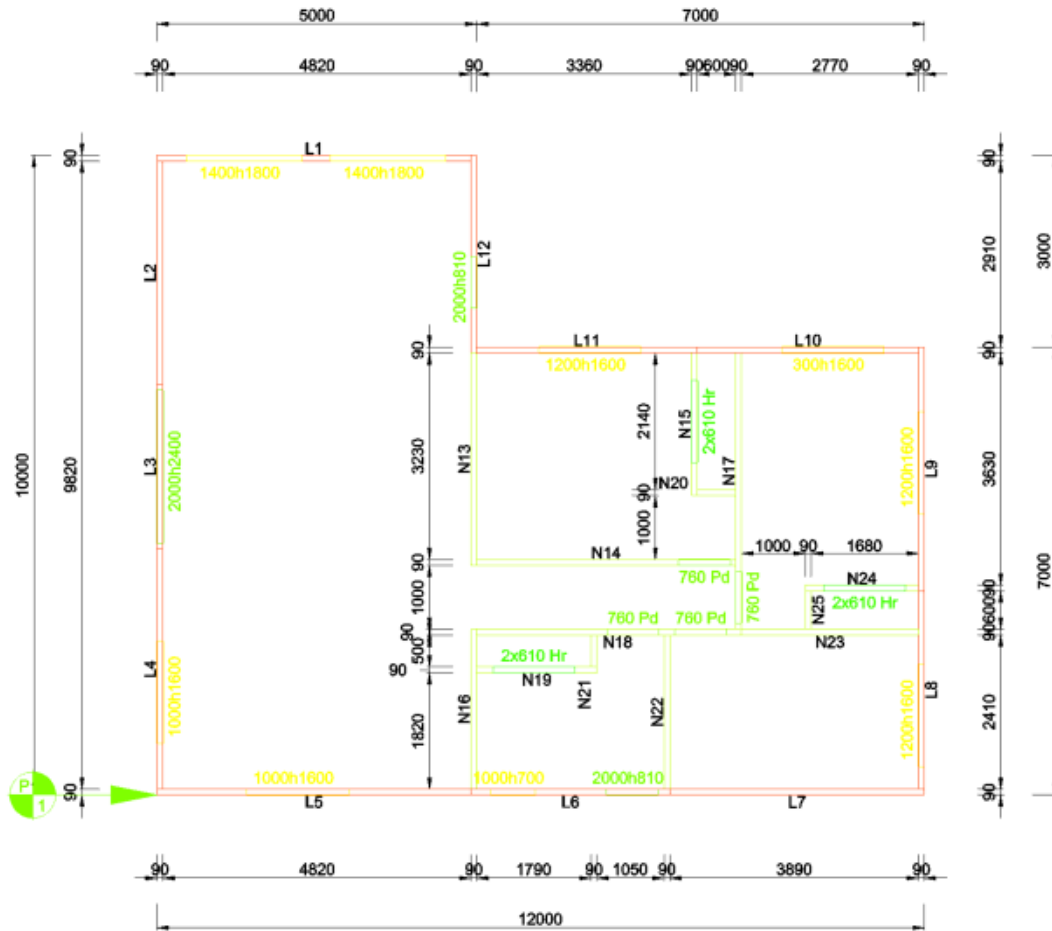

Note: The label is placed on the side of the wall that it is viewed from when in the elevation view.

17. Generally, external walls should be viewed from the outside of the building. Check which side the label is on and reverse (**MR** – Member Reverse) any panels as necessary.
18. Frames are also viewed from left to right when looking at them in elevation view. To find the left hand end of a frame, use the **SHOW** command. Use the **MR** – Member Reverse command to change the starting end if required.
19. To rake wall frames, use the Rake Wall (**PRA**) command. Firstly, ensure that the walls to be raked are set to the height from where they are to be raked from. Select the walls that are to be raked (this can include walls that are parallel to the rake). Select two points that define the base line of the raking plane, then select the direction of the rake. Enter the rake pitch in degrees.
20. If required, use the Stud Array (**PSA**) command to insert a series of studs at given spacings along a wall either by entities or between two points or to input a single or back to back stud.
21. If required, use the Stud Copy (**PSC**) command to copy studs from one level to another. This is useful when studs need to line up through multiple levels of walls.
22. Most layout plans are automatically labelled when the Label (**LA**) command is activated. If you need to place any other labels you can use the Quick Text (**QT**) command.

...SAVE THE JOB...

4.5 Roof Theory

The truss software operates on the basis that every roof is a rectangle or a collection of rectangles. Throughout this training manual these rectangles will be referred to as roof blocks.

Sometimes these roof blocks may merge or overlap, and sometimes they may have more than four sides, but broadly speaking they are still a collection of blocks.

The trick to creating accurate roof plans and truss layouts is to be able to identify the roof blocks. When identifying roof blocks, it is usually easier to start with the smallest blocks and work up to the largest block. Using this method, you can usually simplify the drawing as you go.

The drawing below shows an example of a roof consisting of two roof blocks.

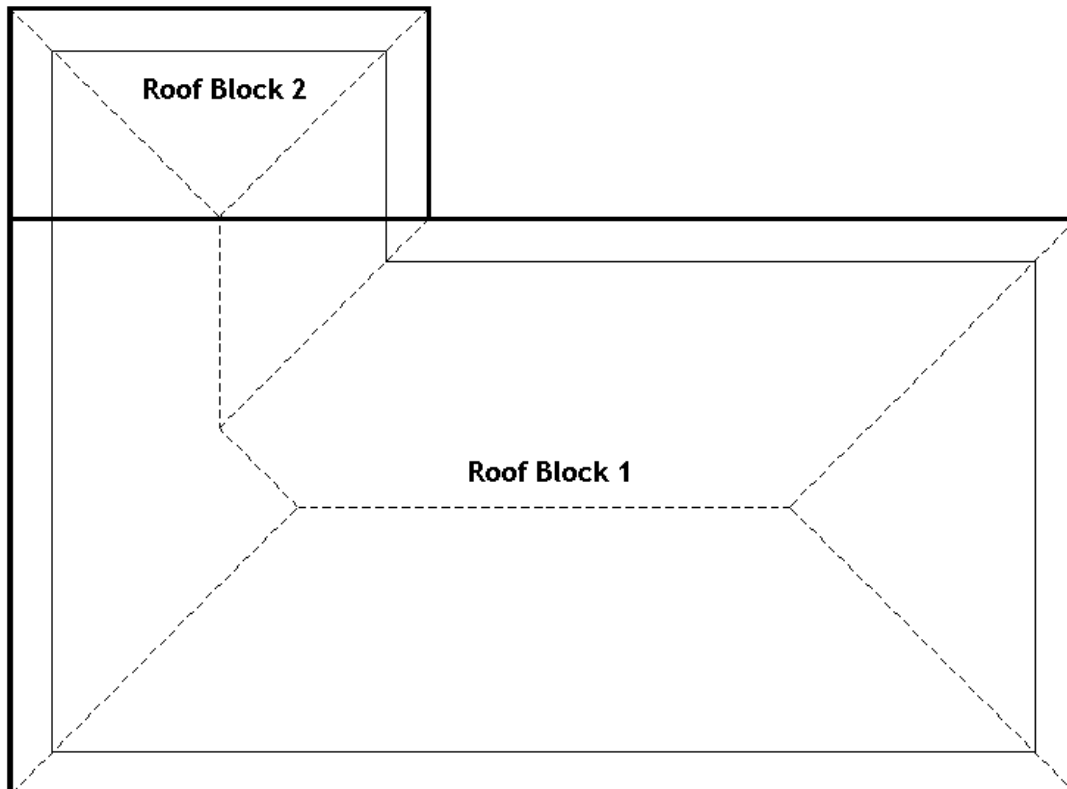

Where the entire roof is of one pitch, all roof lines will be at right angle to each other, with the hips and valleys at 45° angles.

Regardless of the complexity of the roof, the direction of fall is ALWAYS towards a gutter or valley. If ever you have a roof falling to a hip or ridge, you have a problem as water will not run up hill.

This example is a more complex roof consisting of four roof blocks.

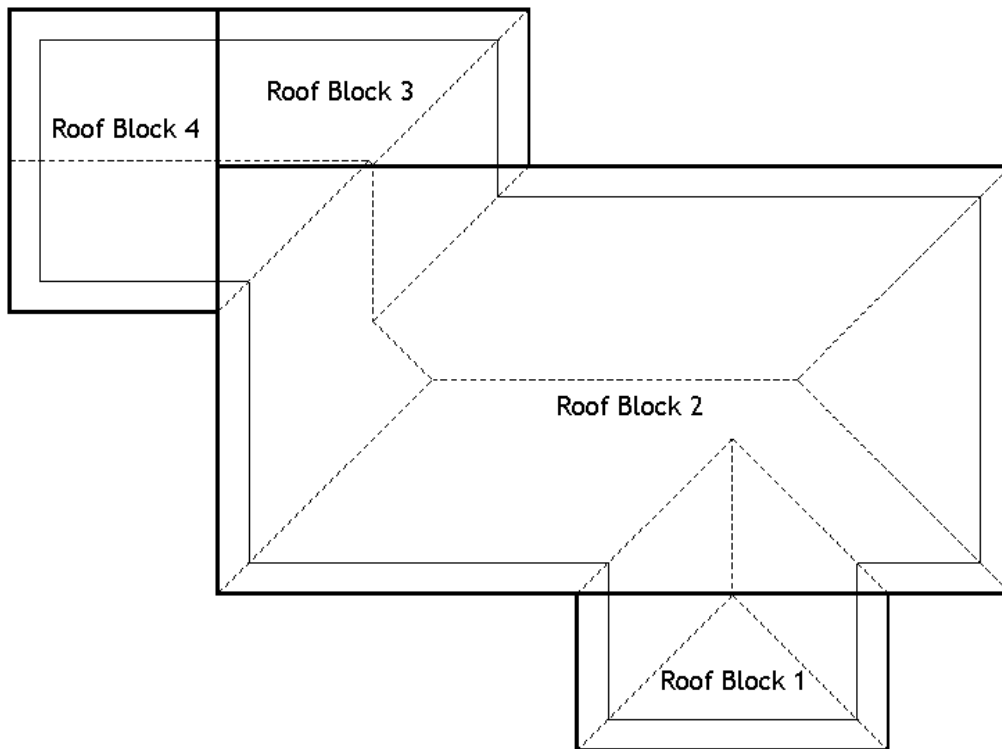
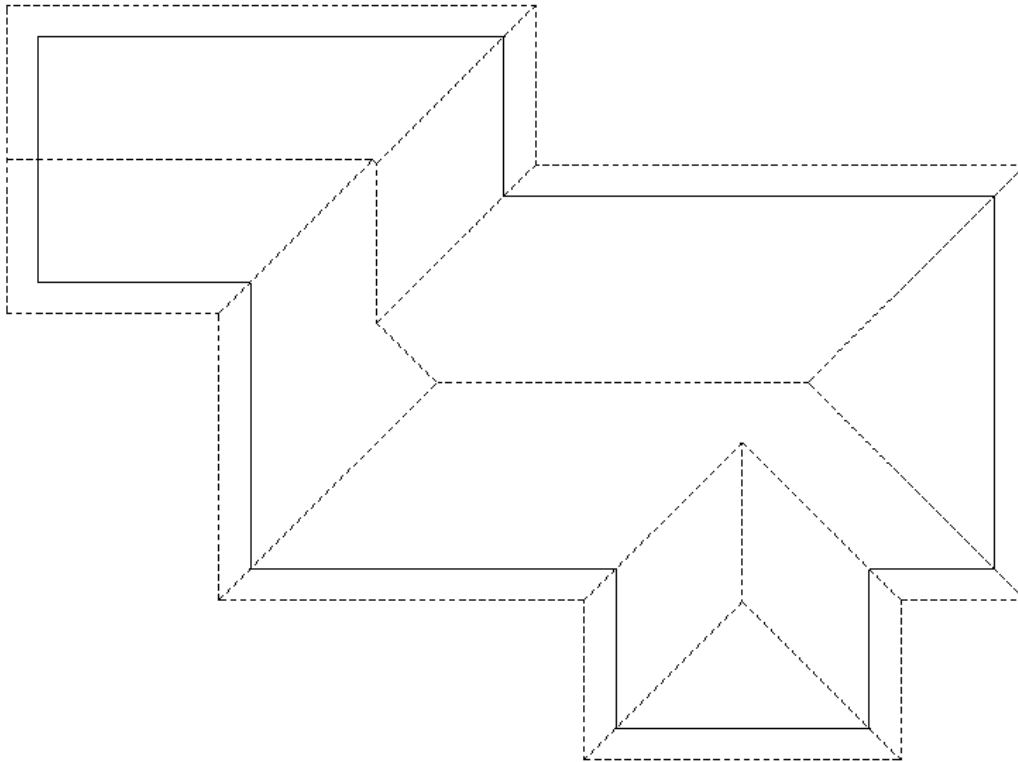

The example below shows a good example of a complex roof. Note the overlap of the two roof blocks. Generally, when you have an overlap of roof blocks, you have a complex roof. The larger the overlap, the more complex the roof.

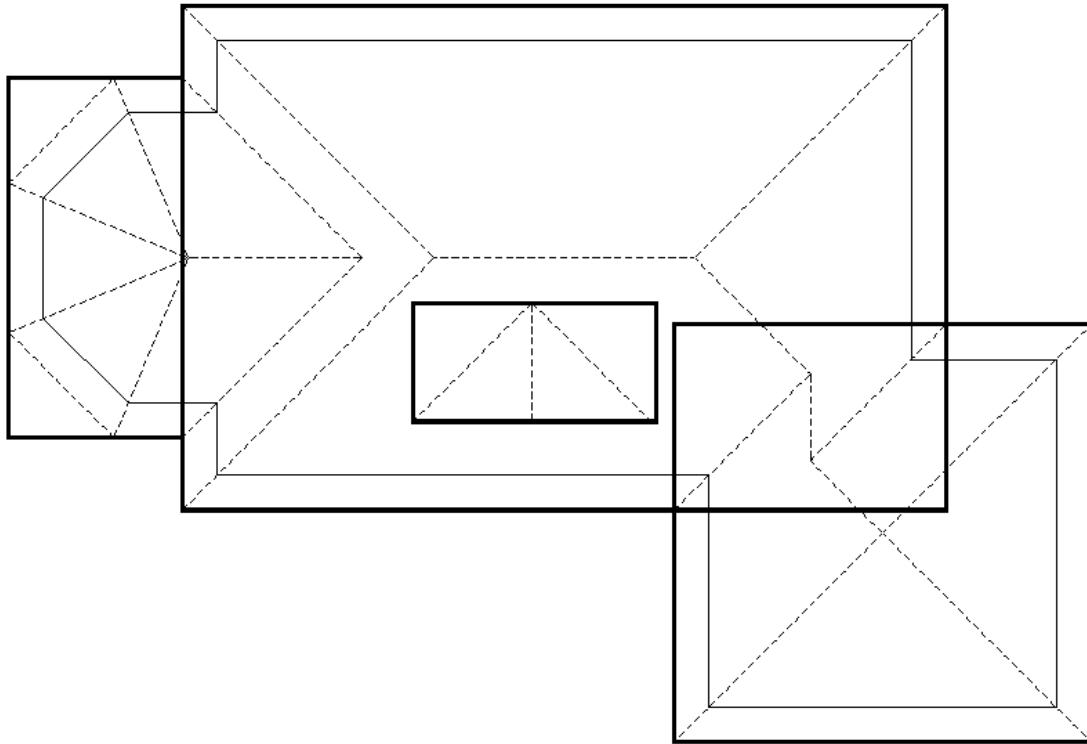

Note the direction of fall. On each occasion the roof MUST fall to a valley or gutter.

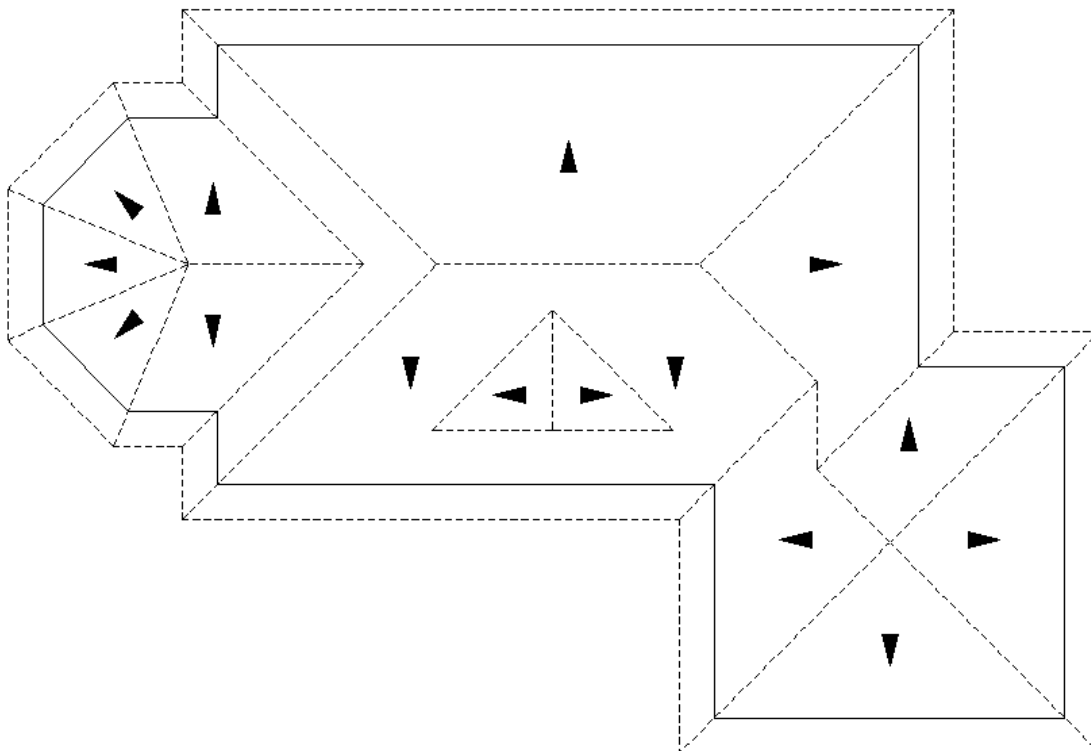

4.6 Truss Layout Input

1. Change to View 3. To do so type 'V' Enter, '3' Enter.
2. Go to Truss Settings (**TSET**) to set required roof properties.
 - a) Ensure the correct System is selected. **FRAMECAD_FT_m** is the standard data file for metric use and **FRAMECAD_FT_i** is the standard data file for imperial use. One of these data files must be used unless instructed otherwise by FRAMECAD.
 - b) Select roof load.
 - c) Review other parameters.

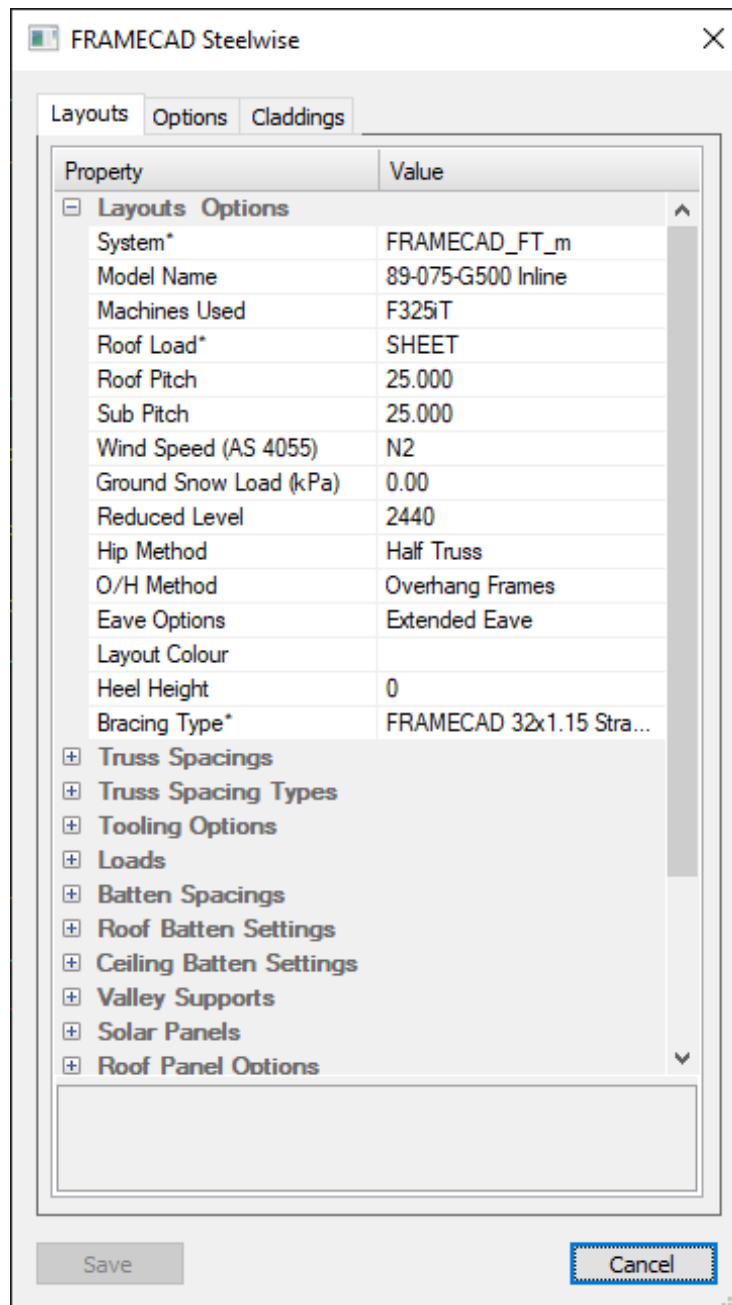

3. Offset the polyline that was input into View 3 (see Section 4.2, Item 10) by the eave dimension using Offset (**O**).

NOTE: If wall entities are copied from the Wall Framing Layout to the Roof Truss Layout, you MUST use the STRIP command to remove all data intelligence from the copied walls. Exploding entities does not remove the data. You must not combine walls, trusses and joists in the same layout plan as it will cause issues with labelling, frame building and reporting.

4. Convert the eave polyline into Roof Lines using Code Roof Line (**RL**). Eave lines should appear dashed blue.

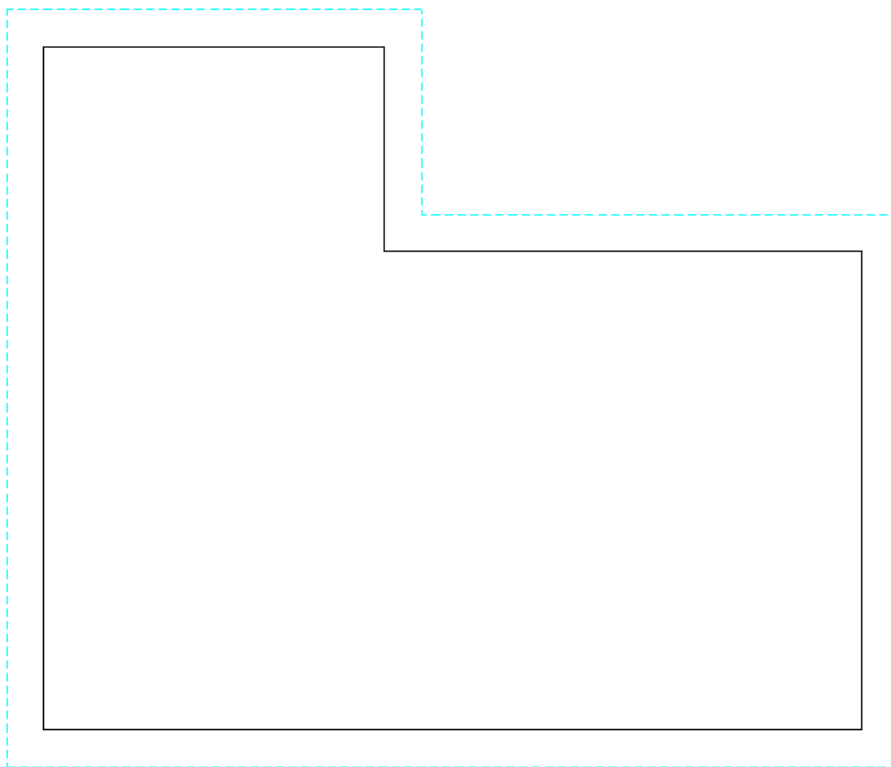

5. Convert the wall polyline into Support Lines using Code Support Line (**SL**). Support lines should appear solid orange.

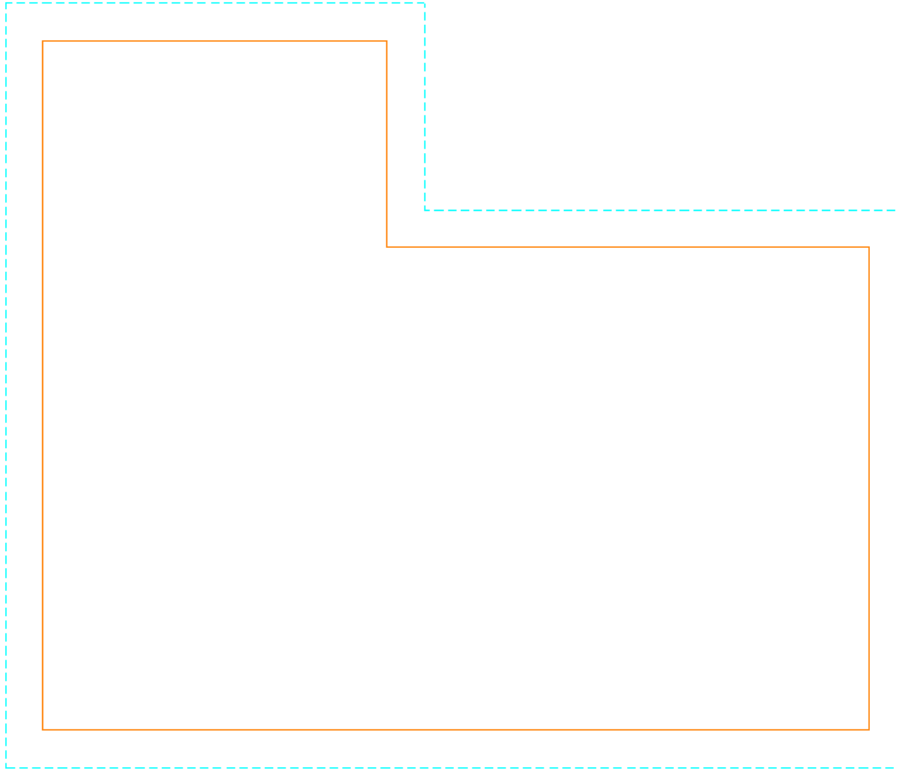

6. Create Hip, Valley and Ridge lines using Create Roof Lines (**CRL**) by selecting Roof Blocks on the Eave Lines (Blue lines only).
 - The first two selection points determine the width of the block. It does not matter which of these two points is selected first.
 - The third selection point determines the length of the block.

7. First block:

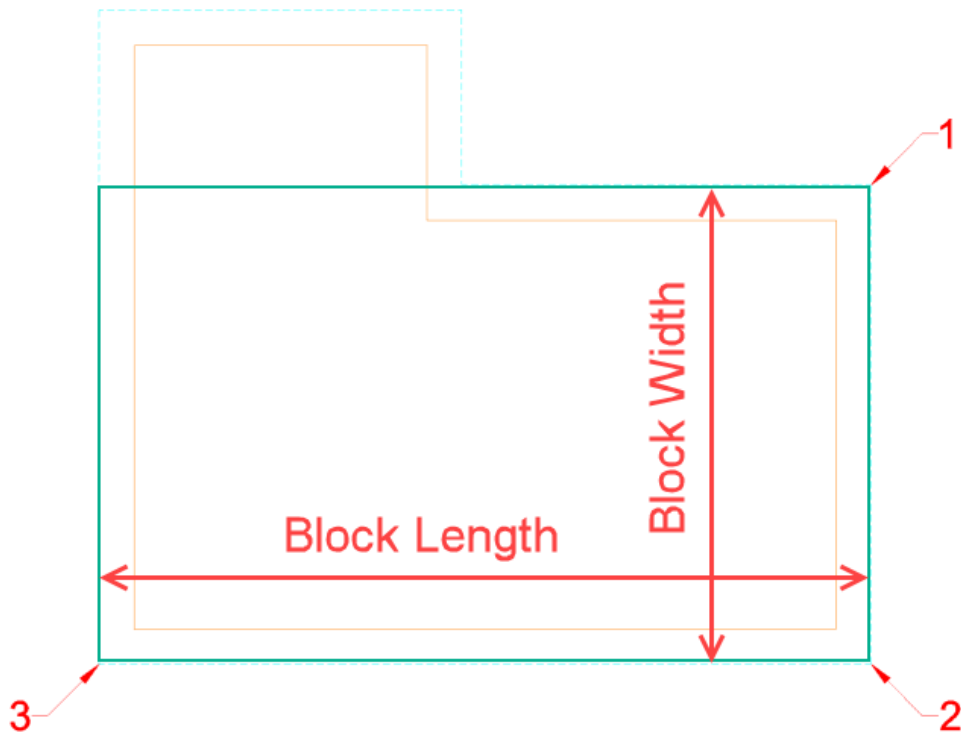

```
Command: CRL  
Right click for setup or select first point for roof lines...  
Select second point for roof lines...  
Select third point for roof lines...  
Select Roof Type...Dutch, Hip, Gable, Saddle, GAmbrel, Boomerang, Radial, Unequal Radial, DOrmer...
```

Type 'H' for Hip for both ends of the roof block

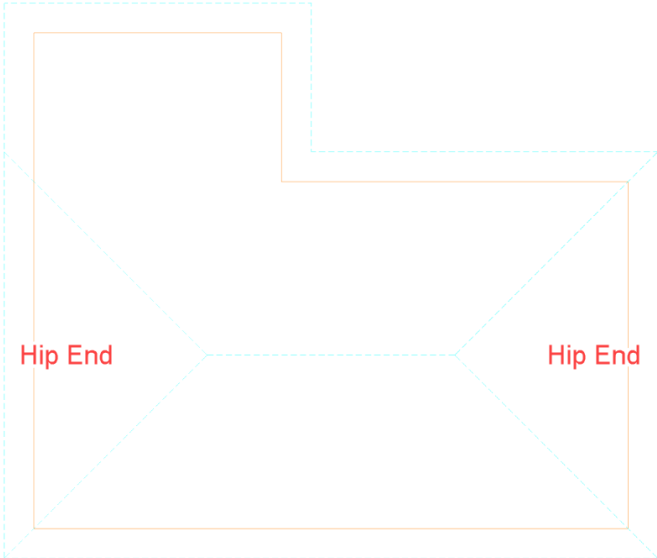

8. Second block:

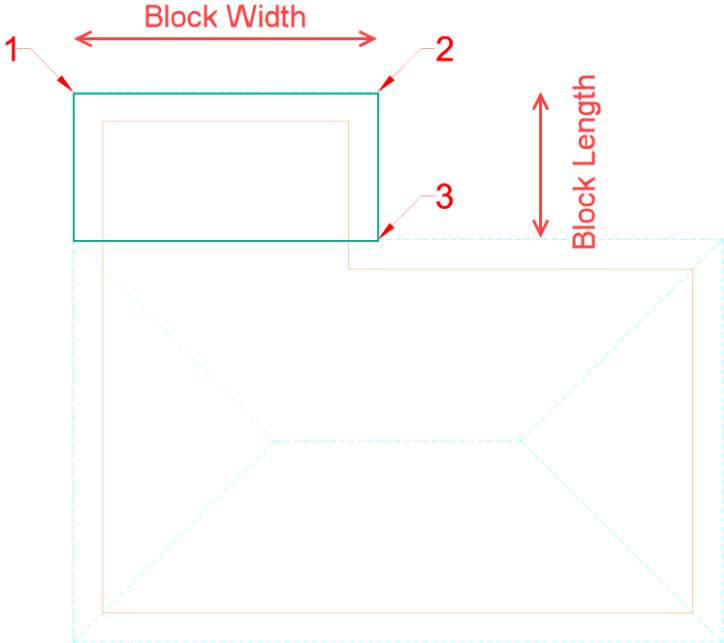

Right click for setup or select first point for roof lines...
Select second point for roof lines...
Select third point for roof lines...

Select Roof Type...Dutch, Hip, Gable, Saddle, GAmbrrel, Boomerang, Radial, Unequal Radial, DOrmer...

Type 'G' for Gable then
'S' for Saddle or
'V' for Valley

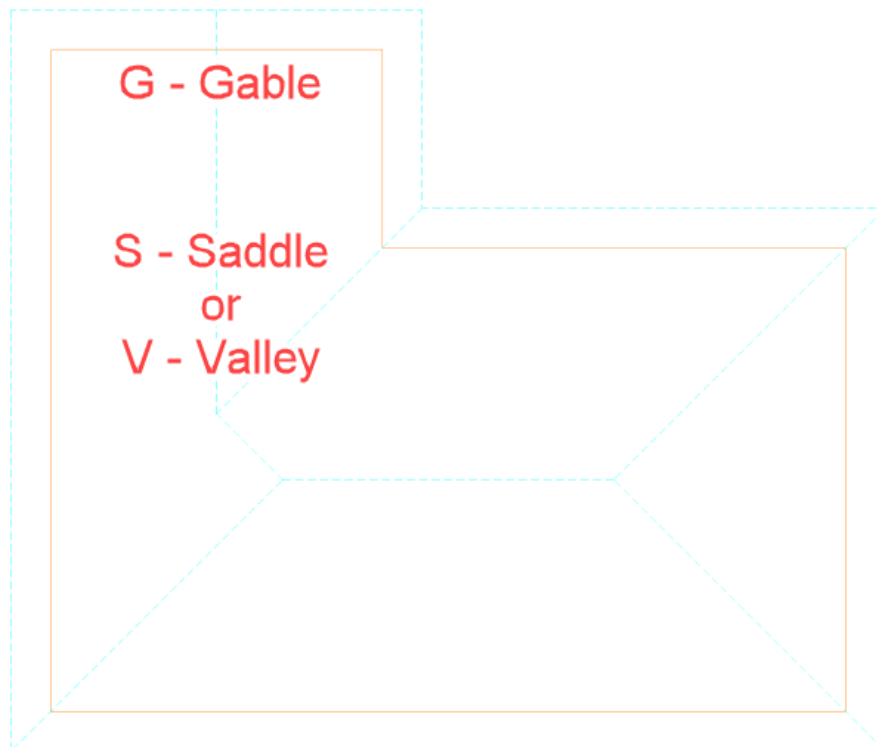

9. Create the Truss Layout using Truss Draw (**TD**) by selecting Roof Blocks on the Support Lines (Orange Lines only) using the same input method as per the Roof Line input. Select the same roof type options as you did for the Roof Line input.

A variety of other roof options are also available when the More (**M**) option is selected.

Cancel
 Command: TD
 Right click for setup or select first point for truss block...
 Select second point for truss block...
 Select third point for truss block...
 Select Roof Type...Dutch, Hip, Gable, Valley, Boomerang, Radial, Dormer, DRopped Valley, More...m

Double click on the option required.

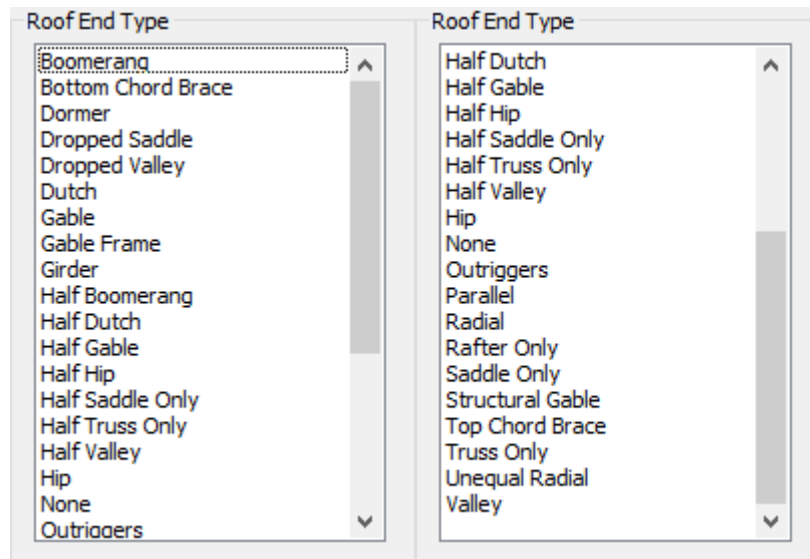

E.g. if the user wishes to create a mono pitch roof using half trusses, type **M** for more options and double click on 'Half Gable' or type **HG** at the Roof Type selection.

If the user wishes to create a raftered roof, type **M** for more options and double click on 'Rafter'.

10. Label the trusses using the **LA** command. This will also add the Truss Design Summary and the layout label text.

11. Manually edit the truss layout as required.

Menu location - Steelwise | Editing:

- **MB** – Member Break. Breaks a truss or multiple trusses into two along a line or cuts back the length of a truss or multiple trusses to a line.
- **C** –Copy.
- **M** –Move.
- **MO** – Member Offset.
- **MR** – Member Reverse
- **SE** – Special Erase, select a single truss then right click to delete all (see Steelwise | Miscellaneous in the menu).

12. If additional trusses need to be inserted, draw a line at the truss location, then create a truss using the **ADD** command to code the line as a truss.

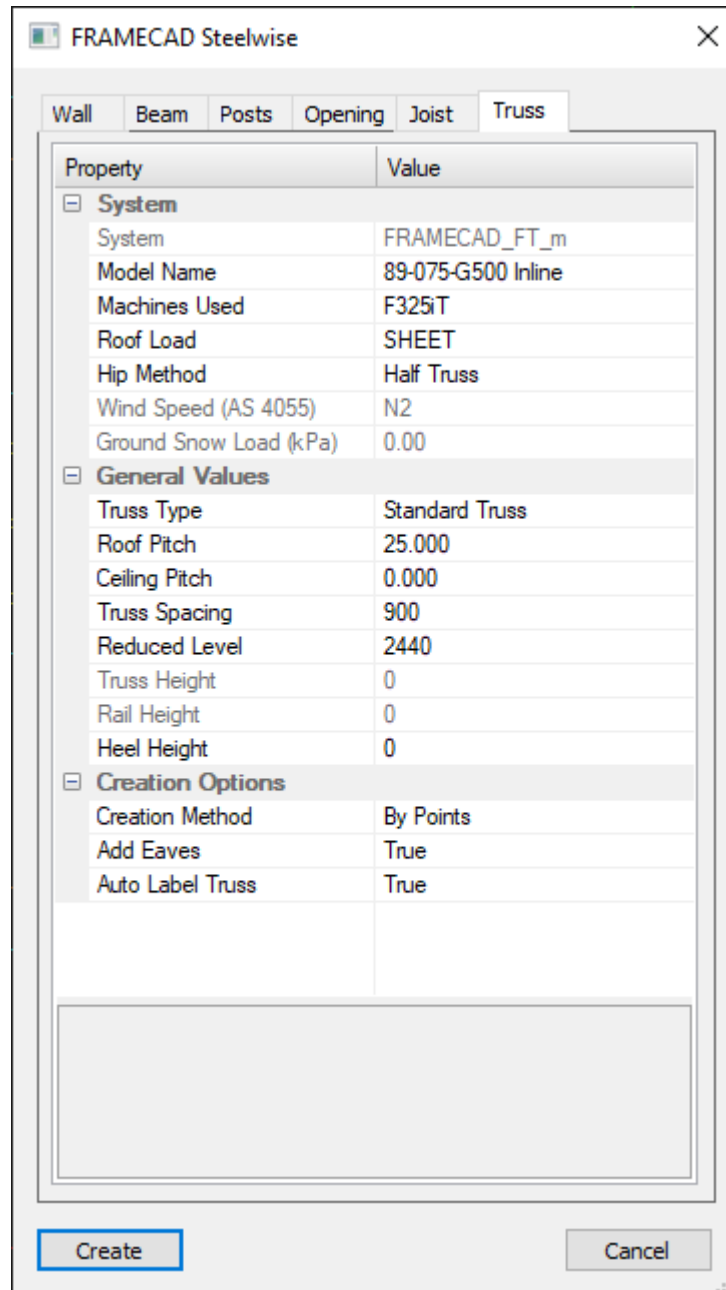

The image shows the 'FRAMECAD Steelwise' dialog box with the 'Truss' tab selected. The dialog contains a table of properties and values, organized into three sections: System, General Values, and Creation Options. At the bottom, there are 'Create' and 'Cancel' buttons.

| Property | Value |
|-------------------------|--------------------|
| System | |
| System | FRAMECAD_FT_m |
| Model Name | 89-075-G500 Inline |
| Machines Used | F325T |
| Roof Load | SHEET |
| Hip Method | Half Truss |
| Wind Speed (AS 4055) | N2 |
| Ground Snow Load (kPa) | 0.00 |
| General Values | |
| Truss Type | Standard Truss |
| Roof Pitch | 25.000 |
| Ceiling Pitch | 0.000 |
| Truss Spacing | 900 |
| Reduced Level | 2440 |
| Truss Height | 0 |
| Rail Height | 0 |
| Heel Height | 0 |
| Creation Options | |
| Creation Method | By Points |
| Add Eaves | True |
| Auto Label Truss | True |

13. To edit a truss after it has been placed, use List (**LI**) to bring up the truss properties.

14. If Auto Label Truss is set to 'False', use the Label (**LA**) command.

15. Insert a secondary Reference Marker (**REF**) in EXACTLY the same place on the building as it was placed on the wall framing layout.

Command: REF

Select point for Secondary or press 'P' for Primary...

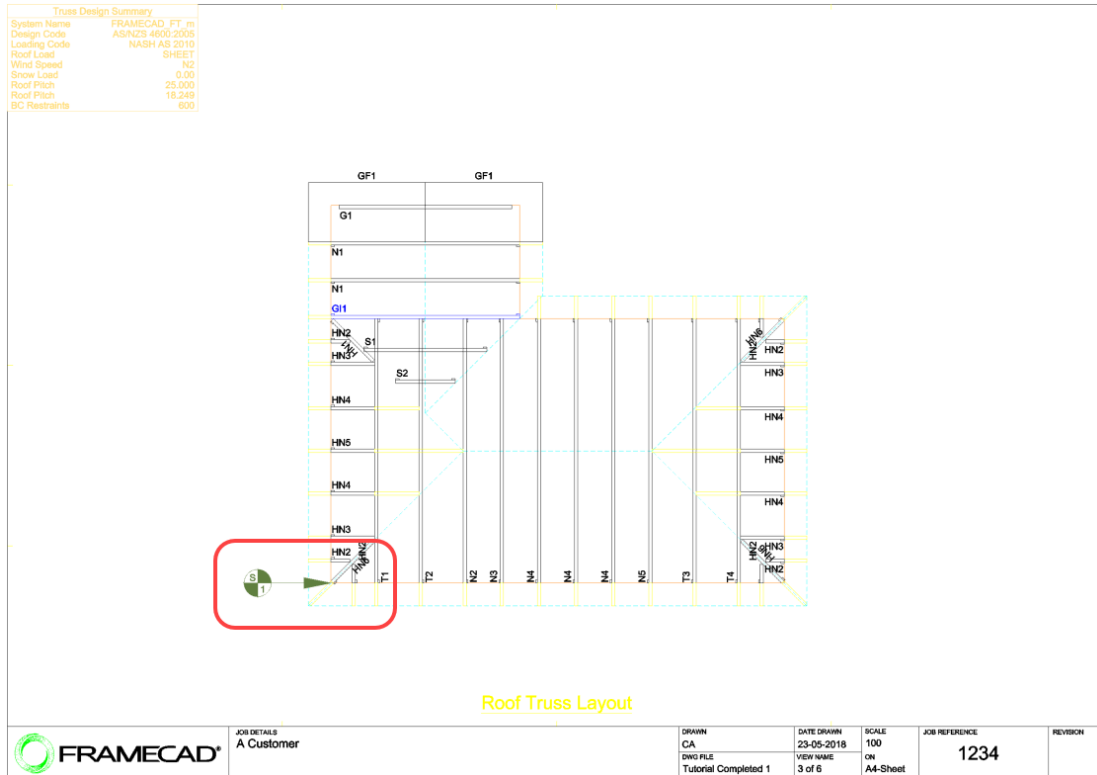

Remember – no part of a reference marker must be outside of a border.

16. Dimension trusses:

- **DO** – Ordinate Dimensions
- **DA** – Aligned Dimensions
- **DH** – Horizontal Dimensions
- **DV** – Vertical Dimensions
- **DM** – Linear Dimensions

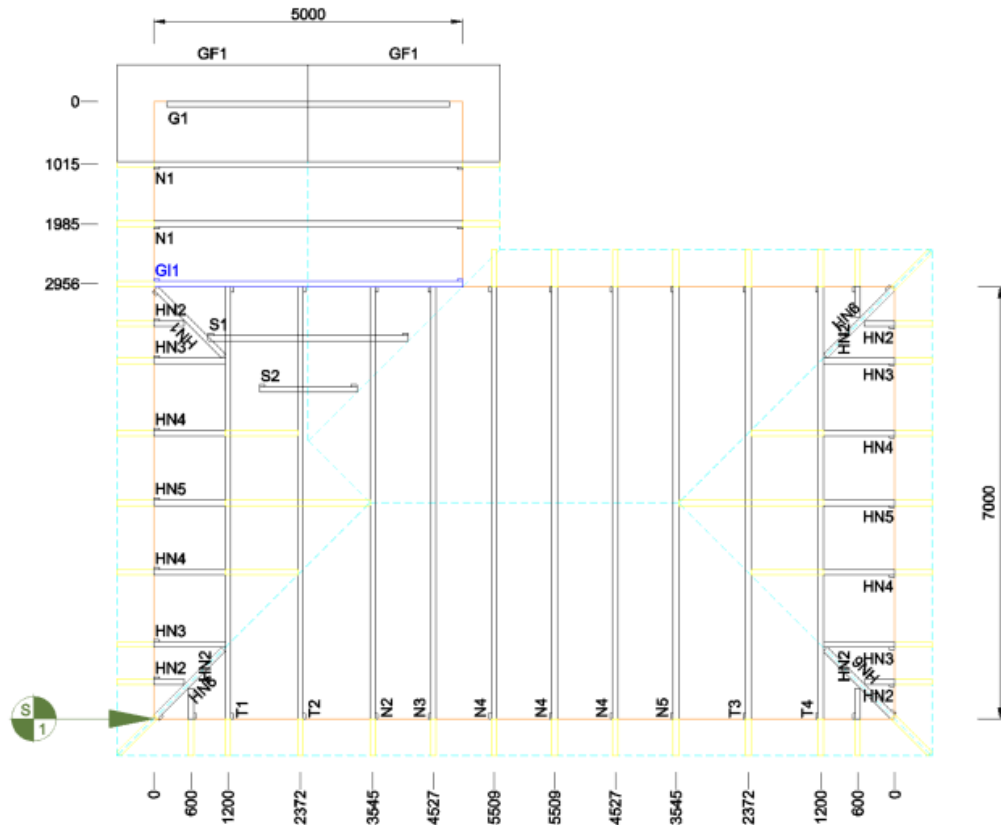

17. Add On-Page Reports as necessary.

- **TOA** – Accessory Summary; lists required accessories.

...SAVE THE JOB...

Alternative Input Option: Use the following procedure for a quick input of pre-defined roof shapes and trusses (this is generally used for demonstration and testing purposes):

- a) Use the Roof Shape Input (**RS**). A dialogue box will appear displaying a number of different pre-defined roof shapes.
- b) Select the required roof shape and change any of the other parameters as required.
- c) Select 'Create'. Length and width of block segments are displayed in the command bar and can be altered by the user at any stage if required.
- d) If 'Include Roof Trusses' has been ticked, the trusses will be placed automatically according to the **TSET** settings and the roof type selected.
- e) Use the Copy Roof (**RCR**) command to copy layout to other borders if required.

4.7 Truss Detailing

1. The trusses should now be exported from Layout space to Truss Detail space through the Truss Builder (**TTD**). From within the Truss Builder you can check individual truss fabrication elevations, bill of materials reports, engineering diagrams and engineering results and scan through the trusses before exporting.

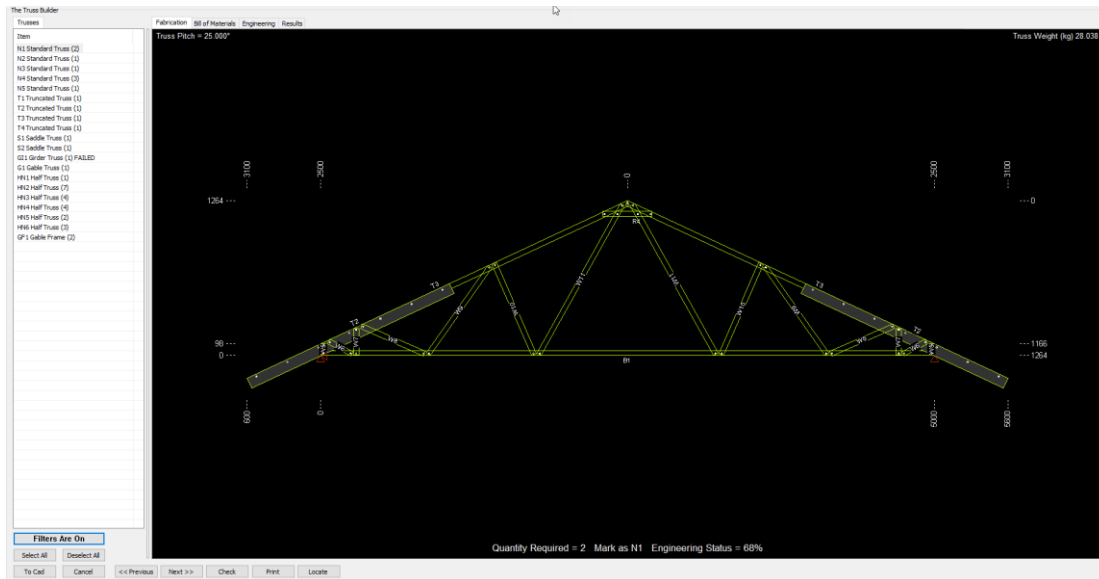

2. Double click on the truss name in the left-hand column of the Truss Builder to edit any parameters if required.

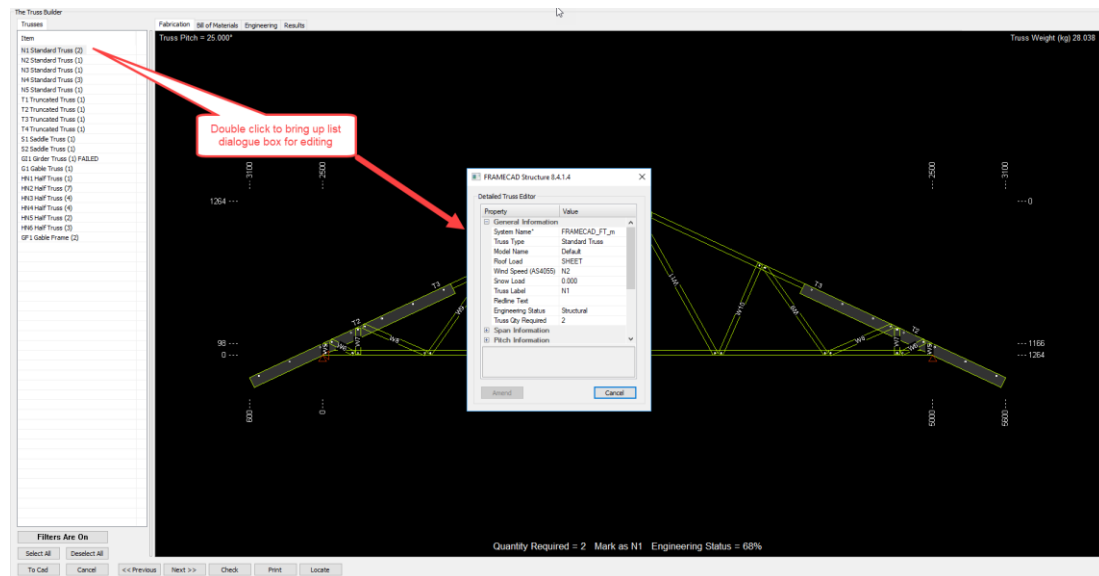

3. Click on 'Select All' and then 'To CAD' to export trusses. A new Detailing space tab is created labelled 'Truss.1'.

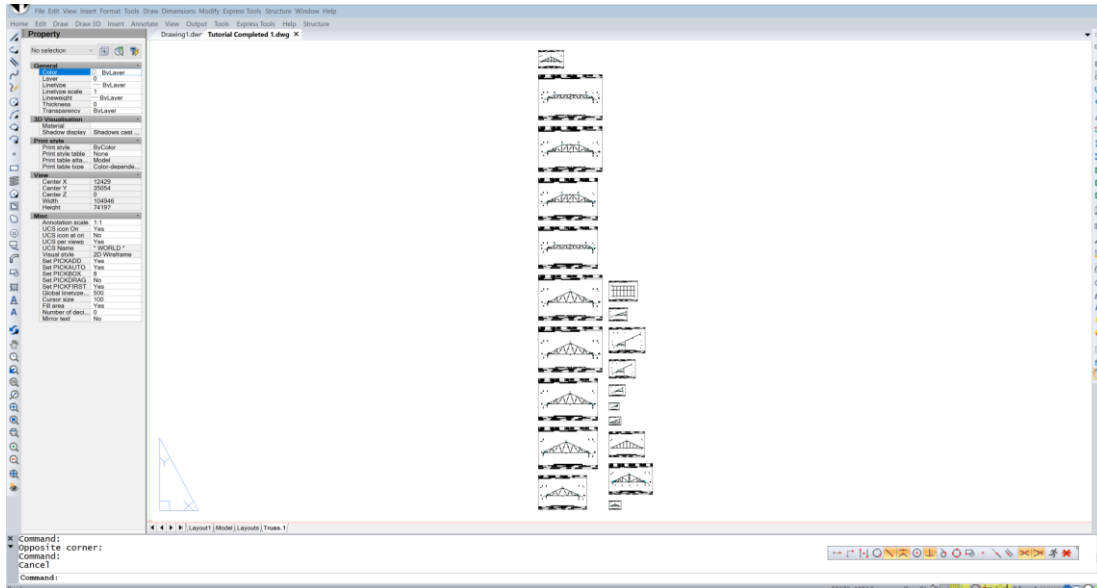

4. Check all detailed trusses as required:
 - View Restore (**VR**) to view first drawing.
 - Next View (**VV**) to scroll through drawings.

Note: To find a specific truss use **FIND**.

- If a truss fails, more information can be obtained in the Truss Builder (**TTD**). Ensure the truss is centred on the screen first. Type '**V**' then the truss border number to centre it.

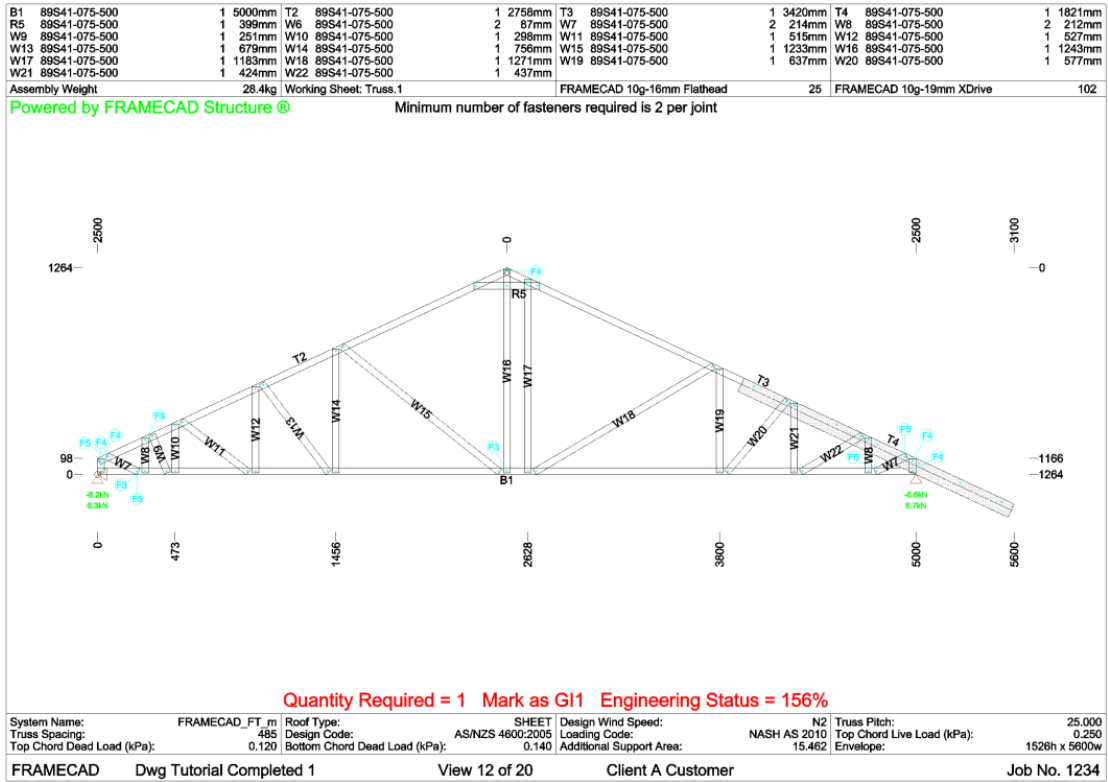

- To see where the member is failing, click on the 'Engineering Off' button on the top right corner of the Truss Builder. This will then change to 'Engineering On' and coloured lines indicating engineering results will be superimposed over the truss. Any red lines indicate where the member failures occur.

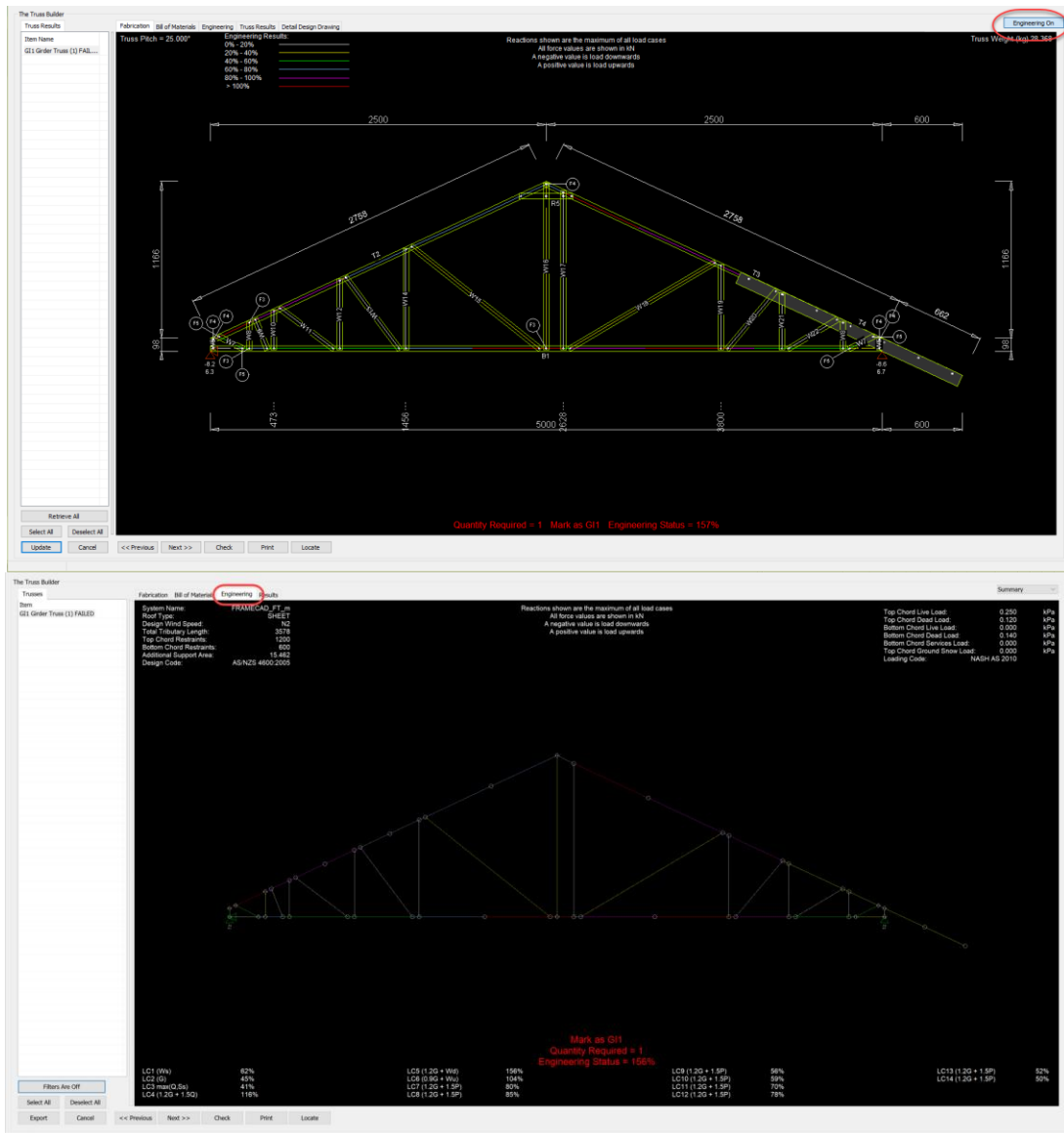

- Some parameters can be modified by double clicking on the truss name in the left column of the Truss Builder. Make changes, Amend, and then Update.

8. Use the following commands as required for editing:

Menu location - Steelwise | Trusses | Detail

- **AS** – Add Support. **Escape** or **Enter** to automatically re-engineer.
- **BM** – Box Member. Automatically updates engineering. Hold 'Alt' to add reinforcing member in LC (wide axis) orientation.

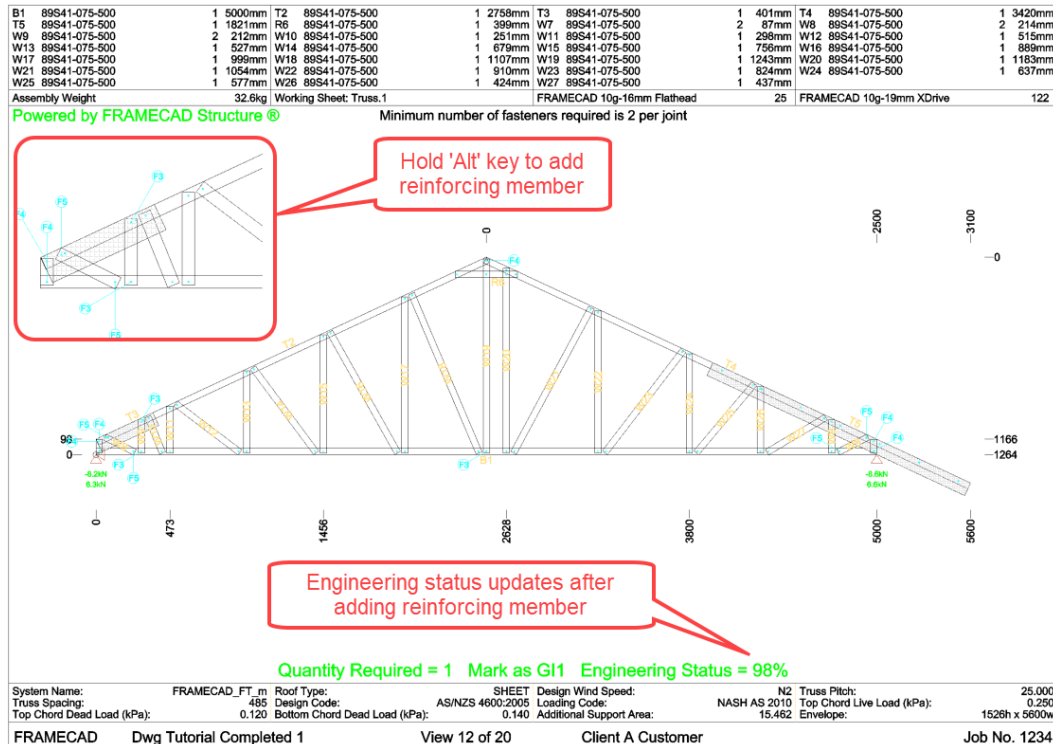

- **ADD or CM** – Code Member. Code a line as a chord, web or rail. Automatically updates engineering.
- **IW** – Insert Web. For inserting webs. Automatically updates engineering.
- **TPL** – Truss Point Load. For adding a specific point load to a truss. Automatically updates engineering.

Menu location - Steelwise | Editing

- **MB** – Member Break. Breaks a member or multiple members into two along a line or cuts back the length of a member or multiple members to a line.
- **C** – Copy
- **ME** – Extend
- **IP** – Inherit Properties
- **MJ** – Join. Joins contiguous members together
- **M** – Move
- **MC** – Member Cut. Cuts a member into two at a specified point. Hold 'Alt' to splice truss members in detailing view.
- **MI** – Mirror
- **ML** – Member Lengthen. Lengthens or shortens member by a given amount. Enter the distance, select the member or members, right click to activate change.
- **MR** – Member Reverse

- **MS** – ReSquare Member. Also updates fasteners. Select one web member to update whole truss.
- **MO** – Offset

Menu location - Steelwise | Miscellaneous

- **LI** – List Truss Properties - Change Truss Rotation, Steel type and Reports.
- **SE** – Special Erase. For deleting webs.

Menu location - Steelwise | Trusses

- **TTD** to go back to the Truss Builder then click on 'Update' to re-engineer

OR

- **-TTD** to re-engineer in place in the detail space without going to the Truss Builder.

9. **REP** - View, Print or Export a csv from the Truss Usage Report (options included are various material summary reports and Engineering Status).

10. **RFY** - Create FRAMECAD RFY machine file.

11. Go back to Layout.

12. **REP** - View, Print or Export a csv from the Truss Layout Report (options included are Truss Accessories, Engineering Status and Truss Uplift Reactions)

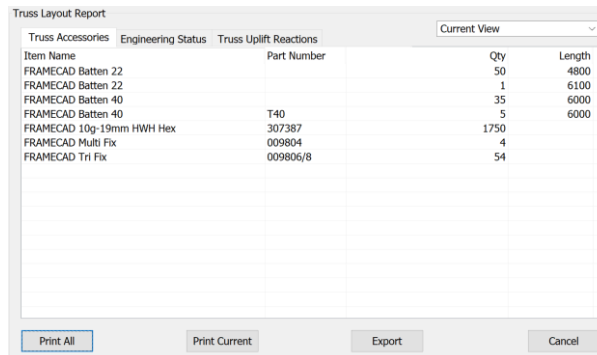

| Item Name | Part Number | Qty | Length |
|---------------------------|-------------|------|--------|
| FRAMECAD Batten 22 | | 50 | 4800 |
| FRAMECAD Batten 22 | | 1 | 6100 |
| FRAMECAD Batten 40 | | 35 | 6000 |
| FRAMECAD Batten 40 | T40 | 5 | 6000 |
| FRAMECAD 10g-19mm HWH Hex | 307387 | 1750 | |
| FRAMECAD Multi Fix | 009804 | 4 | |
| FRAMECAD Tri Fix | 009806/8 | 54 | |

13. **TUP** - Create a Truss Uplift Plan. Ensure the **truss plan** is centrally located on the screen. Start the command then click within the destination border.

| Applied Load Summary | | All uplift values UNO are shown in kN Only values over 1.0kN are shown All other values are ignored | |
|----------------------|-------------------------|---|--|
| Loading Code | NASH AS 2010 | | |
| Wind Speed (AS4055) | N2 | | |
| Snow Load (kPa) | 0.000 | | |
| SHEET | Roof Live Load (kPa) | 0.250 | |
| | Colling Live Load (kPa) | 0.500 | |
| | Roof Dead Load (kPa) | 0.120 | |
| | Roof Ceiling Load (kPa) | 0.140 | |
| | Services Load (kPa) | 0.000 | |
| | Design Point Load | 1.100 | |
| | Suspended Ceiling | No | |
| | Shuttered Conditions | No | |

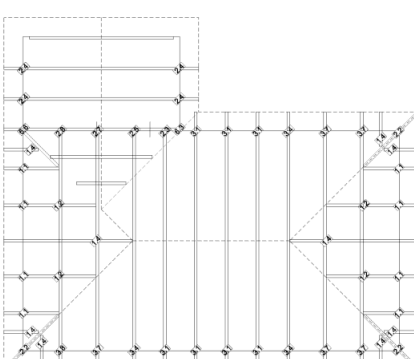

Truss Uplift Plan

| JOB DETAILS | | DRAWN | DATE DRAWN | SCALE | JOB REFERENCE | REVISION |
|-------------|--|----------------------|------------|----------|---------------|----------|
| A Customer | | CA | 23-05-2018 | 100 | 1234 | |
| | | PROCESS | VIEWNAME | ON | | |
| | | Tutorial Completed 1 | 6 of 6 | A4-Sheet | | |

14. **A3D** – To generate 3D frames. This is placed in the 'Model' space. Use **A3D** for all built job frames or **T3D** for built trusses only.

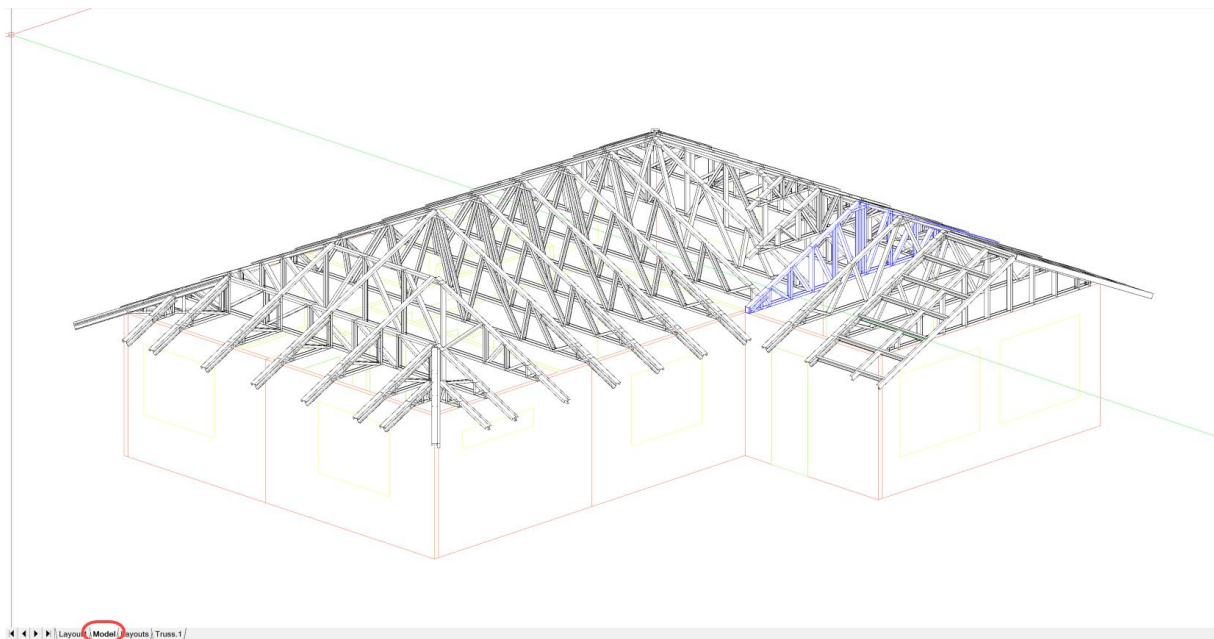

15. **VV** – To toggle through the pre-set 3D views.
 16. Go to View | Visual Styles in the menu and select '3D Hidden'.
 17. **A3D** again to turn off 3D frames.

...SAVE THE JOB...

4.8 Floor Joist Input

1. Pre-requisite: Lower and upper wall frame layouts completed.
2. Make sure there is a Layout space border for the joist layout, if not, add it using **BSET** – increase the border quantity.
3. As a preliminary check to establish the required depth, spacing and material usage of webbed joists, you can go to the FRAMECAD Joist-Calc on MyFRAMECAD website.

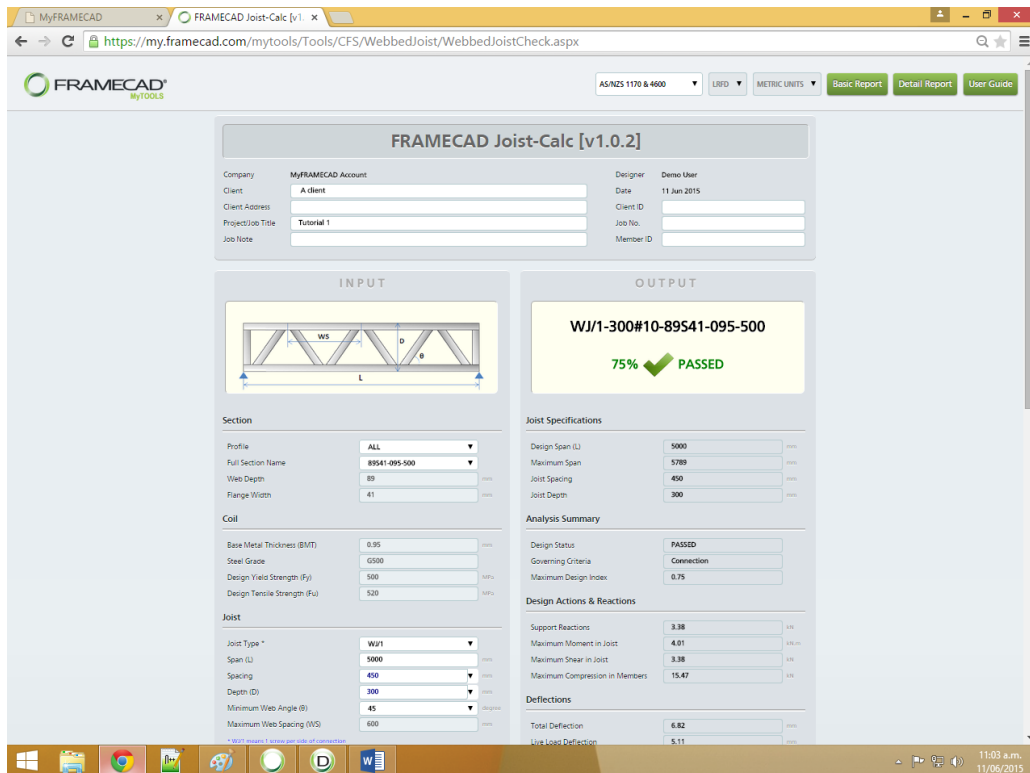

FRAMECAD Joist-Calc [v1.0.2]

Company: MyFRAMECAD Account | Designer: Demo User
 Client: A client | Date: 13 Jun 2015
 Client Address: | Client ID: |
 Project/Job Title: Tutorial 1 | Job No.: |
 Job Note: | Member ID: |

INPUT

Diagram labels: WS, D, L

Section

Profile: ALL
 Full Section Name: 89541-095-500
 Web Depth: 89
 Flange Width: 41

Coil

Base Metal Thickness (BMT): 0.95
 Steel Grade: G550
 Design Yield Strength (Fy): 500
 Design Tensile Strength (Fu): 520

Joist

Joist Type: WJ1
 Span (L): 5000
 Spacing: 450
 Depth (D): 300
 Minimum Web Angle (B): 45
 Maximum Web Spacing (WS): 600

OUTPUT

WJ/1-300#10-89541-095-500
 75% **PASSED**

Joist Specifications

| | |
|-----------------|------|
| Design Span (L) | 5000 |
| Maximum Span | 5789 |
| Joist Spacing | 450 |
| Joist Depth | 300 |

Analysis Summary

| | |
|----------------------|------------|
| Design Status | PASSED |
| Governing Criteria | Connection |
| Maximum Design Index | 0.75 |

Design Actions & Reactions

| | |
|--------------------------------|-------|
| Support Reactions | 3.38 |
| Maximum Moment in Joist | 4.01 |
| Maximum Shear in Joist | 3.38 |
| Maximum Compression in Members | 15.47 |

Deflections

| | |
|----------------------|------|
| Total Deflection | 6.82 |
| Live Load Deflection | 5.11 |

Otherwise, after step 10, you can draw a joist in Steelwise using the ADD command and alter the parameters to suit the worst-case scenario to establish your joist materials, spacing and depth.

4. Go to **JSET** and ensure the **System Name** is correct.

| Property | Value |
|------------------------------|----------------|
| Member Information | |
| System Name* | FRAMECAD_FT_m |
| Model Name | Select |
| End Bearer Type* | None |
| Int Bearer Type* | None |
| Side Bearer Type* | WJ89095 |
| Joist Type* | WJ89095 |
| Member Height Override | 300 |
| Layouts Information | |
| Joist Spacing | 600 |
| Int Bearer Spacing | 3000 |
| Ceiling Batten Spacing | 600 |
| Reduced Level | 2740 |
| Bearers Method | Bearers Inline |
| Inline Int Bearers | False |
| Double Int Bearers | True |
| Oncoming Web Align | True |
| Double Webs to Supports | False |
| Applied Loads | |
| Deflection Limit | |
| Ceiling Battens Information | |
| Creation Options | |
| Report Options | |
| Labelling Option Information | |

Save Cancel

5. Select the required **Model Name**. 'C' = Deep C Joists. 'WJ' = Webbed Joists. Once a model has been selected, some of the joist/bearer types will automatically be populated.
6. Add or modify any Bearer and Joist types to suit.

End Bearer Type: By default, these members sit on the perimeter of the floor layout and are perpendicular to the joists.

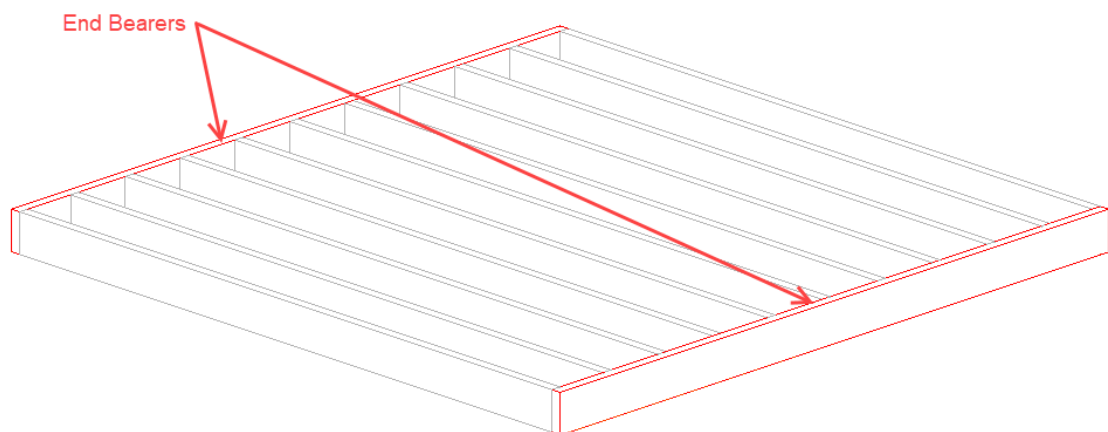

Int Bearer Type: These members are perpendicular to, and located somewhere between the ends of the joists at a pre-determined spacing as selected in the 'Layouts Information'.

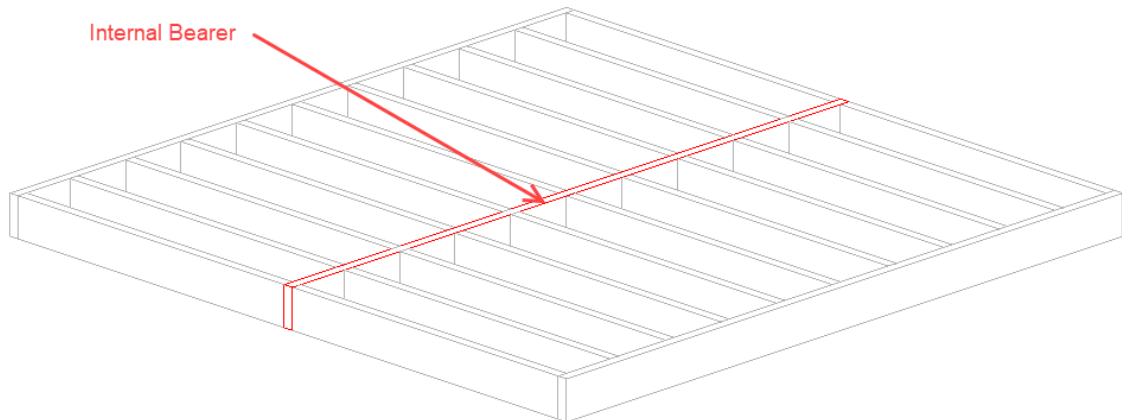

Side Bearer Type: By default, these members sit on the perimeter of the floor layout and are parallel to joist layout. Generally these members will be sitting along walls below.

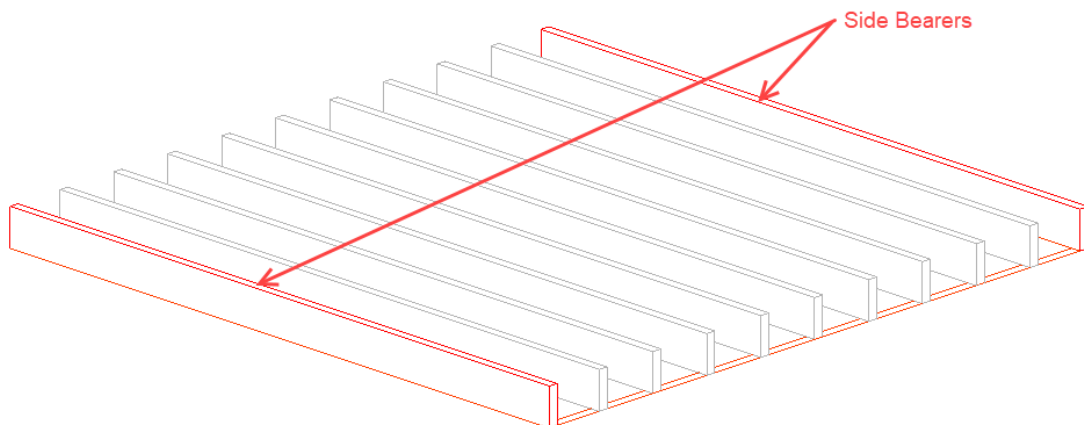

Joist Type: These are the standard joists which support the floor only.

7. For webbed joists, edit the **Member Height Override** to suit the required floor joist depth.
8. Set all the parameters in the **Layouts Information** section as outlined below:
 - **Joist Spacing** – joist spacings from centre to centre. The location of the first joist is from the outside of the Side Bearer to the centre of the joist.
 - **Int Bearer Spacing** – only relevant if the Internal Bearer Type is selected in the Member Information.
 - **Ceiling Batten Spacing** - determines the bottom chord restraint spacings.
 - **Floor Datum** - the height from the bottom of the building to the top of the joists.

- **Bearers Method** (End Bearers Only – ‘End Bearer Type’ must be selected):
 - o ‘Bearers Inline’ if the end bearers are within the joist space.
 - o ‘Bearers Under’ if the end bearers are below the joists, i.e. the joists are sitting on top of the bearers.
 - o ‘Blocking’ if blocking members are required between the ends of the joists.
- **Inline Int Bearers** (‘Int Bearer Type’ must be selected) - determines whether internal bearers are within the joist space or below the joists.
- **Double Int Bearers** - determines whether the internal bearer members are double or single members.
- **Oncoming Web Align** – places vertical webs in line with any oncoming members for fixing purposes.
- **Double Webs to Supports** – places two vertical members inside each edge of a support line of a pre-defined width.

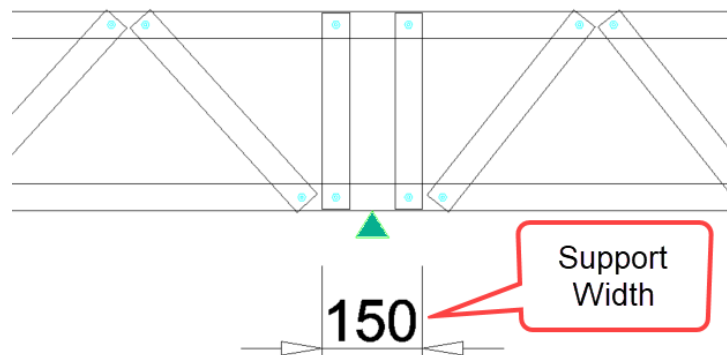

To apply a width to a support line, list (LI) the support line and change the ‘Support Line Data’ parameters to suit (see below).

9. **Support Line Data** (Support Line Editor - listing a support line)

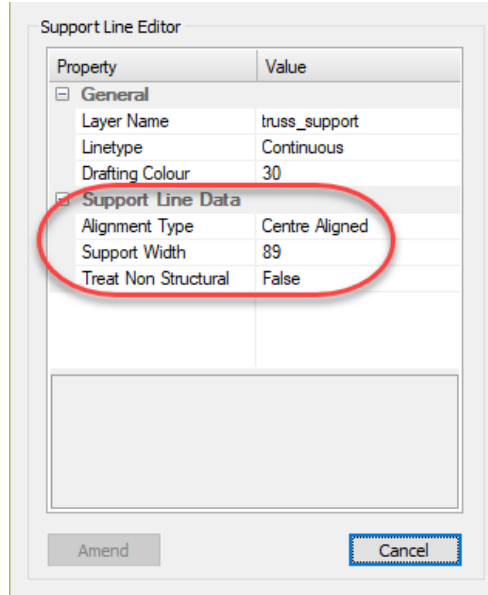

| Property | Value |
|--|----------------|
| <input type="checkbox"/> General | |
| Layer Name | truss_support |
| Linetype | Continuous |
| Drafting Colour | 30 |
| <input type="checkbox"/> Support Line Data | |
| Alignment Type | Centre Aligned |
| Support Width | 89 |
| Treat Non Structural | False |

Amend Cancel

- Alignment Type:
 - Edge Aligned – applies a width from the outside edge of a support line that sits at the end of the floor joists.
 - Centre Aligned – applies a width from the centre of the support line that is located anywhere along the length of the floor joists.
 - End Fixed – applies a support to the top chord of the joist for when joists are end fixed into the side of another member, beam or wall.
 - Auto – determines whether the support line should be edge or centre aligned based on its location within a joist layout.
- Support Width – Total width of the supporting member under a joist. End Fixed alignment type would be set to '0' width. See also '**Double Webs to Supports**' above.
- Treat Non Structural – 'False' will place a support point on the joist and also place a vertical web in the same location. 'True' will place a vertical web but no support point.

10. Consult your local engineer for **Applied Loads** and **Deflection Limit** values.

11. Use **Polyline (P)** to trace the outline of the lower level walls on the wall layout plan.

12. Move the outline into the Joist Layout border.

13. Use **Polyline (P)** to trace the outline of the upper level floor area to include all joists in logical blocks according to joist direction, etc. Include any polylines that define stairwell openings or voids.

14. Move these polylines into the Joist Layout Border so that it super-imposes over the ground level polylines.

15. Repeat the polyline input procedure on subsequent areas of the building according to its complexity.

16. Use the **Create Support Line (CSL)** command to create support lines based on the centreline of selected walls and beams from the lower wall framing plan that supports the floor.
17. Edit support lines by listing (**LI**) them and modifying the parameters as outlined in the '**Support Line Data**' in item 8 above.
18. Input joists (**JD**) by selecting the polylines (or all sides of a block if not a polyline) including any stairwell opening polylines.
19. You will then be asked for the floor setout point and direction of the joists.

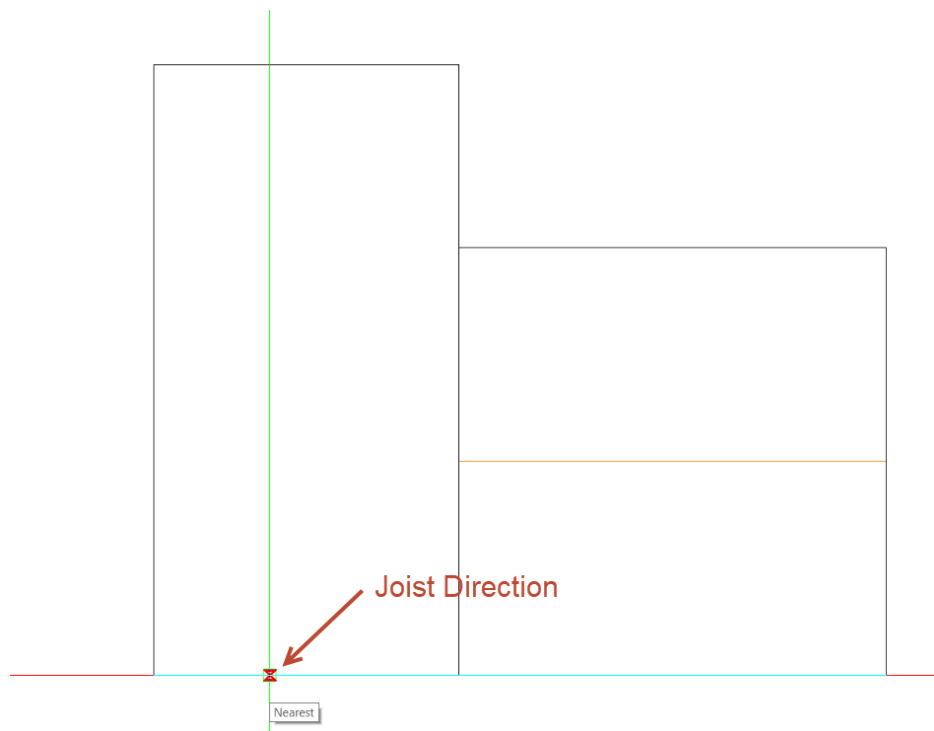
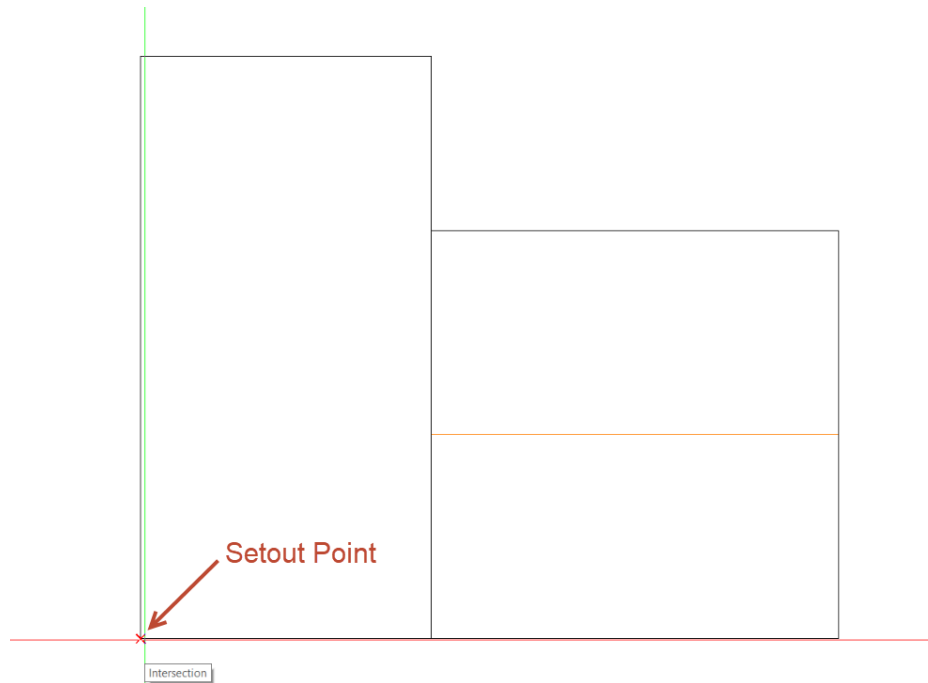

20. Repeat previous step until all joists are placed.
21. Use **ADD - Joist** to input individual members if required.

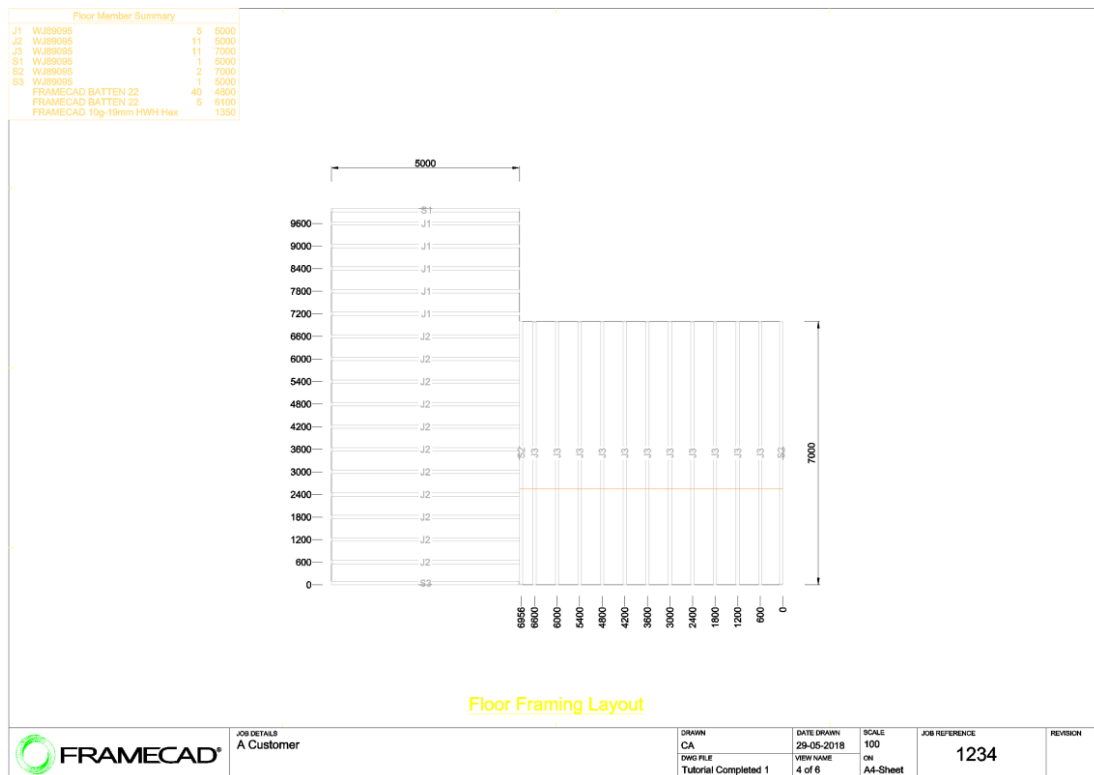

22. The start end (left-hand end) of a joist as viewed in elevation (Detail Space) is indicated with an arrow.

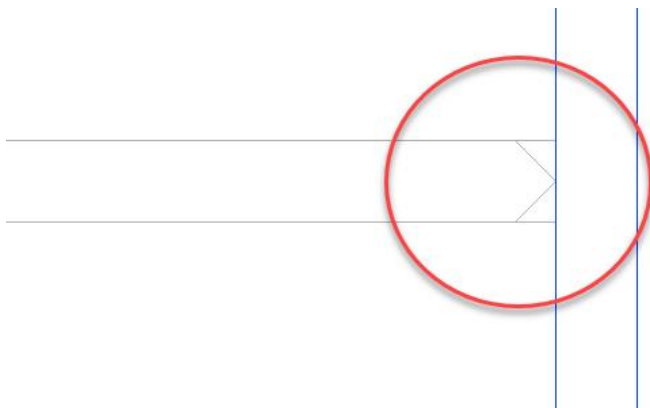

23. If any editing is required you can use the Editing commands in the Steelwise menu.
24. By default, joists will auto label on input. This option can be turned off in JSET – Creation Options.
25. If any editing has been carried out, joists may need to be relabelled using either the LA or JLA command.

4.9 Floor Member Usage for Engineering

1. In the next stage of the process you may need to change the joist **Member Usage** according to its location in the building.

First, you need to determine what is supporting the joists and what is being supported by other members.

When you list (LI) a member, the drop-down list associated with the 'Member Usage' has the following options: **End Bearer, Side Bearer, Internal Bearer, Joist, Joist Beam and Beam Bearer.**

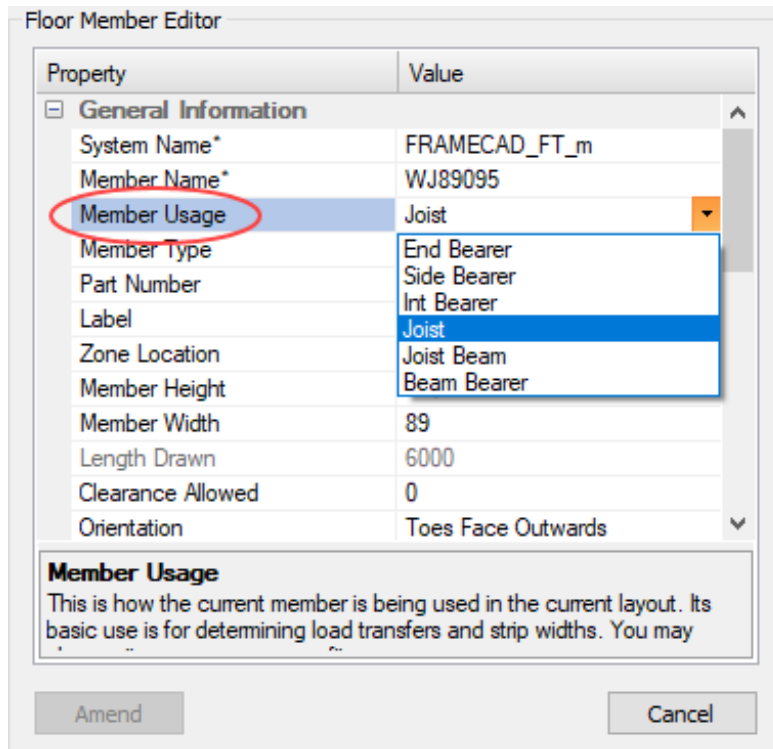

| Property | Value |
|----------------------------|--------------------|
| General Information | |
| System Name* | FRAMECAD_FT_m |
| Member Name* | WJ89095 |
| Member Usage | Joist |
| Member Type | End Bearer |
| Part Number | Side Bearer |
| Label | Int Bearer |
| Zone Location | Joist |
| Member Height | Joist Beam |
| Member Width | Beam Bearer |
| Length Drawn | 89 |
| Clearance Allowed | 6000 |
| Orientation | 0 |
| | Toes Face Outwards |

Member Usage
This is how the current member is being used in the current layout. Its basic use is for determining load transfers and strip widths. You may

Amend Cancel

- **End Bearer** – does not support any other members (non-structural).
- **Side Bearer** – does not support any other members (non-structural).
- **Internal Bearer** – does not support any other members (non-structural).
- **Joist** – does not support any other members (structural).
- **Joist Beam** – this is a joist that supports other joists. See example below.

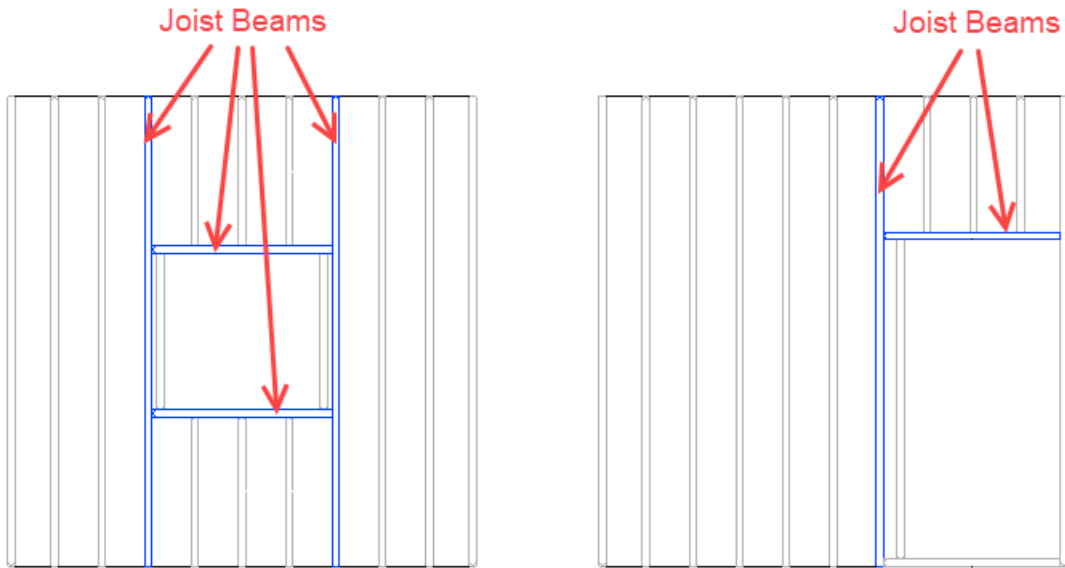

Beam Bearer – this is defined as an End Bearer that supports Joists and Joist Beams, but spans between two or more supports, whereas an End Bearer is continuously supported. See examples below.

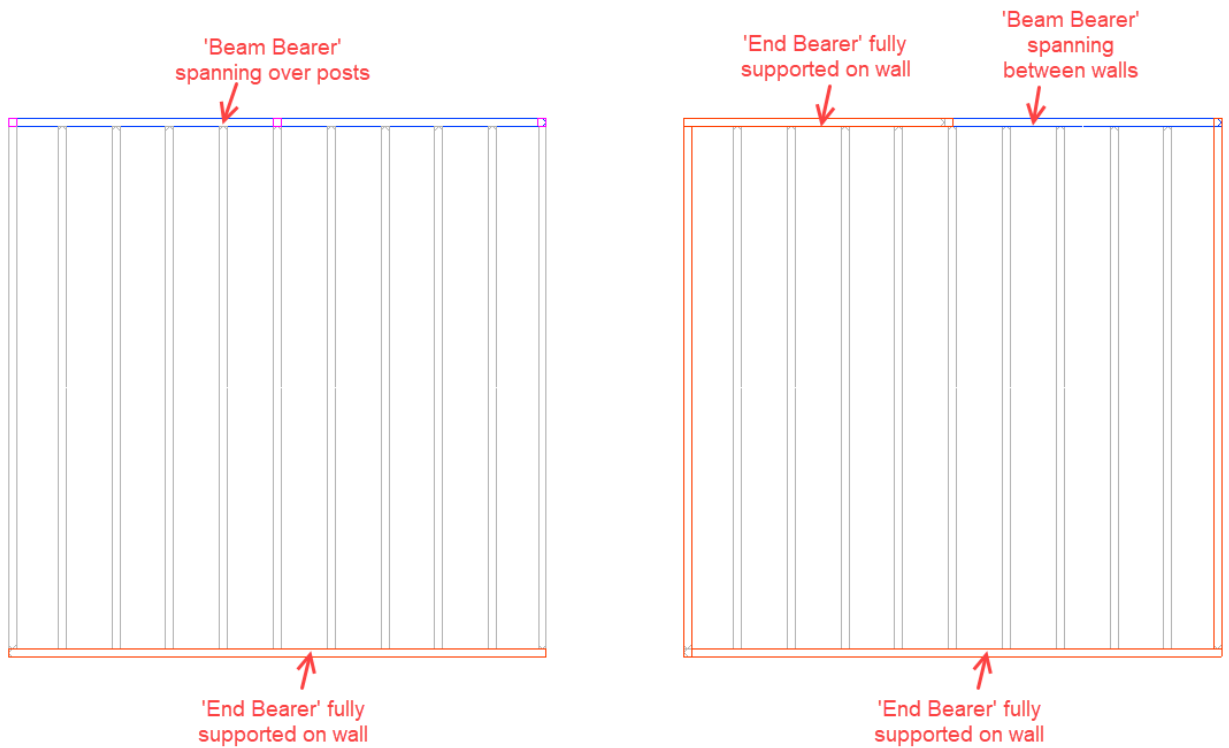

In the second example above, the End Bearer has been split into two members, so the unsupported portion can be defined as a Beam Bearer.

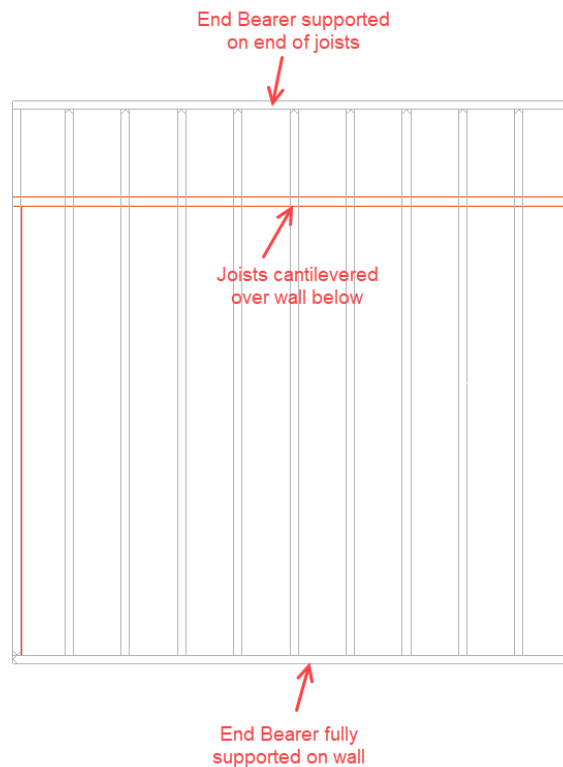

In the example above, the member on the cantilevered end of the joists will remain as an End Bearer because it is supported by the joists.

1. Check joists – **IC** (Integrity Check)
2. If the joist auto labelling is turned off, label the joists using either the **LA** or **JLA** command.
3. If any editing has been carried out, joists may need to be relabelled.
4. View, Print or Export a csv from the Floor Layout Report – **REP** (options included are Member, Sheet, Batten and Accessories Reports).
5. Insert a Secondary Reference Marker (**REF**) at the same location on the Floor Framing Layout as the Primary Reference Marker sits in the Wall Framing Layout.

...SAVE THE JOB...

4.10 Floor Joist Engineering

Joist engineering results can only be accessed from the Joist Builder, which is only accessible by using the **JJD** command from the layout plan. From here you can view/export/print any required engineering information. Unlike trusses, joists modified in the elevation view cannot be re-engineered.

Note: Any manual modifications made to joists in the detail (elevation) view will void any engineering results. Engineering results are only valid using JJD from the initially detailed joists on the layout plan. Any joist modifications should be checked by an engineer.

4.11 Floor Joist Detailing

1. If deep 'C' joists are being detailed, the RFY file must be created directly from the layout using the RFY command. You do not need to build these joists, therefore, the JJD step is not required for this process.
2. If webbed joists are being detailed, these need to be exported from Layout space to Detail space through the Joist Builder (**JJD**).
3. Check joists using Next and Previous options or by clicking on the Check button to auto scroll through them.
4. Click on 'Select All' and then 'To CAD' to export the joists. A new Detail space tab is created labelled 'Floor.x'.
5. Check all detailed joists as required:
 - View Restore (**VR**) to view first drawing.
 - Next View (**VV**) to scroll through drawings.
6. Editing commands can be used on the joists members if required.
7. View, Print or Export a csv from the Floor Usage Report – **REP**
8. Create the FRAMECAD RFY machine file (**RFY**).
9. Go back to the 'Layout' space.
10. Dimension joists as required:
 - **DO** - Ordinate Dimensions
 - **DA** - Aligned Dimensions
 - **DH** - Horizontal Dimensions
 - **DV** - Vertical Dimensions
 - **DM** – Linear Dimensions
11. Add Accessory Report (**JOA**) if required.

| Panel Accessories | |
|--------------------------|-----|
| FRAMECAD 10g-19mm XDrive | 440 |
| FRAMECAD Tri Fix | 55 |

...SAVE THE JOB...

12. You can now go to the next stage of wall panel detailing now that the joist are detailed and the loads can be transferred.

4.12 Final Wall Panel/Beam Design

Note: Make sure the truss and floor layouts have been completed before proceeding with this stage of the Wall Detailing Process as roof and floor loads must be applied to the walls (see Truss Detailing Process and Floor Joist Detailing Process).

Note: bracing should not be inserted until the 'Reference Points' stage is complete. This is because for the bracing calculations to be accurate, the applied loads must all be known.

1. Once the truss and floor joist detailing has been completed, the following procedures can then be undertaken.
2. In the 'Wall' Detail space, select View 2 - the Framing Layout. To do so type 'V' Enter, '2' Enter.
3. Ensure that the reference markers are in place – **REF**.
4. Correct panels over maximum length using Member Cut (**MC**) at internal walls where possible, or between openings when no internal walls exist. For accurate wall engineering, it is important to break walls to suit the load types and locations from above.
5. Panel Calculate Brace (**PCB**) to see how much bracing is required in each direction. Look at the 'Shortage X and Y' figures. **Note: Always ensure the wall framing plan being calculated is in focus on the screen when using this command.**
6. If the 'Shortage X and Y' values are less than the 'Wind Force X and Y' values, this usually means that there are other bracing options selected. Go to 'Bracing Options' and select or de-select whatever is or is not required.

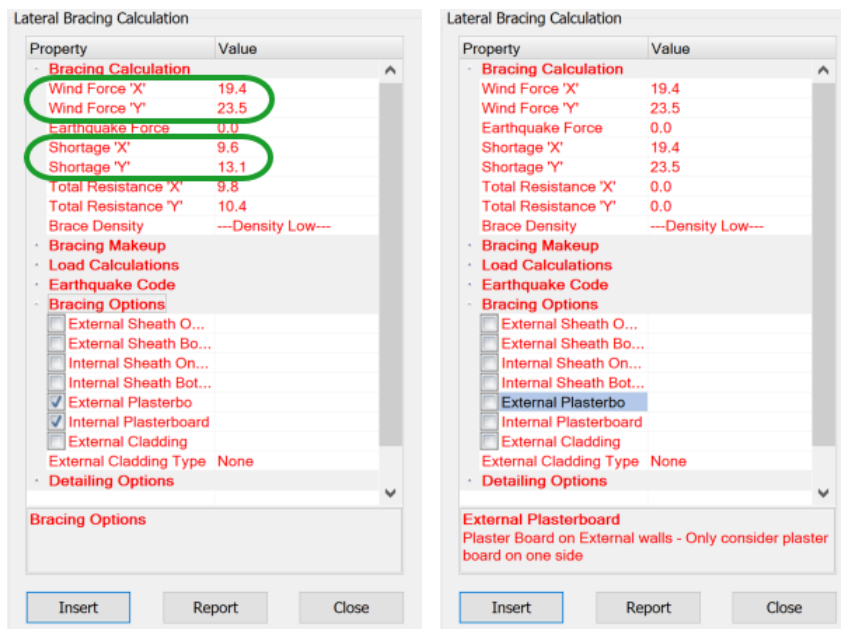

- Click on 'Insert Brace' or use the command - Panel Insert Brace (**PIB**) to insert braces. Return for Setup to set required Brace Type. Check **PCB** periodically to see remaining number of bracing requirements in each direction. Add more bracing until the 'Shortage' figures read zero in both the 'X' and 'Y' directions.

Lateral Bracing Calculation

| Property | Value |
|--------------------------|------------------|
| · Bracing Calculation | |
| Wind Force 'X' | 19.4 |
| Wind Force 'Y' | 23.5 |
| Earthquake Force | 0.0 |
| Shortage 'X' | 0.0 |
| Shortage 'Y' | 0.0 |
| Total Resistance 'X' | 19.4 |
| Total Resistance 'Y' | 24.1 |
| · Bracing Makeup | |
| · Load Calculations | |
| Design Code | AS/NZS 4600:2005 |
| Current View | 2 |
| Wind Speed (AS4055) | N2 |
| Wall Area 'X' | 14.520 |
| Wall Area 'Y' | 11.991 |
| Roof Area 'X' | 10.971 |
| Roof Area 'Y' | 9.060 |
| Brace Density 'X' | 4910 |
| Brace Density 'Y' | 3320 |
| · Earthquake Code | |
| · Bracing Options | |
| · Detailing Options | |
| Detailing Options | |

8. To create a Bracing and Racking Resistance Plan, ensure that the Wall Layout Plan is in focus on the screen, then re-activate Panel Calculate Brace (**PCB**). In the PCB form, go to Detailing Options and select 'Create Bracing Plan' then click on 'Insert'. The plan will zoom to extents to display all the borders, then select an empty border to create the bracing plan in.

Lateral Bracing Calculation

| Property | Value |
|---|-------|
| - Bracing Calculation | |
| Wind Force 'X' | 19.4 |
| Wind Force 'Y' | 23.5 |
| Earthquake Force | 0.0 |
| Shortage 'X' | 0.0 |
| Shortage 'Y' | 0.0 |
| Total Resistance 'X' | 19.4 |
| Total Resistance 'Y' | 24.1 |
| - Bracing Makeup | |
| - Load Calculations | |
| - Earthquake Code | |
| - Bracing Options | |
| - Detailing Options | |
| <input type="checkbox"/> Insert Wind Force ... | |
| <input type="checkbox"/> Insert Racking Res... | |
| <input checked="" type="checkbox"/> Create Bracing Plan | |

Create Bracing Plan

Insert Report Close

9. These plans are automatically titled.
10. Switch back to View 2.
11. Integrity Check (**IC**) to ensure no problems exist.
12. Panel Build Studs (**PBS**) if stud locations need to be updated at any stage.
13. Panel Update All (**PUA**) if walls need to be re-engineered at any stage. See section 2.4 for the various panel engineering setting options that are available in BSET.
14. Add On-Page Reports as necessary.
 - **OR** – Design Report
 - **POS** – Panel Summary
 - **POB** – Beam Summary
 - **POO** – Opening Summary
 - **POP** – Post Summary
 - **POA** – Accessory Report
15. View, Print or Export a csv file from the Panel Layout Report – **REP**. Options include Openings, Reactions, Loads, Accessories and Statistics reports (Statistics report includes bottom plate lengths, wall surface square areas, wall perimeters and hold down quantities).

Panel Layout Report

Openings Reactions Loads Accessories Statistics Posts Beams Current View

| Type | Location | Floor | Quantity | Total Length (m) | Total Area (m ²) | Total Perimeter (m) |
|---------------------|----------|----------|----------|------------------|------------------------------|---------------------|
| Wall Panels: | | | | | | |
| Load bearing | External | Concrete | 12 | 43.64 | 105.61 | 145.36 |
| Non load bearing | Internal | Concrete | 13 | 31.09 | 75.23 | 125.10 |
| Openings: | | | | | | |
| Load bearing | External | Concrete | 12 | 17.92 | 23.22 | 67.24 |
| Non load bearing | Internal | Concrete | 7 | 7.08 | 14.87 | 43.56 |
| Bracing: | | | | | | |
| Load bearing | External | Concrete | 16 | 8.41 | | |
| Non load bearing | Internal | Concrete | 6 | 3.11 | | |
| HoldDowns: | | | | | | |
| Load bearing | External | Concrete | 12 | | | |
| Non load bearing | Internal | Concrete | 13 | | | |
| Beams: | | | | | | |

Print All Print Current Export Cancel

16. Go to the Panel Builder (**PPD**) to check Bill of Materials and Stud Design reports and to perform an initial check of panels prior to exporting.

...SAVE THE JOB...

4.13 Wall Panel and Beam Detailing

1. Walls and beams can now be exported from 'Layouts' space to 'Wall' Detail space through the Panel Builder (**PPD**). From within the Panel Builder you can view/export/print frame Fabrication elevations, Bill of Materials, Stud Design reports and Detail Design Drawings prior to exporting to CAD.

Note: Stud Design and Detail Design Drawings are not available for beams (webbed or otherwise) and ceiling panels as they are not engineered items.

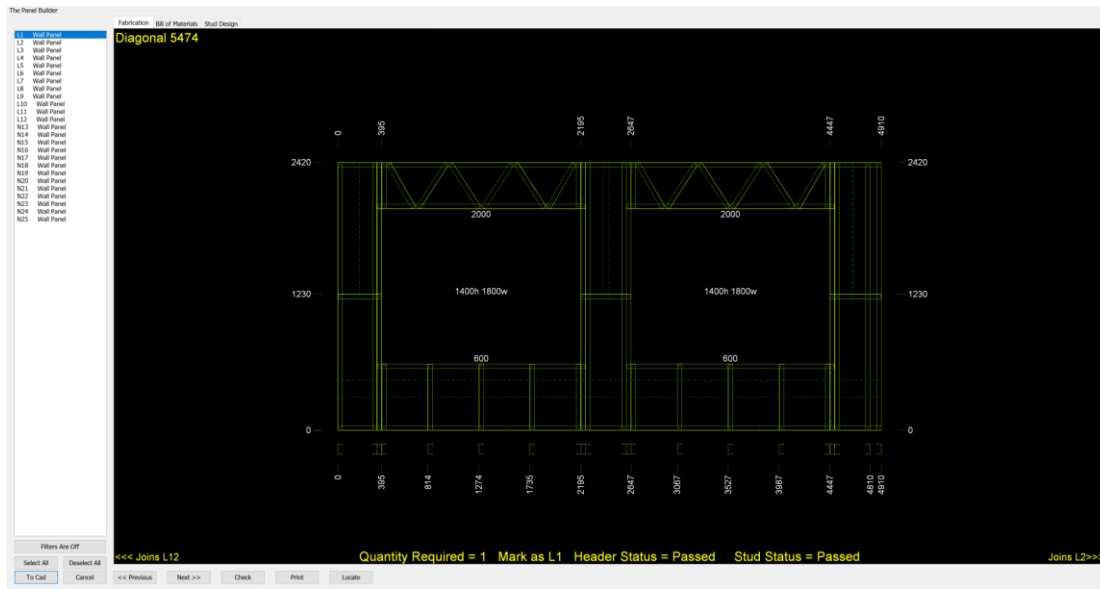

2. Click on 'Select All' and then 'To CAD' to export wall panels and beams. A new Detail space tab is created labelled 'Panel.1'.
3. Check all detailed panels as required:
 - View Restore (**VR**) to view the first view.
 - Next View (**VV**) to scroll through views.
4. Extra explicit tool (**ET**) operations can be added at this stage if required.
5. View, Print or Export a csv file from the Panel Usage Reports – **REP**
6. Create FRAMECAD RFY machine file (**RFY**).
7. Prior to printing the Wall Layout Plan, it may be worth considering turning off certain layers for clarity on site for the builders when erecting the frames. This can easily be done using the Visual Control (**VC**) command and de-selecting unnecessary layers, e.g. Studs, Openings, Opening Text and Bracing. 'Toggle Incidentals' will turn off/on all the listed items in the example.

A3D to see completed structure

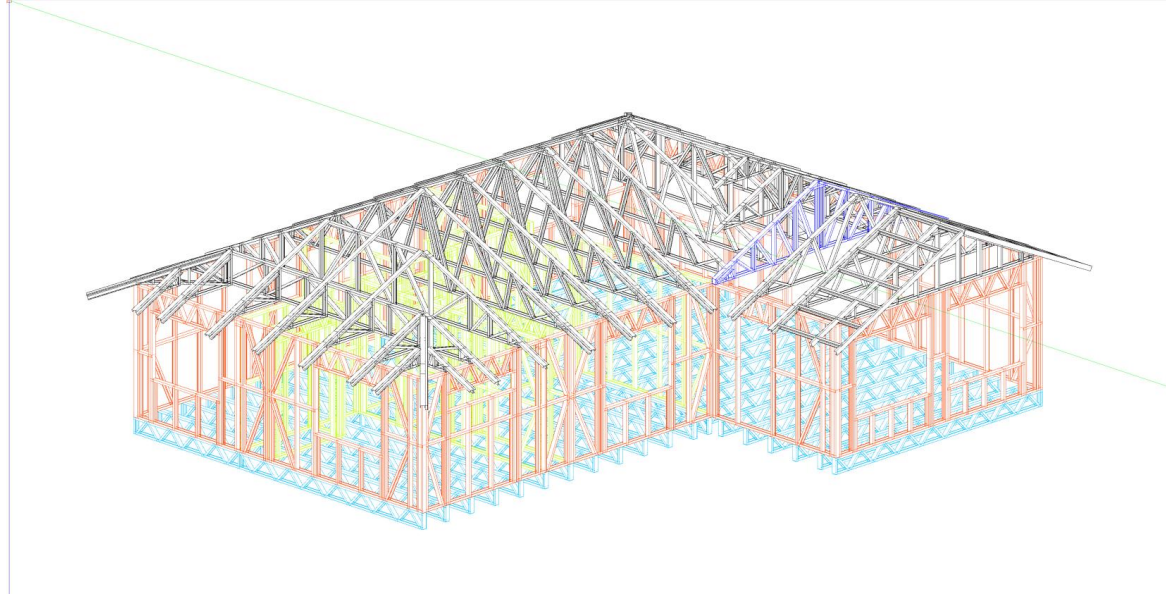

...SAVE THE JOB...

4.14 Wall Panel Engineering

Wall panel engineering results can only be accessed from the Wall Builder when using the **PPD** command from the layout plan only. From here you can view/export/print any required engineering information. Unlike trusses, walls modified in the elevation view cannot be re-engineered.

Note: Any manual modifications made to walls in the detail (elevation) view will void any engineering results.

4.15 Ceiling, Roof and Floor Panel Detailing (Smart Panels)

The smart panel function in Steelwise enables the user to create panels of any shape, pitch (less than 90°) and orientation.

Note: Smart panels are non-structural hence they are not engineered and loads are not transferred to any frames below. The PPD command only serves the purpose of building the frame of the panels.

4.15.1 Creating Ceiling Panels

1. Type SC then press Enter.

Command: SC

2. Press 'S' for settings, 'I' for interior boundary or select points for ceiling panel < P >...

3. Select 'S' to go to the Ceiling Panel settings in PSET if required.

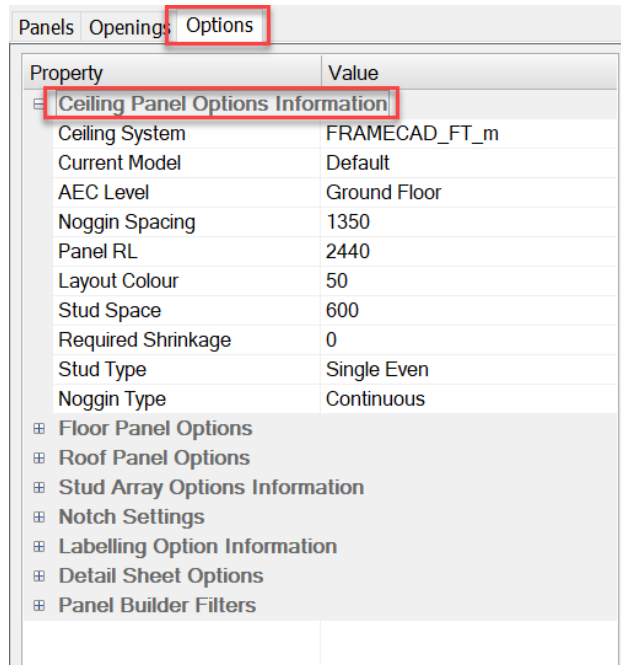

4. Make any changes and save.
5. Note: the RL height for ceiling panels is to the underside of the panel. Top and bottom RL heights can be edited when listing panels.
6. Select 'P' to input panel by points.
7. Select 'I' to input panel inside a polygon, closed polyline or any entities that form a closed area, e.g. wall frames of a room.
8. LI to list and edit any parameters of a ceiling panel.

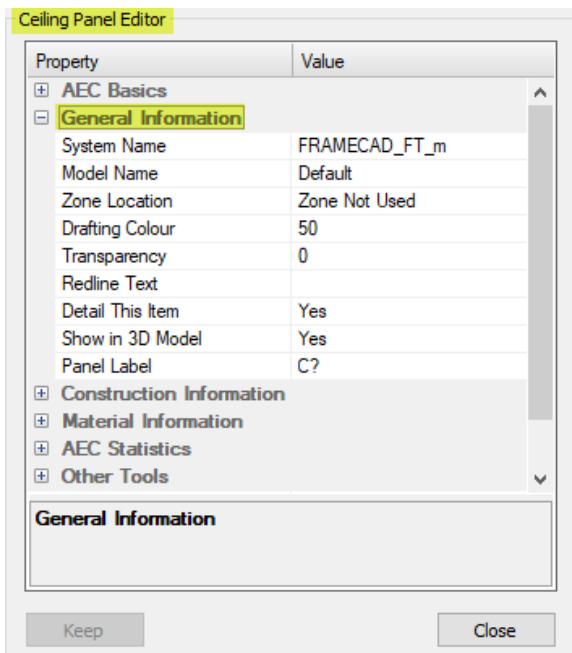
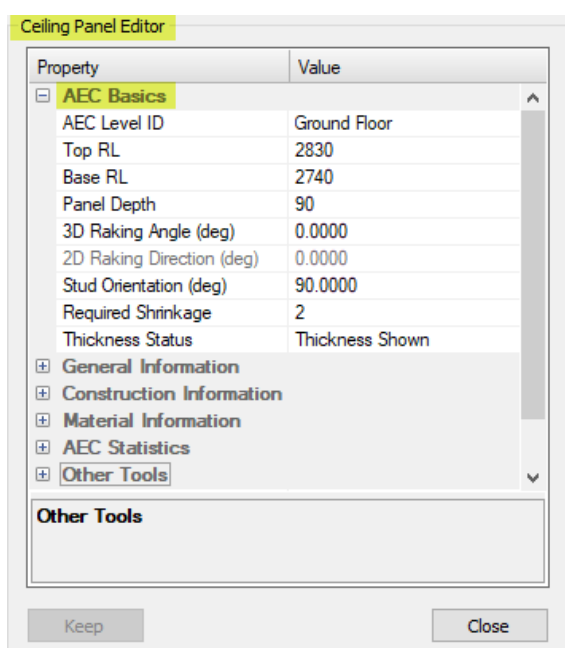

9. 3D Raking Angle determines the sloping pitch of the panel.
10. 2D Raking Direction determines the direction that the panel is sloped, and is only available if a 3D rake angle is present. There is a slope direction indicator arrow on the panel.
11. The Stud Orientation determines the stud member direction based on the plan layout orientation, i.e. 0° for horizontal and 90° for vertical.
12. Label and PPD to build with wall panels. Filters can be used in the Panel Builder to filter smart panels from wall panels if required.
13. OR Label and SPD to build smart panels separately from wall panels.
14. Panel framing will be built as a block.
15. Smart panels are placed on 'Panel Ceiling', 'Panel Roof' and 'Panel Floor' layers.

NOTE: Smart panels should not be created in the Model space as they will not work correctly.

4.15.2 Editing Ceiling Panels

1. In the detail space, double click anywhere on the panel block to edit members in the Block Editor.
 Note: A smart panel block can appear multiple times throughout a drawing. Generally, there will be one in the detail sheet, one in the layout and one in the model space. The same block can be accessed and edited from any one of these locations and all other instances of it will be affected the same.
2. 'Save Block' then 'Close Block Editor' to exit.
3. If 'Close Block Editor' is selected first, the user will be prompted to save.

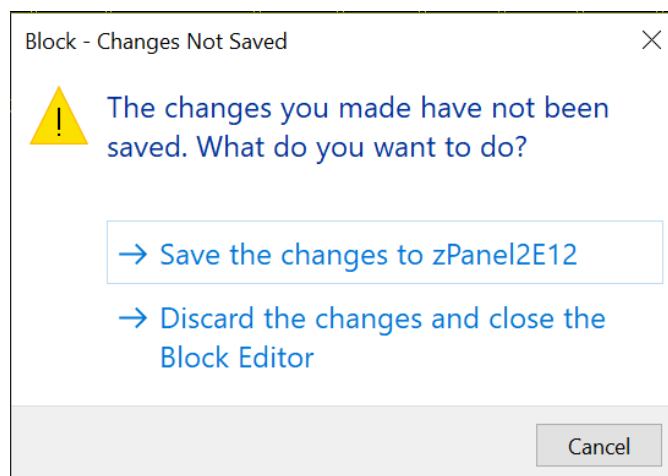

4. The panel Block Editor can also be accessed in the layout space by listing (LI) a panel and clicking on the 'Edit Panel - Press to Edit' button in 'Other Tools'.

| Other Tools | |
|--------------------------|------------------|
| Edit Panel | Press to Edit |
| Rebuild Blocks | Press to Rebuild |
| Convert to Polyline | Press to Convert |
| Convert to Ceiling Panel | Press to Convert |
| Convert to Floor Panel | Press to Convert |
| Insert Block | Press to Insert |
| Insert Block Insitu | Press to Insert |

- Blocks can also be displayed in the layout plan by clicking on the 'Insert Block Insitu - Press to Edit' button in 'Other Tools'.
- Insitu blocks are placed on 'Block Insert' layer. This make it easier to erase or freeze blocks on the layout.
- Additional stud setout options have been added for smart panels:

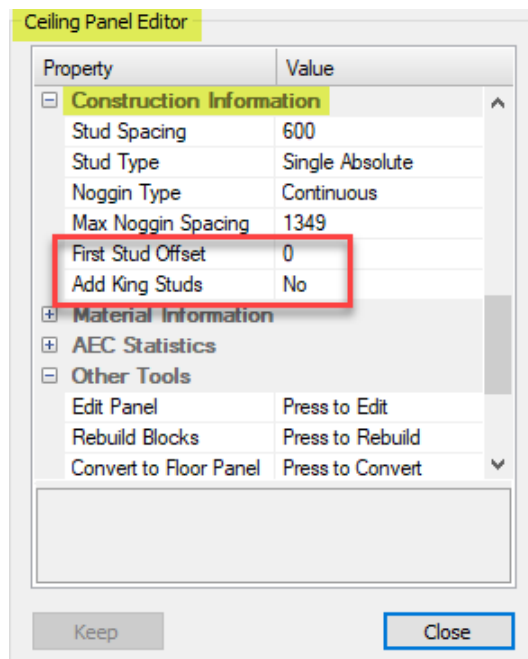

| Property | Value |
|---------------------------------|------------------|
| Construction Information | |
| Stud Spacing | 600 |
| Stud Type | Single Absolute |
| Noggin Type | Continuous |
| Max Noggin Spacing | 1349 |
| First Stud Offset | 0 |
| Add King Studs | No |
| Material Information | |
| AEC Statistics | |
| Other Tools | |
| Edit Panel | Press to Edit |
| Rebuild Blocks | Press to Rebuild |
| Convert to Floor Panel | Press to Convert |

- If the 'Stud Type' is set to use absolute spacing, then the 'First Stud Offset' can be applied. The offset distance is taken from the left-hand end of the panel to the centre of the first stud. If the 'Stud Type' is set to use even spacing, then the first stud offset will not be applied.
- The 'Add King Studs' option places a stud at every change of plate angle in complex shape panels.

4.16 Creating Roof and Floor Panels

Roof and floor panel creation is exactly the same as ceiling panels except that the RL height is to the top side of these panels.

- Type **SR** to input roof panels. RL is to the top of a roof panel.
- Type **SF** to input floor panels. RL is to the top of a floor panel.

As previously noted: Smart panels are non-structural hence they are not engineered and loads are not transferred to any frames below. The PPD/SPD command only serves the purpose of building the frame of the panels.

4.17 Other Commands

Printing Layouts

Type **SP**, and then select the appropriate printer, orientation and paper size.

Select the print method – Selected Borders, Selected Window, Auto Borders or Current Screen then click on 'GO' to print.

Select 'Cad Print' to go to the standard CAD print dialogue box.

Panel/Walls

P3D – 3D wall panels only.

PBS – Build Studs (no engineering)

PUA – Engineer walls and update studs.

PFB – Opening to Brick. Allows an opening to be placed at specified brick module distances from a defined location.

PLB – Laps a beam over the end or side of a wall frame by a given distance.

PBN – Bath Nog.

PSN – Special Noggin.

PST – Create a panel stack in an empty border for transportation purposes. Height of stack = width of the truck if panels are stacked vertically.

S3D – 3D smart panels only.

Trusses

FFIND – Enter a label name to find truss on the plan.

T3D – 3D trusses only.

TRE – Rebuild Eaves. If truss eaves overhangs have been deleted, this command will rebuild them.

Floor Joists

FD – Tool used to input a complete floor system including piles, bearers, joists, and flooring.

FSD – Floor Sheet Draw (inputs a floor sheet layout).

J3D – 3D joists only.

Miscellaneous

ID – Insert Detail

Layers

LS – Show All Layers

LF – Freeze a layer

LE – Erase a layer

LX – Add a temporary layer – (also used to add items to the temporary layer). An architect's plan is usually used as a temporary layer to be able to trace the detailed plan over.

LT – Toggle temporary layer on or off

5 Steelwise Menu & Commands

Refer to the Steelwise Reference Guide for more detailed information on each command. Go to Reference Guide in the Steelwise Help menu.

Steelwise:

| | |
|---|-------------------|
| Detail/Frame Builder | DET (TTD/PPD/JJD) |
| Framing Item / Member Item | ADD |
| List Item | LI |
| Reset CAD Environment | DO_ONCE |
| Reset All (Reset program to default settings) | RESETALL |
| Software Version | VER |
| Spool Print | SP |
| BIM Attach | BIMATTACH |

Settings:

| | |
|----------------|------|
| Border Setup | BSET |
| Floor Settings | JSET |
| Panel Settings | PSET |
| Truss Settings | TSET |

Panels/Walls:

| | |
|--------------------------------|------------------|
| Bath Nog | PBN |
| Build Studs | PBS |
| Calculate Bracing | PCB |
| Defined Door Input | <i>See Below</i> |
| Insert Brace | PIB |
| Lap Beam | PLB |
| Load Path | LP |
| Opening Input | ADD |
| Opening to Brick | PFB |
| Panel Auto Break | PAB |
| Panel Builder | PPD (or DET) |
| Panel Builder (Silent) | -PPD |
| Panel Input | PD (or ADD) |
| Panel Rake | PRA |
| Panel Stack | PST |
| Show Brick | SB |
| Show Heights | SH |
| Special Noggin | PSN |
| Stud Array | PSA |
| Stud Array Copy | PSC |
| Update All (Re-Engineer Walls) | PUA |
| User Defined Door | UD |
| User Defined Window | UW |

Defined Door Input:

| | |
|------------------------------|----|
| Aluminium Door | AD |
| Aluminium Window | AW |
| Archway Opening (Square Set) | AR |
| Cavity Slider | CS |
| External Door | ED |
| Face Slider | FS |
| Passage Door | PA |
| Robe Door x1 | R1 |
| Robe Door x2 | R2 |
| Robe Door x3 | R3 |
| Internal Slider x2 | S2 |
| Internal Slider x3 | S3 |
| Internal Slider x4 | S4 |

Trusses:

| | |
|--|--------------|
| Add Point Load | TPL |
| Add Support | AS |
| Box Gutter | BG |
| Box Member | BM |
| Code Member | CM |
| Code Roof Line | RL |
| Code Support Line | SL |
| Convert to Hexagonal End | CTH |
| Create Roof Lines | CRL |
| Insert Web | IW |
| Rebuild Eaves | TRE |
| Roof Shape Input | RS |
| Solar Panel | TS |
| Truss Builder | TTD (or DET) |
| Truss Builder (Silent – Re-engineers without going to Truss Builder) | -TTD |
| Truss Layout Input | TD |
| Truss Uplift Plan | TUP |

Joists:

| | |
|---------------------|--------------|
| Code Support Line | SL |
| Floor Recess | FR |
| Floor Sheet Input | FSD |
| Floor System Wizard | FD |
| Joist Builder | JJD (or DET) |
| Joist Layout Input | JD (or ADD) |
| Joist Service Hole | JSH |

Smart Panel:

| | |
|---------------|-----|
| Ceiling Panel | SC |
| Floor Panel | SF |
| Roof Panel | SR |
| Panel Builder | SPD |

Editing:

| | |
|-------------------------|----------|
| Add Support | AS |
| Box Member | BM |
| Break Member | MB |
| Copy | C |
| Copy Layer | CL |
| Crossing Member | MX |
| Cut Member | MC |
| Divide Member | MD |
| Extend Member | ME |
| Fillet Member | MF |
| Inherit Properties | IP |
| Insert Web | IW |
| Join Member | MJ |
| Lengthen Member | ML |
| Mirror Member | MI |
| Move Member | M |
| Offset Member | MO |
| Update Member | MU |
| Reverse Frame or Member | RF or MR |
| Section Mark | SM |
| Special Erase | SE |

Miscellaneous:

| | |
|----------------------|-------|
| Centered | CTR |
| Copy Posts | CC |
| Copy View | CV |
| Create Support Lines | CSL |
| Explicit Tool | ET |
| Find Item | FFIND |
| Gridline | GL |
| Insert Detail | ID |
| Integrity Check | IC |
| Label All | LA |
| List Item | LI |
| Quick Text Input | QT |
| Reference Point | REF |
| Revision Cloud | REV |

| | |
|--|-------|
| Show Orientation or Engineering Failures | SHOW |
| Steel Profiles | SS |
| Strip Data | STRIP |

Dimension:

| | |
|----------------------|----|
| Aligned Dimension | DA |
| Dimension Guidelines | DG |
| Horizontal Dimension | DH |
| Line Dimension | DL |
| Linear Dimension | DM |
| Ordinate Dimension | DO |
| Vertical Dimension | DV |

Reports:

| | |
|---------------------------|-----|
| Beam Summary | POB |
| On Page Joist Accessories | JOA |
| On Page Opening Summary | POO |
| On Page Panel Accessories | POA |
| On Page Panel Summary | POS |
| On Page Post Summary | POP |
| On Page Rafter Summary | ROS |
| On Page Roof Area | RA |
| On Page Summary | OR |
| On Page Truss Accessories | TOA |
| On Page Truss Summary | TOS |
| Report | REP |
| Summary Report | SUM |

View:

| | |
|-----------------------------|-------------|
| All Layouts 3D | A3D (or 3D) |
| Copy View | CV |
| Go To View... | V |
| Initial View (View Restore) | VR |
| Joist 3D | J3D |
| Layout / Detail Toggle | ZZ |
| Make View | VM |
| Move View | MV |
| Next View | VV |
| Wall Panel 3D | P3D |
| Previous View | VP |
| Smart Panel 3D | S3D |
| Truss 3D | T3D |

Layer Control:

| | |
|---------------------------------|------------|
| Copy Layer | CL |
| Current Layer | LC |
| Erase Layer | LE |
| Freeze Layer | LF |
| Isolate Layer | IL |
| Layer Show All | LS |
| Temp Layer Add | LX |
| Temp Layer 1 to 5 Add | LX1,...LX5 |
| Temp Layer Toggle On/Off | LT |
| Temp Layer 1 to 5 Toggle On/Off | LT1,...LT5 |
| Visual Controls | VC |

Exports:

| | |
|-----------------|--------|
| ACNC Export All | ACNC |
| CNC Export | CNC |
| Export As... | EXPORT |
| IFC Export | IFC |
| PDF Export | PDF |
| RFY Export | RFY |
| STP Export | STP |
| VRML Export | VRML |

Help:

| | |
|----------------------|-----|
| Engineering Guide | |
| Procedures Guide | |
| Reference Guide | |
| Release Notes | |
| Software Version | VER |
| Updates and How To's | |

Refer to the Steelwise Reference Guide for more detailed information on each command. Go to Reference Guide in the Steelwise Help menu.

6 Appendix A

6.1 Tutorial Drawing

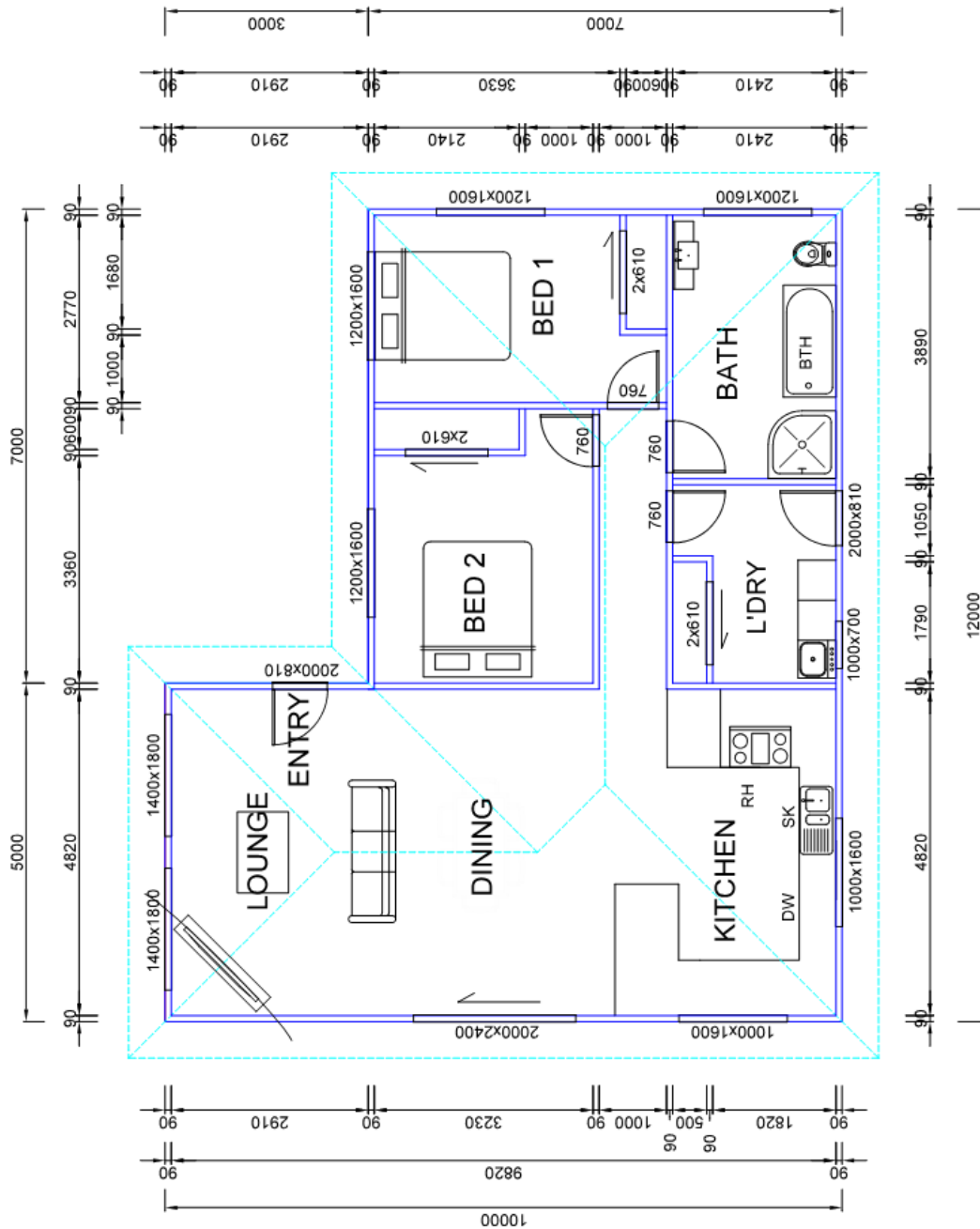

6.2 Tutorial Outputs

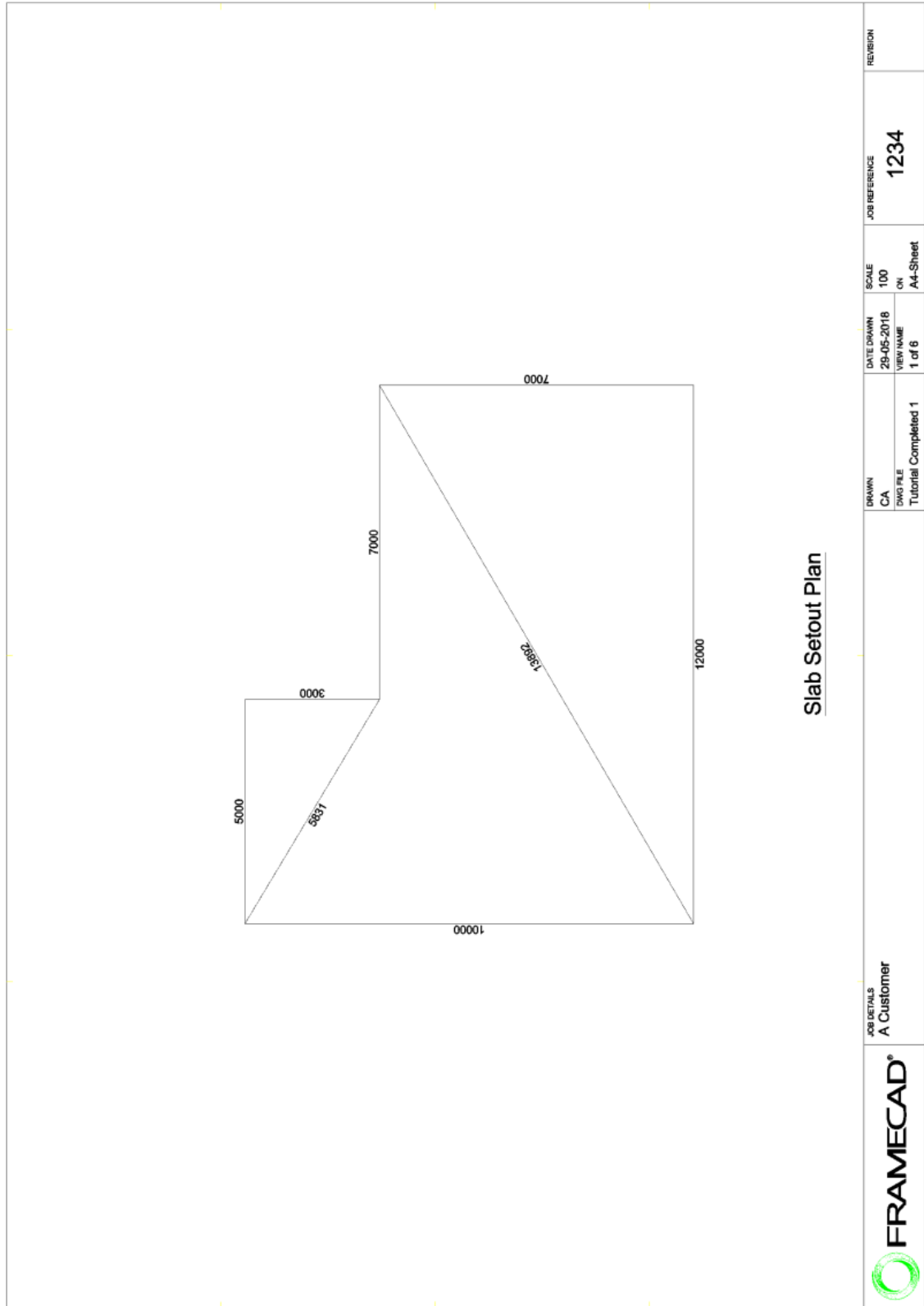

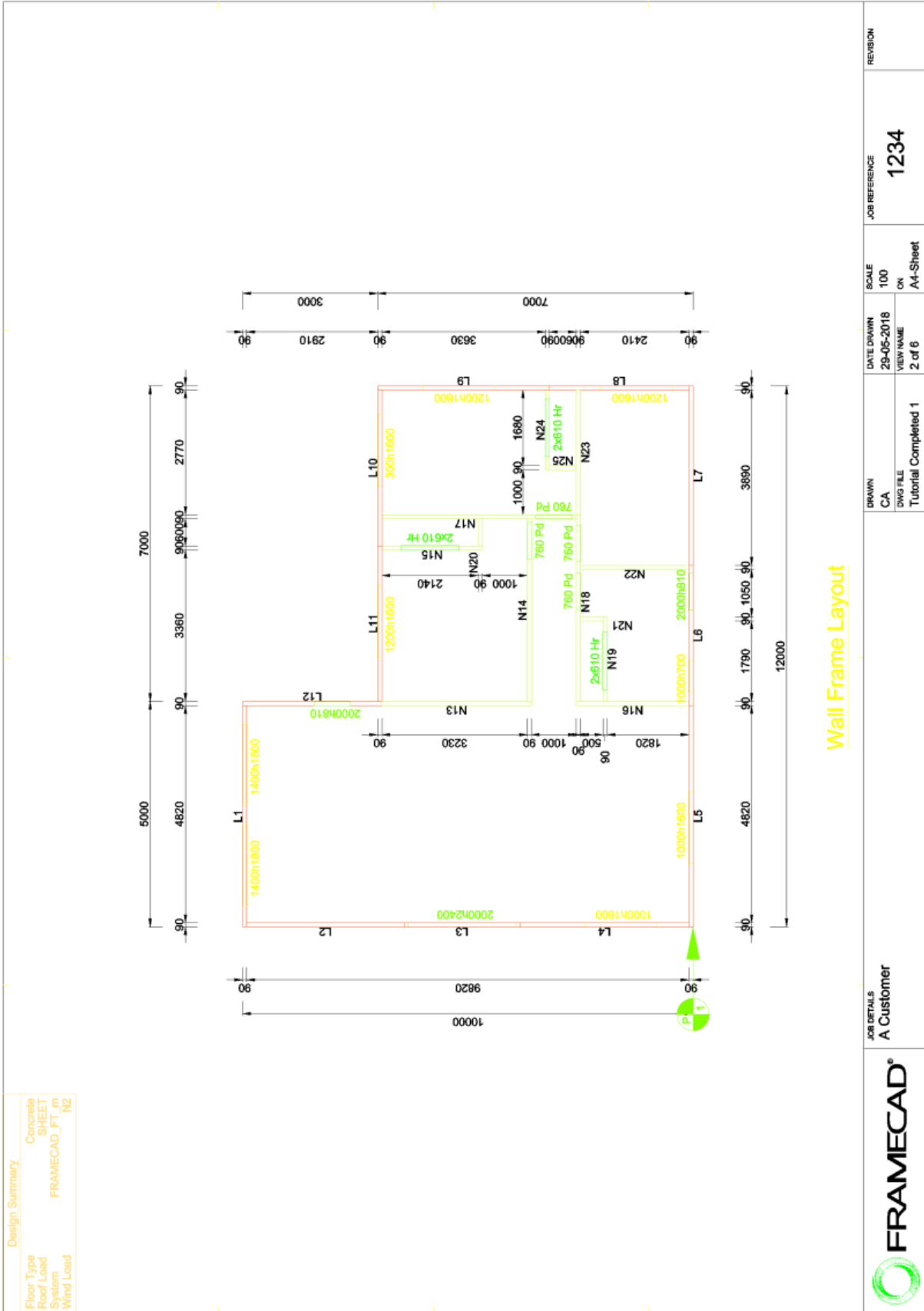

Wall Frame Layout

| | |
|----------------|---------------|
| Design Summary | |
| Floor Type | Concrete |
| Roof Load | SHEET |
| System | FRAMECAD_FT_m |
| Wind Load | N2 |

| | | | |
|---------------------------|----------------------------------|--------------------------|----------|
| JOB DETAILS A Customer | FRAMECAD® | JOB REFERENCE 1234 | REVISION |
| | | SCALE 100 ON A4-Sheet | |
| | DRAWN CA | DATE DRAWN 29-05-2018 | |
| | DWG FILE Tutorial Completed 1 | VIEW NAME 2 of 6 | |

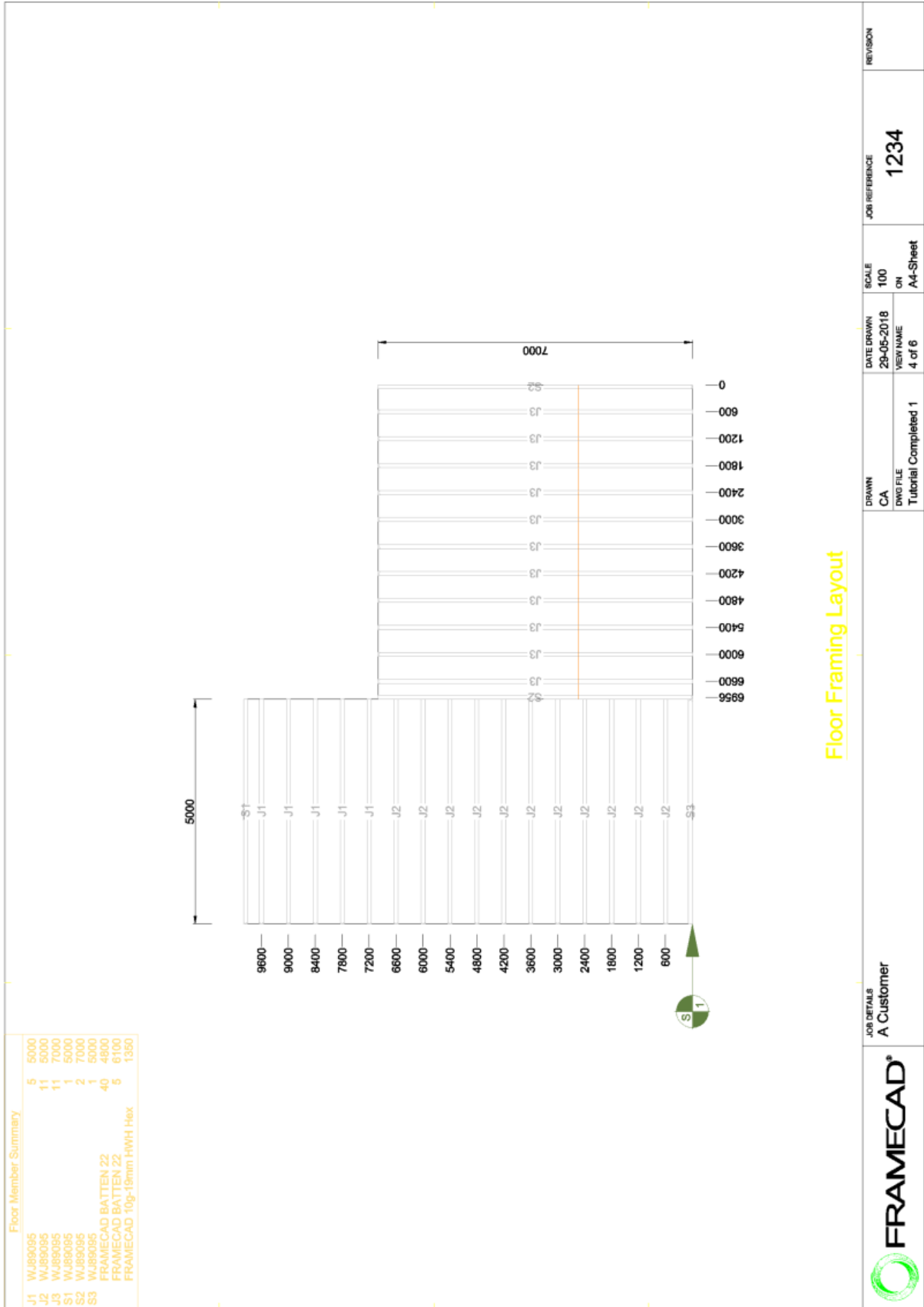

Floor Member Summary

| | | | |
|----|---------------------------|----|------|
| J1 | WJ.B90095 | 5 | 5000 |
| J2 | WJ.B90095 | 11 | 5000 |
| J3 | WJ.B90095 | 11 | 7000 |
| S1 | WJ.B90095 | 1 | 5000 |
| S2 | WJ.B90095 | 2 | 7000 |
| S3 | WJ.B90095 | 1 | 5000 |
| | FRAMECAD BATTEN 22 | 40 | 4800 |
| | FRAMECAD BATTEN 22 | 5 | 6100 |
| | FRAMECAD 10g-19mm HWH Hex | 5 | 1350 |

Floor Framing Layout

| | | | | | | |
|--|---------------------------|---|---|--------------------------------|-----------------------|----------|
| | JOB DETAILS A Customer | DRAWN CA DWG FILE Tutorial Completed 1 | DATE DRAWN 29-05-2018 VIEW NAME 4 of 6 | SCALE 100 ON A4-Sheet | JOB REFERENCE 1234 | REVISION |
|--|---------------------------|---|---|--------------------------------|-----------------------|----------|

